

# TABLE OF CONTENTS

<b>1</b>	<b>INTRODUCTION</b> .....	<b>3</b>
<b>2</b>	<b>THINGS TO KNOW BEFORE STARTING YOUR VEHICLE</b> .....	<b>7</b>
<b>3</b>	<b>UNDERSTANDING THE FEATURES OF YOUR VEHICLE</b> .....	<b>71</b>
<b>4</b>	<b>UNDERSTANDING YOUR INSTRUMENT PANEL</b> .....	<b>193</b>
<b>5</b>	<b>STARTING AND OPERATING</b> .....	<b>251</b>
<b>6</b>	<b>WHAT TO DO IN EMERGENCIES</b> .....	<b>325</b>
<b>7</b>	<b>MAINTAINING YOUR VEHICLE</b> .....	<b>343</b>
<b>8</b>	<b>MAINTENANCE SCHEDULES</b> .....	<b>387</b>
<b>9</b>	<b>IF YOU NEED CONSUMER ASSISTANCE</b> .....	<b>401</b>
<b>10</b>	<b>INDEX</b> .....	<b>407</b>

---



# SECTION 1

## INTRODUCTION

- INTRODUCTION ..... 4
- HOW TO USE THIS MANUAL ..... 4
- WARNINGS AND CAUTIONS ..... 6
- VEHICLE IDENTIFICATION NUMBER ..... 6
- VEHICLE MODIFICATIONS/ALTERATIONS ..... 6

## INTRODUCTION

### INTRODUCTION

Congratulations on selecting your new Chrysler Group LLC vehicle. Be assured that it represents precision workmanship, distinctive styling, and high quality - all essentials that are traditional to our vehicles.

This Owner's Manual has been prepared with the assistance of service and engineering specialists to acquaint you with the operation and maintenance of your vehicle. It is supplemented by Warranty Information, and various customer-oriented documents. Please take the time to read these publications carefully. Following the instructions and recommendations in this manual will help assure safe and enjoyable operation of your vehicle.

**NOTE: After reviewing the owner information, it should be stored in the vehicle for convenient referencing and remain with the vehicle when sold.**

When it comes to service, remember that your authorized dealer knows your vehicle best, has factory-trained technicians and genuine MOPAR® parts, and cares about your satisfaction.

### HOW TO USE THIS MANUAL

Consult the Table of Contents to determine which section contains the information you desire.

Since the specification of your vehicle depends on the items of equipment ordered, certain descriptions and illustrations may differ from your vehicle's equipment





















































































The detailed index at the back of this Owner's Manual contains a complete listing of all subjects.

Consult the following table for a description of the symbols that may be used on your vehicle or throughout this Owner's Manual:



INTRODUCTION

art=010533317.tif TRANSLATE

											
WATER IN FUEL	REAR WINDOW WIPER	WINDSHIELD WIPER INTERMITTENT	EXTERIOR BULB FAILURE	HIGH BEAM	TURN SIGNALS	UPPER AIR OUTLET	HEATED SEAT LOW	DOOR LOCK	ADJUSTABLE PEDALS	ELECTRONIC SPEED CONTROL	ELECTRONIC STABILITY PROGRAM / BRAKE ASSIST SYSTEM
											
FUEL	REAR WINDOW INTERMITTENT WIPER	WINDSHIELD WASHER	MASTER LIGHTING SWITCH	LOW BEAM	KEY ACTIVATE (POWER OUTLET)	UPPER AND LOWER AIR OUTLET	HEATED SEAT HIGH	WINDOW LIFT	TIRE PRESSURE MONITOR	HILL DESCENT CONTROL	BRAKE SYSTEM WARNING PARKING BRAKE
											
FUEL FILL SIDE	REAR WINDOW WASHER	WINDSHIELD WASHER FLUID LEVEL	DOME LIGHT	FRONT FOG LIGHT	HOOD RELEASE	LOWER AIR OUTLET	RECIRCULATION	CONVERTIBLE 4 WINDOW DOWN	ELECTRONIC STABILITY CONTROL	AWD!	FAILURE OF ANTILOCK BRAKING SYSTEM
											
ENGINE OIL	REAR WINDOW DEFROST	WINDSHIELD ELECTRICALLY HEATED	PARK LIGHTS	REAR FOG LAMP	LIFTGATE RELEASE AND LIFTGATE OPEN	DEFROST AND LOWER AIR OUTLET	VENTILATING FAN	WINDOW LOCK	ELECTRONIC THROTTLE CONTROL	4WD!	BRAKE SYSTEM WARNING PARKING BRAKE
											
BATTERY CHARGING	HEATED MIRROR	WINDSHIELD DEFROST	INSTRUMENT PANEL ILLUMINATION	SEAT BELT	SLIDING DOOR	TRUNK / DECK RELEASE	AIR CONDITIONING	CHILD SEAT TETHER ANCHOR	VOICE RECOGNITION BUTTON	WARNING	TOW / HAUL
											
GLOW PLUG	POWER STEERING FLUID	WINDSHIELD WIPER AND WASHER	SIDE AIRBAG	AIRBAG	SLIDING DOOR	EMERGENCY RELEASE HANDLE	LIGHTER	LOWER ANCHORS AND TETHER FOR CHILDREN (LATCH)	UCONNECT™ BUTTON	HAZARD	4 LOW FOUR WHEEL DRIVE LOW
											
MALFUNCTION INDICATOR LIGHT	TRANS OIL TEMP	ENGINE COOLANT TEMPERATURE	SRS AIRBAG	PASSENGER AIRBAG OFF	DOOR AJAR	CONVERTIBLE TOP DOWN	CONVERTIBLE TOP UP	HORN	SEE OWNER'S MANUAL ISO	A/C PUSH	ELECTRONIC STABILITY CONTROL OFF

010533317

## INTRODUCTION

### WARNINGS AND CAUTIONS

This Owners Manual contains **WARNINGS** against operating procedures that could result in a collision or bodily injury. It also contains **CAUTIONS** against procedures that could result in damage to your vehicle. If you do not read this entire Owners Manual, you may miss important information. Observe all Warnings and Cautions.

### VEHICLE IDENTIFICATION NUMBER

The Vehicle Identification Number (VIN) is on the left front corner of the instrument panel and is visible from outside of the vehicle through the windshield. This number also appears on the Automobile Information Disclosure Label affixed to a window on your vehicle, the vehicle registration, and the title.

art=010807223.tif NO TRANS

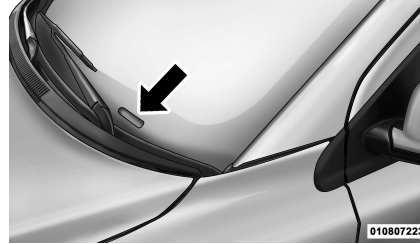

VIN Location

**NOTE:** *It is illegal to remove or alter the VIN.*

### VEHICLE MODIFICATIONS/ ALTERATIONS

#### WARNING!

**Any modifications or alterations to this vehicle could seriously affect its roadworthiness and safety and may lead to an accident resulting in serious injury or death.**

# SECTION 2

## THINGS TO KNOW BEFORE STARTING YOUR VEHICLE

• A WORD ABOUT YOUR KEYS . . . . .	9	• Programming Additional Transmitters . . . . .	17
• Keyless Ignition Node (KIN) . . . . .	9	• Transmitter Battery Replacement . . . . .	17
• Key Fob . . . . .	9	• General Information . . . . .	18
• Ignition Or Accessory On Message . . . . .	10	• REMOTE STARTING SYSTEM — IF EQUIPPED . . . . .	18
• SENTRY KEY® . . . . .	11	• How To Use Remote Start . . . . .	19
• Replacement Keys . . . . .	12	• DOOR LOCKS . . . . .	21
• Customer Key Programming . . . . .	12	• Manual Door Locks . . . . .	21
• General Information . . . . .	12	• Power Door Locks . . . . .	21
• VEHICLE SECURITY ALARM — IF EQUIPPED . . . . .	13	• Child-Protection Door Lock System — Rear Doors . . . . .	23
• Rearming Of The System . . . . .	13	• KEYLESS ENTER-N-GO . . . . .	24
• To Arm The System . . . . .	13	• WINDOWS . . . . .	27
• To Disarm The System . . . . .	14	• Power Windows . . . . .	27
• ILLUMINATED ENTRY . . . . .	15	• Wind Buffeting . . . . .	29
• REMOTE KEYLESS ENTRY (RKE) . . . . .	15	• LIFTGATE . . . . .	29
• To Unlock The Doors And Liftgate . . . . .	15	• OCCUPANT RESTRAINTS . . . . .	30
• To Lock The Doors And Liftgate . . . . .	16	• Lap/Shoulder Belts . . . . .	33
• Remote Open Window Feature . . . . .	16	• Lap/Shoulder Belt Untwisting Procedure . . . . .	37
• Using The Panic Alarm . . . . .	17		

**THINGS TO KNOW BEFORE STARTING YOUR VEHICLE**

• Seat Belts In Passenger Seating Positions . . . .	37	• Advanced Front Airbag Features . . . . .	46
• Automatic Locking Retractor Mode (ALR) — If Equipped . . . . .	38	• Airbag Deployment Sensors And Controls . . . .	49
• Energy Management Feature . . . . .	39	• Event Data Recorder (EDR) . . . . .	54
• Seat Belt Pretensioners . . . . .	39	• Child Restraints . . . . .	55
• Supplemental Active Head Restraints (AHR) . . .	39	• ENGINE BREAK-IN RECOMMENDATIONS . . . . .	65
• Enhanced Seat Belt Use Reminder System (BeltAlert®) . . . . .	42	• SAFETY TIPS . . . . .	65
• Seat Belts And Pregnant Women . . . . .	43	• Transporting Passengers . . . . .	65
• Seat Belt Extender . . . . .	44	• Exhaust Gas . . . . .	66
• Supplemental Restraint System (SRS) — Airbags . . . . .	44	• Safety Checks You Should Make Inside The Vehicle . . . . .	67
		• Periodic Safety Checks You Should Make Outside The Vehicle . . . . .	68

**THINGS TO KNOW BEFORE STARTING YOUR VEHICLE**

**A WORD ABOUT YOUR KEYS**

Your vehicle uses a keyless ignition system. This system consists of a Key Fob with Remote Keyless Entry (RKE) transmitter and a Keyless Ignition Node (KIN).

**Keyless Enter-N-Go Feature**

This vehicle is equipped with the Keyless Enter-N-Go feature, refer to “Starting Procedure” in “Starting And Operating” for further information.

**Keyless Ignition Node (KIN)**

This feature allows the driver to operate the ignition switch with the push of a button, as long as the Remote Keyless Entry (RKE) transmitter is in the passenger compartment.

The Keyless Ignition Node (KIN) has four operating positions, three of which are labeled and will illuminate when in posi-

tion. The three positions are OFF, ACC, and ON/RUN. The fourth position is START, during start RUN will illuminate.

**NOTE:** *In case the ignition does not change with the push of a button, the RKE transmitter (Key Fob) may have a low or dead battery. In this situation a back up method can be used to operate the ignition switch. Put the nose side (side opposite of the emergency key) of the Key Fob against the ENGINE START/STOP button and push to operate the ignition switch.*

art=020236152.tif NO TRANS

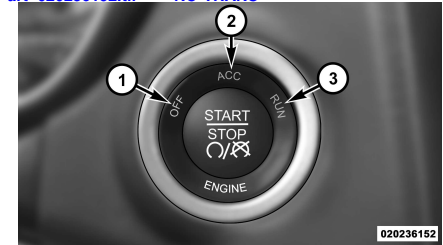

**Keyless Ignition Node (KIN)**

- 1 — OFF
- 2 — ACC (ACCESSORY)
- 3 — ON/RUN

**Key Fob**

The Key Fob also contains the Remote Keyless Entry (RKE) transmitter and an emergency key, which stores in the rear of the Key Fob.

## THINGS TO KNOW BEFORE STARTING YOUR VEHICLE

The emergency key allows for entry into the vehicle should the battery in the vehicle or the Key Fob go dead. The emergency key is also for locking the glove box. You can keep the emergency key with you when valet parking.

To remove the emergency key, slide the mechanical latch on the back of the Key Fob sideways with your thumb and then pull the key out with your other hand.

art=020235340.tif NO TRANS



020235340

### Emergency Key Removal

**NOTE:** You can insert the double-sided emergency key into the lock cylinders with either side up.

### Ignition Or Accessory On Message

Opening the driver's door when the ignition is in ACC or ON (engine not running), a chime will sound to remind you to cycle the ignition to OFF. In addition to the chime, the ignition or accessory on message will display in the cluster.

**NOTE:** With the Uconnect Touch™ system, the power window switches, radio, power sunroof (if equipped), and power outlets will remain active for up to 10 minutes after the ignition is cycled to the OFF position. Opening either front door will cancel this feature. The time for this feature is programmable. Refer to "Uconnect Touch™ Settings" in "Understanding Your Instrument Panel" for further information.

**THINGS TO KNOW BEFORE STARTING YOUR VEHICLE**

**WARNING!**

- **Never leave children alone in a vehicle. Leaving unattended children in a vehicle is dangerous for a number of reasons. A child or others could be seriously or fatally injured. Do not leave the ignition in the ACC or RUN position. A child could operate power windows, other controls, or move the vehicle.**
- **Do not leave children or animals inside parked vehicles in hot weather. Interior heat build-up may cause serious injury or death.**

**CAUTION!**

**An unlocked car is an invitation to thieves. Always remove the Key Fob from vehicle, cycle the ignition OFF and lock all doors when leaving the vehicle unattended.**

**SENTRY KEY®**

The Sentry Key® Immobilizer system prevents unauthorized vehicle operation by disabling the engine. The system does not need to be armed or activated. Operation is automatic, regardless of whether the vehicle is locked or unlocked.

The system uses a Key Fob with Remote Keyless Entry (RKE) transmitter, a Keyless Ignition Node (KIN) and a RF receiver to prevent unauthorized vehicle operation. Therefore, only Key Fobs that are pro-

grammed to the vehicle can be used to start and operate the vehicle.

After cycling the ignition switch to the ON/RUN position, the Vehicle Security Light will turn on for three seconds for a bulb check. If the light remains on after the bulb check, it indicates that there is a problem with the electronics. In addition, if the light begins to flash after the bulb check, it indicates that someone used an invalid Key Fob to start the engine. Either of these conditions will result in the engine being shut off after two seconds.

If the Vehicle Security Light turns on during normal vehicle operation (vehicle running for longer than 10 seconds), it indicates that there is a fault in the electronics. Should this occur, have the vehicle serviced as soon as possible by an authorized dealer.

**THINGS TO KNOW BEFORE STARTING YOUR VEHICLE**

**CAUTION!**

**The Sentry Key® Immobilizer system is not compatible with some after-market remote starting systems. Use of these systems may result in vehicle starting problems and loss of security protection.**

All of the Key Fobs provided with your new vehicle have been programmed to the vehicle electronics.

**Replacement Keys**

**NOTE:** *Only Key Fobs that are programmed to the vehicle electronics can be used to start and operate the vehicle. Once a Key Fob is programmed to a vehicle, it cannot be programmed to any other vehicle.*

**CAUTION!**

**Always remove the keys from the vehicle and lock all doors when leaving the vehicle unattended.**

At the time of purchase, the original owner is provided with a four-digit Personal Identification Number (PIN). Keep the PIN in a secure location. This number is required for authorized dealer replacement of Key Fobs. Duplication of Key Fobs may be performed at an authorized dealer, this procedure consists of programming a blank Key Fob to the vehicle electronics. A blank Key Fob is one that has never been programmed.

**NOTE:** *When having the Sentry Key® Immobilizer system serviced, bring all vehicle Key Fobs with you to an authorized dealer.*

**Customer Key Programming**

Programming Key Fobs or RKE transmitters may be performed at an authorized dealer.

**General Information**

The Sentry Key® system complies with FCC rules Part 15 and with RSS-210 of Industry Canada. Operation is subject to the following conditions:

- This device may not cause harmful interference.



---

## THINGS TO KNOW BEFORE STARTING YOUR VEHICLE

- This device must accept any interference that may be received, including interference that may cause undesired operation.

### VEHICLE SECURITY ALARM — IF EQUIPPED

The Vehicle Security Alarm monitors the vehicle doors and liftgate for unauthorized entry and the Keyless Enter-N-Go Start/Stop button for unauthorized operation. While the Vehicle Security Alarm is armed, interior switches for door locks are disabled. If something triggers the alarm, the Vehicle Security Alarm will prevent the vehicle from starting and provide the following audible and visible signals: the horn will pulse, the headlights, park lamps and/or turn signals will flash, and the Vehicle Security Light in the instrument cluster will flash.

#### Rearming Of The System

If something triggers the alarm, and no action is taken to disarm it, the Vehicle Security Alarm will turn the horn off after three minutes, turn all of the visual signals off after 15 additional minutes, and then the Vehicle Security Alarm will rearm itself.

#### To Arm The System

Follow these steps to arm the theft alarm:

1. Remove the key from the ignition system (refer to "Starting Procedures" in "Starting And Operating" for further information).

- For vehicles equipped with Keyless Enter-N-Go, make sure the vehicle ignition system is "OFF".
- For vehicles not equipped with Keyless Enter-N-Go, make sure the vehicle ignition

system is "OFF" and the key is physically removed from the ignition.

2. Perform one of the following methods to lock the vehicle:

- Press LOCK on the interior power door lock switch with the driver and/or passenger door open.
- Press the LOCK button on the exterior Passive Entry Door Handle with a valid Key Fob available in the same exterior zone (refer to "Keyless Enter-N-Go" in "Things To Know Before Starting Your Vehicle" for further information).
- Press the LOCK button on the Remote Keyless Entry (RKE) transmitter.

3. If any doors are open, close them.

## THINGS TO KNOW BEFORE STARTING YOUR VEHICLE

### To Disarm The System

The Vehicle Security Alarm can be disarmed using any of the following methods:

- Press the UNLOCK button on the Remote Keyless Entry (RKE) transmitter.
- Grasp the Passive Entry Unlock Door Handle (if equipped, refer to "Keyless Enter-N-Go" in "Things To Know Before Starting Your Vehicle" for further information).
- Cycle the vehicle ignition system out of the OFF position.
- For vehicles equipped with Keyless Enter-N-Go, press the Keyless Enter-N-Go Start/Stop button (requires at least one valid Key Fob in the vehicle).

- For vehicles not equipped with Keyless Enter-N-Go, insert a valid key into the ignition switch and turn the key to the ON position.

### NOTE:

- *The driver's door key cylinder and the liftgate button on the RKE transmitter cannot arm or disarm the Vehicle Security Alarm.*
- *The Vehicle Security Alarm remains armed during power liftgate entry. Pressing the liftgate button will not disarm the Vehicle Security Alarm. If someone enters the vehicle through the liftgate and opens any door the alarm will sound.*
- *When the Vehicle Security Alarm is armed, the interior power door lock switches will not unlock the doors.*

The Vehicle Security Alarm is designed to protect your vehicle; however, you can create conditions where the system will give you a false alarm. If one of the previously described arming sequences has occurred, the Vehicle Security Alarm will arm regardless of whether you are in the vehicle or not. If you remain in the vehicle and open a door, the alarm will sound. If this occurs, disarm the Vehicle Security Alarm.

If the Vehicle Security Alarm is armed and the battery becomes disconnected, the Vehicle Security Alarm will remain armed when the battery is reconnected; the exterior lights will flash, the horn will sound. If this occurs, disarm the Vehicle Security Alarm.

**THINGS TO KNOW BEFORE STARTING YOUR VEHICLE**

**Tamper Alert**

If something has triggered the Vehicle Security Alarm in your absence, the horn will sound three times when you disarm the Vehicle Security Alarm. Check the vehicle for tampering.

**ILLUMINATED ENTRY**

The interior lights will turn on when you press the UNLOCK button on the Remote Keyless Entry (RKE) transmitter or open a door or the liftgate.

This feature also turns on the approach lighting (if equipped). Refer to “Uconnect Touch™ Settings” in “Understanding Your Instrument Panel” for further information.

The interior lights will fade to off after approximately 30 seconds or they will immediately fade to off once the ignition switch is cycled to ON/RUN.

**NOTE:** *The illuminated entry system will not operate the interior lights if the Dimmer Control is in the extreme downward (Default) position.*

**REMOTE KEYLESS ENTRY (RKE)**

The RKE system allows you to lock or unlock the doors, open the trunk, or activate the Panic Alarm from distances up to approximately 66 ft (20 m) using a handheld Key Fob with RKE transmitter. The RKE transmitter does not need to be pointed at the vehicle to activate the system.

**NOTE:** *Driving at speeds 5 mph (8 km/h) and above disables the system from responding to all RKE transmitter buttons for all RKE transmitters.*

art=021335339.tif NO TRANS



021335339

**Key Fob With RKE Transmitter**

**To Unlock The Doors And Liftgate**

Press and release the UNLOCK button on the RKE transmitter once to unlock the driver's door or twice within five seconds to unlock all doors and liftgate. The turn signal lights will flash to acknowledge the unlock signal. The illuminated entry system will also turn on.

If the vehicle is equipped with Passive Entry, refer to “Keyless Enter-N-Go” under

## THINGS TO KNOW BEFORE STARTING YOUR VEHICLE

"Things To Know Before Starting Your Vehicle" for further information.

### **Remote Key Unlock, Driver Door/All Doors 1st Press**

This feature lets you program the system to unlock either the driver's door or all doors on the first press of the UNLOCK button on the RKE transmitter. To change the current setting, refer to "Uconnect Touch™ Settings" in "Understanding Your Instrument Panel" for further information.

### **Flash Lights With Remote Key Lock**

This feature will cause the turn signal lights to flash when the doors are locked or unlocked with the RKE transmitter. This feature can be turned on or turned off. To change the current setting, refer to "Uconnect Touch™ Settings" in "Understanding Your Instrument Panel" for further information.

### **Turn Headlights On With Remote Key Unlock**

This feature activates the headlights for up to 90 seconds when the doors are unlocked with the RKE transmitter. The time for this feature is programmable on vehicles equipped through Uconnect Touch™. To change the current setting, refer to "Uconnect Touch™ Settings" in "Understanding Your Instrument Panel" for further information.

### **To Lock The Doors And Liftgate**

Press and release the LOCK button on the RKE transmitter to lock all doors and liftgate. The turn signal lights will flash and the horn will chirp to acknowledge the signal.

If the vehicle is equipped with Passive Entry, refer to "Keyless Enter-N-Go" under

"Things To Know Before Starting Your Vehicle" for further information.

### **Sound Horn With Remote Key Lock**

This feature will cause the horn to chirp when the doors are locked with the RKE transmitter. This feature can be turned on or turned off. To change the current setting, refer to "Uconnect Touch™ Settings" in "Understanding Your Instrument Panel" for further information.

### **Remote Open Window Feature**

This feature allows you to remotely lower both front door windows at the same time. To use this feature, press and release the UNLOCK button on the RKE transmitter and then immediately press and hold the UNLOCK button until the windows lower to the level desired or until they lower completely.

---

## THINGS TO KNOW BEFORE STARTING YOUR VEHICLE

### Using The Panic Alarm

To turn the Panic Alarm feature on or off, press and hold the PANIC button on the RKE transmitter for at least one second and release. When the Panic Alarm is on, the headlights and park lights will flash, the horn will pulse on and off, and the interior lights will turn on.

The Panic Alarm will stay on for three minutes unless you turn it off by either pressing the PANIC button a second time or drive the vehicle at a speed of 15 mph (24 km/h) or greater.

#### NOTE:

- *The interior lights will turn off if you cycle the ignition switch to the ACC or ON/RUN position while the Panic Alarm is activated. However, the exterior lights and horn will remain on.*

- *You may need to be less than 35 ft (11 m) from the vehicle when using the RKE transmitter to turn off the Panic Alarm due to the radio frequency noises emitted by the system.*

### Programming Additional Transmitters

Programming Key Fobs or RKE transmitters may be performed at an authorized dealer.

### Transmitter Battery Replacement

The recommended replacement battery is one CR2032 battery.

#### NOTE:

- *Perchlorate Material — special handling may apply. See [www.dtsc.ca.gov/hazardouswaste/perchlorate](http://www.dtsc.ca.gov/hazardouswaste/perchlorate)*

- *Do not touch the battery terminals that are on the back housing or the printed circuit board.*

1. Remove the emergency key by sliding the mechanical latch on the back of the RKE transmitter sideways with your thumb and then pull the key out with your other hand.

2. Insert the tip of the emergency key or a #2 flat blade screwdriver into the slot and gently pry the two halves of the RKE transmitter apart. Make sure not to damage the seal during removal.

**THINGS TO KNOW BEFORE STARTING YOUR VEHICLE**

art=021337430.tif NO TRANS



021337430

3. Remove the battery by turning the back cover over (battery facing downward) and tapping it lightly on a solid surface such as a table or similar, then replace the battery. When replacing the battery, match the + sign on the battery to the + sign on the inside of the battery clip, located on the back cover. Avoid touching the new battery with your fingers. Skin oils may cause battery deterioration. If you touch a battery, clean it with rubbing alcohol.

4. To assemble the RKE transmitter case, snap the two halves together.

**General Information**

This device complies with Part 15 of the FCC rules and RSS 210 of Industry Canada. Operation is subject to the following conditions:

- This device may not cause harmful interference.
- This device must accept any interference received, including interference that may cause undesired operation.

**NOTE:** Changes or modifications not expressly approved by the party responsible for compliance could void the user's authority to operate the equipment.

If your RKE transmitter fails to operate from a normal distance, check for these two conditions:

1. A weak battery in the RKE transmitter. The expected life of the battery is a minimum of three years.
2. Closeness to a radio transmitter such as a radio station tower, airport transmitter, and some mobile or CB radios.

**REMOTE STARTING SYSTEM**

**— IF EQUIPPED**

art=021600481.tif NO TRANS



This system uses the Key Fob Remote Keyless Entry (RKE) transmitter to start the engine conveniently from outside the vehicle while still maintaining security. The system has a range of approximately 300 ft (91 m).

**THINGS TO KNOW BEFORE STARTING YOUR VEHICLE**

**NOTE:**

- *The vehicle must be equipped with an automatic transmission to be equipped with Remote Start.*
- *Obstructions between the vehicle and the Key Fob may reduce this range.*

**How To Use Remote Start**

All of the following conditions must be met before the engine will remote start:

- Shift lever in PARK
- Doors closed
- Hood closed
- Liftgate closed
- HAZARD switch off
- BRAKE switch inactive (brake pedal not pressed)

- Battery at an acceptable charge level
- RKE PANIC button not pressed.
- System not disabled from previous remote start event
- Vehicle theft alarm not active
- Ignition in OFF state

**WARNING!**

- **Do not start or run an engine in a closed garage or confined area. Exhaust gas contains Carbon Monoxide (CO) which is odorless and colorless. Carbon Monoxide is poisonous and can cause serious injury or death when inhaled.**

- **Keep Remote Keyless Entry (RKE) transmitters away from children. Operation of the Remote Start System, windows, door locks or other controls could cause serious injury or death.**

**Remote Start Abort Message On Electronic Vehicle Information Center (EVIC) — If Equipped**

The following messages will display in the EVIC if the vehicle fails to remote start or exits remote start prematurely:

- Remote Start Aborted — Door Ajar
- Remote Start Aborted — Hood Ajar
- Remote Start Aborted — Fuel Low
- Remote Start Aborted — System Fault

## THINGS TO KNOW BEFORE STARTING YOUR VEHICLE

- Remote Start Disabled — Start Vehicle to Reset

The EVIC message stays active until the ignition is cycled to the ON/RUN position.

### To Enter Remote Start Mode

art=021600481.tif NO TRANS



Press and release the REMOTE START button on the RKE transmitter twice, within five seconds. The vehicle doors will lock, parking lights will flash and the horn will chirp twice (if programmed). Then, the engine will start and the vehicle will remain in the Remote Start mode for a 15-minute cycle.

#### NOTE:

- If an engine fault is present or fuel level is low, the vehicle will start and then shutdown in 10 seconds.

- The park lamps will turn on and remain on during Remote Start mode.

- For security, power window and power sunroof operation (if equipped) are disabled when the vehicle is in the Remote Start mode.

- The engine can be started two consecutive times (two 15-minute cycles) with the RKE transmitter. However, the ignition must be cycled to the RUN position before you can repeat the start sequence for a third cycle.

### To Exit Remote Start Mode Without Driving The Vehicle

Press and release the REMOTE START button one time or allow the engine to run for the entire 15 minute cycle.

**NOTE:** To avoid unintentional shutdowns, the system will disable the one time press of the REMOTE START button for two seconds after receiving a valid Remote Start request.

### To Exit Remote Start Mode And Drive The Vehicle

Before the end of 15 minute cycle, press and release the UNLOCK button on the RKE transmitter to unlock the doors and disarm the Vehicle Security Alarm (if equipped). Then, prior to the end of the 15 minute cycle, press and release the START/STOP button.

**NOTE:** The message "Push Start Button" will display in the EVIC until you push the START button.



## THINGS TO KNOW BEFORE STARTING YOUR VEHICLE

### DOOR LOCKS

#### Manual Door Locks

To lock each door, push the door lock knob on each door trim panel downward. To unlock the front doors, pull the inside door handle to the first detent. To unlock the rear doors, pull the door lock knob on the door trim panel upward.

art=021836146.tif NO TRANS

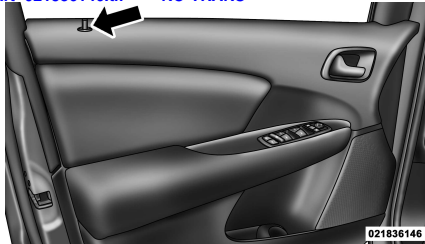

Manual Door Lock Knob

If the door lock knob is down when you shut the door, the door will lock. Therefore, make sure the Key Fob is not inside the vehicle before closing the door.

**NOTE:** *The manual door locks will not lock or unlock the liftgate.*

#### WARNING!

- For personal security and safety in the event of an accident, lock the vehicle doors before you drive as well as when you park and leave the vehicle.

- When leaving the vehicle, always remove the Key Fob from the vehicle and lock your vehicle. Unsupervised use of vehicle equipment may cause severe personal injuries or death.
- Never leave children alone in a vehicle. Leaving unattended children in a vehicle is dangerous for a number of reasons. A child or others could be seriously or fatally injured. Do not leave the Key Fob in the ignition. A child could operate power windows, other controls, or move the vehicle.

#### Power Door Locks

A power door lock switch is on each front door trim panel. Use this switch to lock or unlock the doors and liftgate.

## THINGS TO KNOW BEFORE STARTING YOUR VEHICLE

art=021836147.tif NO TRANS



### Power Door Lock Switch Location

The doors can also be locked and unlocked with the Keyless Enter-N-Go (Passive Entry) system. For further information, refer to “Keyless Enter-N-Go” in “Things To Know Before Starting Your Vehicle”.

If you press the power door lock switch while the Key Fob is in the vehicle, and any front door is open, the power locks will not operate. This prevents you from accidentally locking the Key Fob in the vehicle.

Removing the Key Fob or closing the door will allow the locks to operate. If a door is open, and the ignition is in the LOCK or ACC position, a chime will sound as a reminder to remove the Key Fob.

### Automatic Door Locks

The doors will lock automatically on vehicles with power door locks if the vehicle speed is above 15 mph (24 km/h).

The Auto Door Lock feature can be enabled or disabled by your authorized dealer. See your authorized dealer for service.

**NOTE:** Use the Automatic Door Locks feature in accordance with local laws.

### Automatic Unlock Doors On Exit

The doors will unlock automatically on vehicles with power door locks if:

1. The Automatic Unlock Doors On Exit feature is enabled.
2. The transmission was in gear and the vehicle speed returned to 0 mph (0 km/h).
3. The transmission is in NEUTRAL or PARK.
4. The driver door is opened.
5. The doors were not previously unlocked.
6. The vehicle speed is 0 mph (0 km/h).

To change the current setting, refer to “Uconnect Touch™ Settings” in “Understanding Your Instrument Panel” for further information.

**NOTE:** Use the Automatic Unlock Doors On Exit feature in accordance with local laws.

**THINGS TO KNOW BEFORE STARTING YOUR VEHICLE**

**Child-Protection Door Lock System — Rear Doors**

To provide a safer environment for small children riding in the rear seats, the rear doors are equipped with a Child-Protection Door Lock system.

**To Engage The Child-Protection Door Lock System**

1. Open the rear door.
2. Insert the tip of the emergency key (or alike) into the child lock control and rotate it to the LOCK position.

art=021836148.tif NO TRANS

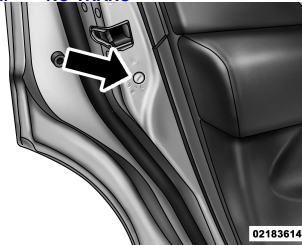

Child-Protection Door Lock Location

art=021836149.tif NO TRANS



Child-Protection Door Lock Function

3. Repeat Steps 1 and 2 for the opposite rear door.

**NOTE:** When the Child-Protection Door Lock system is engaged, the door can be opened only by using the outside door handle even though the inside door lock is in the unlocked position.

**WARNING!**

**Avoid trapping anyone in a vehicle in a collision. Remember that the rear doors can only be opened from the outside when the Child-Protection locks are engaged. Failure to follow this warning may result in serious injury or death.**

**NOTE:**

- After engaging the Child-Protection

## THINGS TO KNOW BEFORE STARTING YOUR VEHICLE

Door Lock system, always test the door from the inside to make certain it is in the desired position.

- For emergency exit with the system engaged, move the lock knob up to the UNLOCK position, roll down the window, and open the door with the outside door handle.

### To Disengage The Child-Protection Door Lock System

1. Open the rear door.
2. Insert the tip of the emergency key (or alike) into the child lock control and rotate it to the UNLOCK position.

art=021836149.tif NO TRANS



### Child-Protection Door Lock Function

3. Repeat Steps 1 and 2 for the opposite rear door.

**NOTE:** After disengaging the Child-Protection Door Lock system, always test the door from the inside to make certain it is in the desired position.

### KEYLESS ENTER-N-GO

The Passive Entry system is an enhancement to the vehicle's Remote Keyless En-

try (RKE) system and a feature of Keyless Enter-N-Go. This feature allows you to lock and unlock the vehicle's door(s) without having to press the RKE transmitter lock or unlock buttons.

### NOTE:

- Passive Entry may be programmed ON/OFF, refer to "Uconnect Touch™ Settings" in "Understanding Your Instrument Panel" for further information.
- If wearing gloves on your hands, or if it has been raining on the passive entry door handle, the unlock sensitivity can be affected, resulting in a slower response time.
- If the vehicle is unlocked by the RKE transmitter or Passive Entry and no door

## THINGS TO KNOW BEFORE STARTING YOUR VEHICLE

goes ajar within 60 seconds, the vehicle will re-lock and if equipped will arm the theft alarm.

### **To Unlock From The Driver's Side:**

With a valid Passive Entry RKE transmitter within 5 ft (1.5 m) of the driver's door handle, grab the driver's front door handle to unlock the driver's door automatically. The interior door panel lock knob will raise when the door is unlocked.

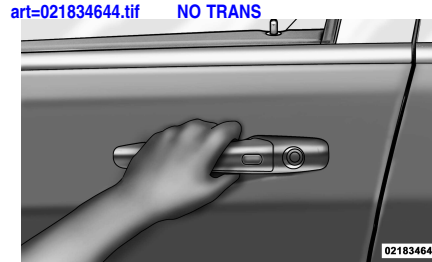

**Grabbing The Driver's Door Handle**

**NOTE:** If "Unlock All Doors 1st Press" is programmed all doors will unlock when you grab hold of the driver's front door handle. To select between "Unlock Driver Door 1st Press" and "Unlock All Doors 1st Press", refer to "Uconnect Touch™ Settings" in "Understanding Your Instrument Panel" for further information.

### **To Unlock From The Passenger Side:**

With a valid Passive Entry RKE transmitter within 5 ft (1.5 m) of the passenger door handle, grab the front passenger door handle to unlock all four doors and the liftgate automatically.

**NOTE:** All doors and the liftgate will unlock when the front passenger door handle is grabbed regardless of the driver's door unlock preference setting ("Unlock Driver Door 1st Press" or "Unlock All Doors 1st Press").

### **To Enter The Liftgate**

With a valid Passive Entry RKE transmitter within 3 ft (1.0 m) of the liftgate, press the button underneath the left side of the accent bar, which is located on the liftgate below the glass, to lock or unlock the vehicle.

## THINGS TO KNOW BEFORE STARTING YOUR VEHICLE

art=022236570.tif NO TRANS



Liftgate Unlock/Lock Button

### ***Preventing Inadvertent Locking Of Passive Entry RKE Transmitter In Vehicle***

To minimize the possibility of unintentionally locking a Passive Entry RKE transmitter inside your vehicle, the Passive Entry system is equipped with an automatic door unlock feature which will function if there is no Key Fob present in the vehicle.

If one of the vehicle doors is open and the door panel switch is used to lock the vehicle, once all open doors have been closed, the vehicle checks the inside and outside of the vehicle for any valid Passive Entry RKE transmitters. If one of the vehicle's Passive Entry RKE transmitters is detected inside the vehicle, and no other valid Passive Entry RKE transmitters is detected outside the vehicle, the Passive Entry System automatically unlocks all vehicle doors and chirps the horn three times (on the third attempt ALL doors will lock and the Passive Entry RKE transmitter can be locked in the vehicle).

### ***To Lock The Vehicle's Doors***

The front door handles have LOCK buttons located on the outside of the handle.

art=021834092.tif NO TRANS

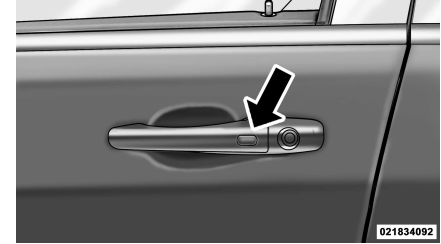

Outside Door Handle Lock Button

With one of the vehicle's Passive Entry RKE transmitters within 5 ft (1.5 m) of the driver or passenger front door handle, press the door handle LOCK button to lock all four doors and the liftgate.

### **NOTE:**

- *After pressing the door handle LOCK button, you must wait two seconds before you can lock or unlock the doors, using either passive entry door handle.*

## THINGS TO KNOW BEFORE STARTING YOUR VEHICLE

This is done to allow you to check if the vehicle is locked by pulling the door handle, without the vehicle reacting and unlocking.

- The passive entry system will not operate if the RKE transmitter battery is dead.

The vehicle doors can also be locked by using the RKE transmitter lock button or the lock button located on the vehicle's interior door panel.

## WINDOWS

### Power Windows

The window controls on the driver's door trim panel control all of the door windows.

art=021936150.tif NO TRANS



Power Window Switches

There are single window controls on each passenger door trim panel, which operate the passenger door windows. The window controls will operate when the ignition is in the ON/RUN or ACC position.

**NOTE:** For vehicles equipped with the Uconnect Touch™, the power window switches will remain active for up to 10 minutes after the ignition switch is cycled to the OFF position. Opening either

front door will cancel this feature. The time is programmable. Refer to "Uconnect Touch™ Settings" in "Understanding Your Instrument Panel" for further information.

### WARNING!

**Never leave children in a vehicle with the Key Fob. Occupants, particularly unattended children, can become entrapped by the windows while operating the power window switches. Such entrapment may result in serious injury or death.**

### Auto-Down Feature

The driver's power window switch has an Auto-down feature. Press the window switch past the first detent, release, and the window will go down automatically.

## THINGS TO KNOW BEFORE STARTING YOUR VEHICLE

To open the window part way, press the window switch to the first detent and release it when you want the window to stop.

To stop the window from going all the way down during the Auto-down operation, pull up on the switch briefly.

### Auto-Up Feature With Anti-Pinch Protection — If Equipped

On some models, the driver's and front passenger's power window switch has an Auto-up feature. Pull the window switch up to the second detent, release, and the window will go up automatically.

To stop the window from going all the way up during the Auto-up operation, push down on the switch briefly.

To close the window part way, pull the window switch up to the first detent and release it when you want the window to stop.

### NOTE:

- *If the window runs into any obstacle during Auto-closure, it will reverse direction and then go back down. Remove the obstacle and use the window switch again to close the window.*
- *Any impact due to rough road conditions may trigger the auto-reverse function unexpectedly during auto-closure. If this happens, pull the switch lightly to the first detent and hold to close window manually.*

### WARNING!

**There is no anti-pinch protection when the window is almost closed. To avoid personal injury, be sure to clear your arms, hands, fingers, and objects from the window path before closing the window. Such entrapment may result in serious injury.**

### Reset

It may be necessary at some point in time to reactivate the Auto-up/Auto-down feature. To do so, perform the following steps:

1. Pull the window switch up to close the window completely and continue to hold the switch up for an additional two seconds after the window is closed.



## THINGS TO KNOW BEFORE STARTING YOUR VEHICLE

2. Push the window switch down firmly to the second detent to open the window completely and continue to hold the switch down for an additional two seconds after the window is fully open.

### Window Lockout Switch

The window lockout switch on the driver's door trim panel allows you to disable the window control on the other doors. To disable the window controls, press and release the window lockout button (setting it in the down position). To enable the window controls, press and release the window lockout button again (setting it in the up position).

art=021936151.tif NO TRANS



Window Lockout Switch

### Wind Buffeting

Wind buffeting can be described as the perception of pressure on the ears or a helicopter-type sound in the ears. Your vehicle may exhibit wind buffeting with the windows down, or the sunroof (if equipped) in certain open or partially open positions. This is a normal occurrence and can be minimized. If the buffeting occurs with the rear windows open,

then open the front and rear windows together to minimize the buffeting. If the buffeting occurs with the sunroof open, adjust the sunroof opening to minimize the buffeting or open any window.

### LIFTGATE

The liftgate can be unlocked or locked with the Remote Keyless Entry (RKE) transmitter, the Keyless Enter-N-Go (Passive Entry) or by activating the power door lock switch located on either front door trim panel.

For further information on Keyless Enter-N-Go (Passive Entry), refer to "Keyless Enter-N-Go" in "Things To Know Before Starting Your Vehicle".

**NOTE:** *The liftgate cannot be unlocked or locked with the manual door lock plungers*

## THINGS TO KNOW BEFORE STARTING YOUR VEHICLE

on the door trim panels or the door lock cylinder on the driver's door.

To open the unlocked liftgate, squeeze the handle and pull the liftgate toward you. Gas props will raise and support the liftgate in the open position.

art=022236320.tif NO TRANS



022236320

Liftgate Release

**NOTE:** Because the gas pressure drops with temperature, it may be necessary to

assist the props when opening the liftgate in cold weather.

### WARNING!

- **Driving with the liftgate open can allow poisonous exhaust gases into your vehicle. These fumes could injure you and your passengers. Keep the liftgate closed when you are operating the vehicle.**
- **If you are required to drive with the liftgate open, make sure that all windows are closed, and the blower switch on the climate control is set at high speed. Do not use the recirculation mode.**

## OCCUPANT RESTRAINTS

Some of the most important safety features in your vehicle are the restraint systems:

- Three-point lap and shoulder belts for all seating positions
- Advanced Front Airbags for driver and front passenger
- Supplemental Active Head Restraints (AHR) located on top of the front seats (integrated into the head restraint)
- Supplemental Driver Side Knee Airbag
- Supplemental Side Airbag Inflatable Curtains (SABIC) that span the front, second, and third row seating for the driver and passengers seated next to a window

**THINGS TO KNOW BEFORE STARTING YOUR VEHICLE**

- Supplemental Seat-Mounted Side Airbags (SAB)
- An energy-absorbing steering column and steering wheel
- Knee bolsters/blockers for front seat occupants
- Front seat belts incorporate pretensioners that may enhance occupant protection by managing occupant energy during an impact event
- All seat belt systems (except the driver's) include Automatic Locking Retractors (ALRs) or a cinching latch plate, or both, which lock the seat belt webbing into position by extending the belt all the way out and then adjusting the belt

to the desired length to restrain a child seat or secure a large item in a seat — if equipped

Please pay close attention to the information in this section. It tells you how to use your restraint system properly, to keep you and your passengers as safe as possible.

If you will be carrying children too small for adult-sized seat belts, the seat belts or the Lower Anchors and Tether for CHildren (LATCH) feature also can be used to hold infant and child restraint systems. For more information on LATCH, refer to Lower Anchors and Tether for CHildren (LATCH).

**NOTE:** *The Advanced Front Airbags have a multistage inflator design. This allows the airbag to have different rates of inflation based on the severity and type of collision.*

Here are some simple steps you can take to minimize the risk of harm from a deploying airbag:

1. **Children 12 years old and under should always ride buckled up in a rear seat.**

**WARNING!**

**Infants in rear facing child restraints should never ride in the front seat of a vehicle with a passenger Advanced Front Airbag. An airbag deployment can cause severe injury or death to infants in that position.**

Children that are not big enough to wear the vehicle seat belt properly (see section on Child Restraints) should be secured in

## THINGS TO KNOW BEFORE STARTING YOUR VEHICLE

the rear seat in child restraints or belt-positioning booster seats. Older children who do not use child restraints or belt-positioning booster seats should ride properly buckled up in the rear seat. Never allow children to slide the shoulder belt behind them or under their arm.

If a child from 1 to 12 years old (not in a rear facing child seat) must ride in the front passenger seat, move the seat as far back as possible and use the proper child restraint. (Refer to "Child Restraints")

You should read the instructions provided with your child restraint to make sure that you are using it properly.

**2. All occupants should always wear their lap and shoulder belts properly.**

**3. The driver and front passenger seats should be moved back as far as practical to allow the Advanced Front Airbags room to inflate.**

**4. Do not lean against the door or window. If your vehicle has side airbags, and deployment occurs, the side airbags will inflate forcefully into the space between you and the door.**

**5. If the airbag system in this vehicle needs to be modified to accommodate a disabled person, contact the Customer Center. Phone numbers are provided under "If You Need Assistance".**

### WARNING!

- Relying on the airbags alone could lead to more severe injuries in a collision. The airbags work with your seat belt to restrain you properly. In some collisions, the airbags won't deploy at all. Always wear your seat belts even though you have airbags.
- Being too close to the steering wheel or instrument panel during Advanced Front Airbag deployment could cause serious injury, including death. Airbags need room to inflate. Sit back, comfortably extending your arms to reach the steering wheel or instrument panel.

## THINGS TO KNOW BEFORE STARTING YOUR VEHICLE

- **Supplemental Side Airbag Inflatable Curtain (SABIC) and Seat-Mounted Side Airbags (SAB) also need room to inflate. Do not lean against the door or window. Sit upright in the center of the seat.**
- **In an accident, you and your passengers can suffer much greater injuries if you are not properly buckled up. You can strike the interior of your vehicle or other passengers, or you can be thrown out of the vehicle. Always be sure you and others in your vehicle are buckled up properly.**

Buckle up even though you are an excellent driver, even on short trips. Someone on the road may be a poor driver and cause an accident that includes you. This

can happen far away from home or on your own street.

Research has shown that seat belts save lives, and they can reduce the seriousness of injuries in an accident. Some of the worst injuries happen when people are thrown from the vehicle. Seat belts reduce the possibility of ejection and the risk of injury caused by striking the inside of the vehicle. Everyone in a motor vehicle should be belted at all times.

### Lap/Shoulder Belts

All seating positions in your vehicle are equipped with combination lap/shoulder belts.

The belt webbing retractor is designed to lock during very sudden stops or impacts. This feature allows the shoulder part of the belt to move freely with you under normal

conditions. However, in an accident, the belt will lock and reduce your risk of striking the inside of the vehicle or being thrown out.

### WARNING!

- **It is dangerous to ride in a cargo area, inside or outside of a vehicle. In an accident, people riding in these areas are more likely to be seriously injured or killed.**
- **Do not allow people to ride in any area of your vehicle that is not equipped with seats and seat belts.**
- **Be sure everyone in your vehicle is in a seat and using a seat belt properly.**

## THINGS TO KNOW BEFORE STARTING YOUR VEHICLE

- Wearing a seat belt incorrectly is dangerous. Seat belts are designed to go around the large bones of your body. These are the strongest parts of your body and can take the forces of an accident best.
- Wearing your belt in the wrong place could make your injuries in an accident much worse. You might suffer internal injuries, or you could even slide out of part of the belt. Follow these instructions to wear your seat belt safely and to keep your passengers safe, too.

- Two people should never be belted into a single seat belt. People belted together can crash into one another in an accident, hurting one another badly. Never use a lap/shoulder belt or a lap belt for more than one person, no matter what their size.

### Lap/Shoulder Belt Operating Instructions

1. Enter the vehicle and close the door. Sit back and adjust the front seat.
2. The seat belt latch plate is located on the pillar near the back of your seat. Grasp the latch plate and pull out the belt. Slide the latch plate up the webbing as far as necessary to make the belt go around your lap.

art=022636141.tif NO TRANS

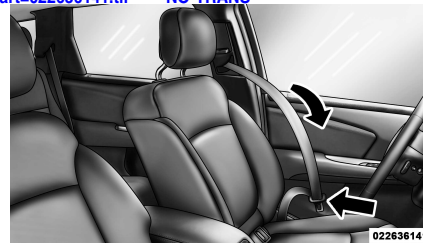

### Pulling Out Lap/Shoulder Belt

3. When the belt is long enough to fit, insert the latch plate into the buckle until you hear a "click."

**THINGS TO KNOW BEFORE STARTING YOUR VEHICLE**

art=022636142.tif NO TRANS



Connecting Latch Plate To Buckle

**WARNING!**

- A belt that is buckled into the wrong buckle will not protect you properly. The lap portion could ride too high on your body, possibly causing internal injuries. Always buckle your belt into the buckle nearest you.

- A belt that is too loose will not protect you properly. In a sudden stop, you could move too far forward, increasing the possibility of injury. Wear your seat belt snugly.
- A belt that is worn under your arm is dangerous. Your body could strike the inside surfaces of the vehicle in an accident, increasing head and neck injury. A belt worn under the arm can cause internal injuries. Ribs aren't as strong as shoulder bones. Wear the belt over your shoulder so that your strongest bones will take the force in a collision.

- A shoulder belt placed behind you will not protect you from injury during an accident. You are more likely to hit your head in a collision if you do not wear your shoulder belt. The lap and shoulder belt are meant to be used together.

4. Position the lap belt across your thighs, below your abdomen. To remove slack in the lap belt portion, pull up a bit on the shoulder belt. To loosen the lap belt if it is too tight, tilt the latch plate and pull on the lap belt. A snug belt reduces the risk of sliding under the belt in an accident.

**THINGS TO KNOW BEFORE STARTING YOUR VEHICLE**

art=022636143.tif NO TRANS



Removing Slack From Belt

**WARNING!**

- **A lap belt worn too high can increase the risk of internal injury in an accident. The belt forces won't be at the strong hip and pelvic bones, but across your abdomen. Always wear the lap belt as low as possible and keep it snug.**

- **A twisted belt will not protect you properly. In a collision, it could even cut into you. Be sure the belt is straight. If you can't straighten a belt in your vehicle, take it to your authorized dealer immediately and have it fixed.**

5. Position the shoulder belt on your chest so that it is comfortable and not resting on your neck. The retractor will withdraw any slack in the belt.

6. To release the belt, push the red button on the buckle. The belt will automatically retract to its stowed position. If necessary, slide the latch plate down the webbing to allow the belt to retract fully.

**WARNING!**

**A frayed or torn belt could rip apart in an accident and leave you with no protection. Inspect the belt system periodically, checking for cuts, frays, or loose parts. Damaged parts must be replaced immediately. Do not disassemble or modify the system. Seat belt assemblies must be replaced after an accident if they have been damaged (bent retractor, torn webbing, etc.).**

**Adjustable Upper Shoulder Belt Anchorage**

In the driver's seat and front passenger's seat, the shoulder belt can be adjusted upward or downward to position the belt



**THINGS TO KNOW BEFORE STARTING YOUR VEHICLE**

away from your neck. Push and fully depress the button above the webbing to release the anchorage, then move it up or down to the position that fits you best.

art=022636144.tif NO TRANS

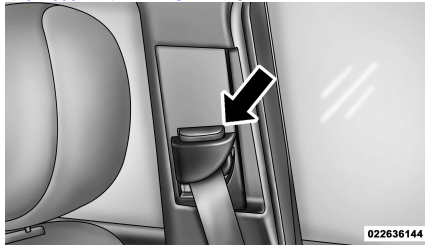

**Adjusting Upper Shoulder Belt**

As a guide, if you are shorter than average you will prefer a lower position and if you are taller than average you will prefer a higher position. When you release the

anchorage try to move it up and down to make sure that it is locked in position.

In the rear seat, move toward the center of the seat to position the belt away from your neck.

**Lap/Shoulder Belt Untwisting Procedure**

Use the following procedure to untwist a twisted lap/shoulder belt.

1. Position the latch plate as close as possible to the anchor point.
2. At about 6 to 12 in (15 to 30 cm) above the latch plate, grasp and twist the belt webbing 180 degrees to create a fold that begins immediately above the latch plate.
3. Slide the latch plate upward over the folded webbing. The folded webbing must enter the slot at the top of the latch plate.

4. Continue to slide the latch plate up until it clears the folded webbing.

**Seat Belts In Passenger Seating Positions**

The seat belts in the passenger seating positions are equipped with Automatic Locking Retractors (ALR) which are used to secure a child restraint system. For additional information refer to "Installing Child Restraints Using The Vehicle Seat Belt" under the "Child Restraints" section. The chart below defines the type of feature for each seating position.

	Driver	Center	Passenger
First Row	N/A	N/A	ALR
Second Row	ALR	ALR	ALR

- N/A — Not Applicable

## THINGS TO KNOW BEFORE STARTING YOUR VEHICLE

- ALR — Automatic Locking Retractor

If the passenger seating position is equipped with an ALR and is being used for normal usage:

Only pull the belt webbing out far enough to comfortably wrap around the occupants mid-section so as to not activate the ALR. If the ALR is activated you will hear a ratcheting sound as the belt retracts. Allow the webbing to retract completely in this case and then carefully pull out only the amount of webbing necessary to comfortably wrap around the occupants mid-section. Slide the latch plate into the buckle until you hear a "click."

### **Automatic Locking Retractor Mode (ALR) — If Equipped**

In this mode, the shoulder belt is automatically pre-locked. The belt will still retract to

remove any slack in the shoulder belt. The Automatic Locking Mode is available on all passenger-seating positions with a combination lap/shoulder belt. Use the Automatic Locking Mode anytime a child safety seat is installed in a seating position that has a belt with this feature. Children 12 years old and under should always be properly restrained in the rear seat.

### **How To Engage The Automatic Locking Mode**

1. Buckle the combination lap and shoulder belt.
2. Grasp the shoulder portion and pull downward until the entire belt is extracted.
3. Allow the belt to retract. As the belt retracts, you will hear a clicking sound.

This indicates the safety belt is now in the Automatic Locking Mode.

### **How To Disengage The Automatic Locking Mode**

Unbuckle the combination lap/shoulder belt and allow it to retract completely to disengage the Automatic Locking Mode and activate the vehicle sensitive (emergency) locking mode.

### **WARNING!**

- **The belt and retractor assembly must be replaced if the seat belt assembly Automatic Locking Retractor (ALR) feature or any other seat belt function is not working properly when checked according to the procedures in the Service Manual.**

**THINGS TO KNOW BEFORE STARTING YOUR VEHICLE**

- **Failure to replace the belt and retractor assembly could increase the risk of injury in collisions.**

**Energy Management Feature**

This vehicle has a safety belt system with an Energy Management feature in the front seating positions to help further reduce the risk of injury in the event of a head-on accident. This safety belt system has a retractor assembly that is designed to release webbing in a controlled manner. This feature is designed to help reduce the belt force acting on the occupant's chest.

**WARNING!**

- **The belt and retractor assembly must be replaced if the seat belt assembly Automatic Locking Retractor (ALR) feature or any other seat belt function is not working properly when checked according to the procedures in the Service Manual.**
- **Failure to replace the belt and retractor assembly could increase the risk of injury in accidents.**

**Seat Belt Pretensioners**

The seat belts for both front seating positions are equipped with pretensioning devices that are designed to remove slack from the seat belt in the event of an accident. These devices may improve the

performance of the seat belt by assuring that the belt is tight about the occupant early in an accident. Pretensioners work for all size occupants, including those in child restraints.

**NOTE:** *These devices are not a substitute for proper seat belt placement by the occupant. The seat belt still must be worn snugly and positioned properly.*

The pretensioners are triggered by the Occupant Restraint Controller (ORC). Like the airbags, the pretensioners are single use items. A deployed pretensioner or a deployed airbag must be replaced immediately.

**Supplemental Active Head Restraints (AHR)**

These head restraints are passive, deployable components, and vehicles with

## THINGS TO KNOW BEFORE STARTING YOUR VEHICLE

this equipment cannot be readily identified by any markings, only through visual inspection of the head restraint. The head restraint will be split in two halves, with the front half being soft foam and trim, the back half being decorative plastic.

### **How the Active Head Restraints (AHR) Work**

The Occupant Restraint Controller (ORC) determines whether the severity, or type of rear impact will require the Active Head Restraints (AHR) to deploy. If a rear impact requires deployment, both the driver and front passenger seat AHRs will be deployed.

When AHRs deploy during a rear impact, the front half of the head restraint extends forward to minimize the gap between the back of the occupant's head and the AHR. This system is designed to help prevent or

reduce the extent of injuries to the driver and front passenger in certain types of rear impacts.

**NOTE:** The Active Head Restraints (AHR) may or may not deploy in the event of a front or side impact. However if during a front impact, a secondary rear impact occurs, the AHR may deploy based on the severity and type of the impact.

art=022607508.tif NO TRANS

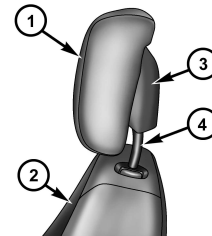

022607508

### **Active Head Restraint (AHR) Components**

- |  |  |
|--|--|
| 1 — Head Restraint Front Half (Soft Foam and Trim) | 3 — Head Restraint Back Half (Decorative Plastic Rear Cover) |
| 2 — Seatback                                       | 4 — Head Restraint Guide Tubes                               |

**THINGS TO KNOW BEFORE STARTING YOUR VEHICLE**

**CAUTION!**  
**All occupants, including the driver, should not operate a vehicle or sit in a vehicle's seat until the head restraints are placed in their proper positions in order to minimize the risk of neck injury in the event of an accident.**

**NOTE:** For more information on properly adjusting and positioning the head restraint, refer to "Adjusting Active Head Restraints" in "Understanding The Features Of Your Vehicle".

**Resetting Active Head Restraints (AHR)**

If the Active Head Restraints are triggered in an accident, you must reset the head

restraint on the driver's and front passenger seat. You can recognize when the Active Head Restraint has been triggered by the fact that they have moved forward (as shown in step three of the resetting procedure).

1. Grasp the deployed AHR from the rear seat.

art=022607492.tif NO TRANS

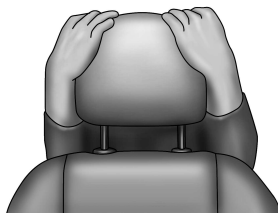

022607492

**Hand Positioning Points On AHR**

2. Position the hands on the top of the deployed AHR at a comfortable position.

3. Pull **down** then **rearward** towards the rear of the vehicle then **down** to engage the locking mechanism.

art=022607497.tif NO TRANS

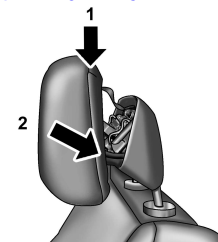

022607497

- 1 — Downward Movement
- 2 — Rearward Movement

**THINGS TO KNOW BEFORE STARTING YOUR VEHICLE**

art=022607757.tif NO TRANS

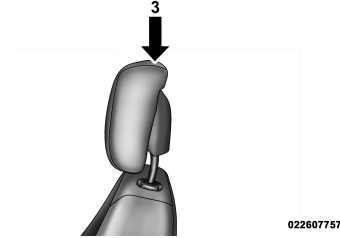

3 — Final Downward Movement To Engage Locking Mechanism

4. The AHR front soft foam and trim half should lock into the back decorative plastic half.

art=022607494.tif NO TRANS

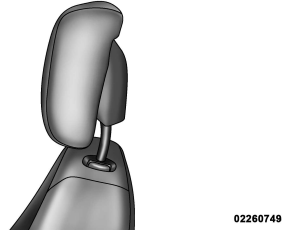

**AHR In Reset Position**

**NOTE:**

- If you have difficulties or problems resetting the Active Head Restraints, see an authorized dealer.
- For safety reasons, have the Active Head Restraints checked by a qualified specialist at an authorized dealer.

**Enhanced Seat Belt Use Reminder System (BeltAlert®)**

BeltAlert® is a feature intended to remind the driver and front passenger (if equipped with front passenger BeltAlert®) to fasten their seatbelts. This feature is active whenever the ignition is on. If the driver or front seat passenger is unbelted, the Seat Belt Reminder Light will turn on and remain on until both front seatbelts are fastened. BeltAlert® triggers within 60 seconds of vehicle speed over 5 mph (8 km/h). The reminder sequence lasts for 96 seconds or until the respective seatbelts are fastened. After the sequence completes, the Seat Belt Reminder Light remains illuminated until front belts are fastened. The driver should instruct all other occupants to fasten their seatbelts. If a front seatbelt is unbuckled while traveling at speeds greater than 5 mph

---

## THINGS TO KNOW BEFORE STARTING YOUR VEHICLE

(8 km/h), BeltAlert® will chime as a single notification and illuminate the Seat Belt Reminder Light, then will proceed to the 96 second reminder sequence.

The front passenger seat BeltAlert® is not active when the front passenger seat is unoccupied. BeltAlert® may be triggered when an animal or heavy object is on the front passenger seat or when the seat is folded flat (if equipped). It is recommended that pets be restrained in the rear seat in pet harnesses or pet carriers that are secured by seat belts, and cargo is properly stowed.

### **BeltAlert® Programming**

**NOTE:** Chrysler Group LLC does not recommend deactivating the BeltAlert®.

The BeltAlert® can be enabled or disabled by your authorized dealer or by performing the following steps:

**NOTE:** The following steps must occur within the first 60 seconds of the ignition being cycled to the ON/RUN position.

1. With all doors closed, and the ignition in any position except ON/RUN, buckle the driver's seat belt.
2. Cycle the ignition to the ON/RUN position, (do not start the engine). Wait for the Seat Belt Reminder Light to turn off and then proceed to the next step.
3. Unbuckle the driver's seat belt, allow the seat belt to retract, and then re-buckle the driver's seat belt at least three times, ending with the seat belt buckled.

**NOTE:** Watch for the Seat Belt Reminder Light to turn on while the seat belt retracts and turn off while re-buckling the seat belt. It may be necessary to completely retract the seat belt each time.

4. Cycle the ignition to the OFF position. A single chime will sound to signify that you have successfully completed the programming.

The BeltAlert® can be reactivated by repeating this procedure.

**NOTE:** When the BeltAlert® is deactivated, the Seat Belt Reminder Light will continue to illuminate as long as the driver's seat belt is unbuckled or retracted.

### **Seat Belts And Pregnant Women**

We recommend that pregnant women use the seat belts throughout their pregnancy.

## THINGS TO KNOW BEFORE STARTING YOUR VEHICLE

Keeping the mother safe is the best way to keep the baby safe.

Pregnant women should wear the lap part of the belt across the thighs and as snug across the hips as possible. Keep the belt low so that it does not come across the abdomen. That way the strong bones of the hips will take the force if there is an accident.

### Seat Belt Extender

If a seat belt is too short even when fully extended and when the adjustable upper shoulder belt anchorage (if equipped) is in its lowest position, your authorized dealer can provide you with a seat belt extender. This extender should be used only if the existing belt is not long enough. When it is not required, remove the extender and store it.

### WARNING!

**Using a seat belt extender when not needed can increase the risk of injury in an accident. Only use when the seat belt is not long enough when it is worn low and snug and in the recommended seating positions. Remove and store the extender when not needed.**

### Supplemental Restraint System (SRS) — Airbags

This vehicle has Advanced Front Airbags for both the driver and front passenger as a supplement to the seat belt restraint systems. The driver's Advanced Front Airbag is mounted in the center of the steering wheel. The passenger's Advanced Front Airbag is mounted in the instrument panel, above the glove compartment. The

words SRS AIRBAG are embossed on the airbag covers. In addition, the vehicle is equipped with a Supplemental Driver Side Knee Airbag mounted in the instrument panel below the steering column.



**THINGS TO KNOW BEFORE STARTING YOUR VEHICLE**

art=022636145.tif NO TRANS

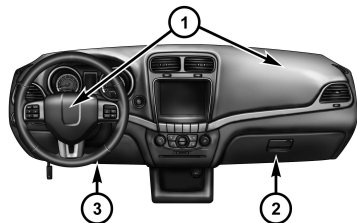

022636145

**Advanced Front Airbag And Knee Bolster Locations**

- 1 — Driver And Passenger Advanced Front Airbags
- 2 — Knee Bolster
- 3 — Supplemental Driver Side Knee Airbag

**NOTE:** These airbags are certified to the new Federal regulations for Advanced Airbags.

The Advanced Front Airbags have a multistage inflator design. This allows the airbag to have different rates of inflation based on the severity and type of collision.

This vehicle may be equipped with driver and/or front passenger seat track position sensors that may adjust the inflation rate of the Advanced Front Airbags based upon seat position.

This vehicle may be equipped with a driver and/or front passenger seat belt buckle switch that detects whether the driver or front passenger seat belt is fastened. The seat belt buckle switch may adjust the inflation rate of the Advanced Front Airbags.

This vehicle is equipped with Supplemental Side Airbag Inflatable Curtains (SABIC) to protect the driver, front, and rear passengers sitting next to a window. The SABIC airbags are located above the side windows and their covers are also labeled: SRS AIRBAG.

This vehicle is equipped with Supplemental Seat-Mounted Side Airbags (SAB). The SABs are marked with an airbag label sewn into the outboard side of the front seats.

**NOTE:**

- Airbag covers may not be obvious in the interior trim; but they will open during airbag deployment.
- After any accident, the vehicle should be taken to an authorized dealer immediately.

## THINGS TO KNOW BEFORE STARTING YOUR VEHICLE

### Airbag System Components

Your vehicle may be equipped with the following airbag system components:

- Occupant Restraint Controller (ORC)
- Airbag Warning Light
- Steering Wheel and Column
- Instrument Panel
- Driver Side Knee Airbag
- Knee Impact Bolster
- Driver Advanced Front Airbag
- Passenger Advanced Front Airbag
- Supplemental Seat-Mounted Side Airbags (SAB)
- Supplemental Side Airbag Inflatable Curtains (SABIC)

- Front and Side Impact Sensors
- Front Seat Belt Pretensioners, Seat Belt Buckle Switch, and Seat Track Position Sensors
- Supplemental Active Head Restraint for Driver and Front Passenger

### Advanced Front Airbag Features

The Advanced Front Airbag system has multistage driver and front passenger airbags. This system provides output appropriate to the severity and type of collision as determined by the Occupant Restraint Controller (ORC), which may receive information from the front impact sensors.

The first stage inflator is triggered immediately during an impact that requires airbag deployment. This low output is used

in less severe collisions. A higher energy output is used for more severe collisions.

### WARNING!

- **No objects should be placed over or near the airbag on the instrument panel, because any such objects could cause harm if the vehicle is in a collision severe enough to cause the airbag to inflate.**

**THINGS TO KNOW BEFORE STARTING YOUR VEHICLE**

- **Do not put anything on or around the airbag covers or attempt to open them manually. You may damage the airbags and you could be injured because the airbags may no longer be functional. The protective covers for the airbag cushions are designed to open only when the airbags are inflating.**
- **Do not drill, cut or tamper with the knee bolster in any way.**
- **Do not mount any accessories to the knee bolster such as alarm lights, stereos, citizen band radios, etc.**

**Supplemental Seat-Mounted Side Airbags (SAB)**

Supplemental Seat-Mounted Side Airbags may provide enhanced protection to help protect an occupant during a side impact. The Supplemental Seat-Mounted Side Airbag is marked with an airbag label sewn into the outboard side of the front seats.

art=022637728.tif NO TRANS

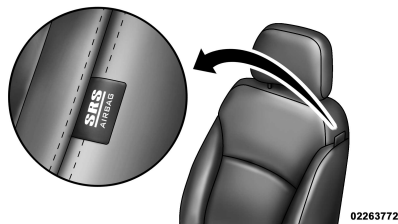

Seat Mounted Side Airbag Label

When the airbag deploys, it opens the seam between the front and side of the seat's trim cover. Each airbag deploys independently, that is a left side impact deploys the left airbag only and a right-side impact deploys only the right airbag.

**Supplemental Side Airbag Inflatable Curtain (SABIC)**

SABIC airbags may offer side-impact and vehicle rollover protection to front and rear seat outboard occupants in addition to that provided by the body structure. Each airbag features inflated chambers placed adjacent to the head of each outboard occupant that reduce the potential for side-impact head injuries. The curtains deploy downward, covering both windows on the impact side.

## THINGS TO KNOW BEFORE STARTING YOUR VEHICLE

art=022607261.tif NO TRANS

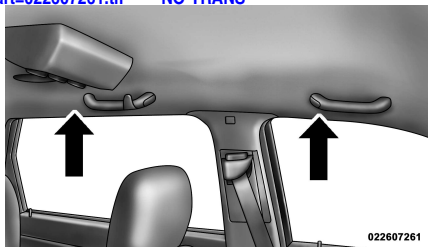

Supplemental Side Airbag Inflatable Curtain  
Location

### NOTE:

- Should a vehicle rollover occur, the pretensioners and/or SAB and SABIC airbags on both sides of the vehicle may deploy.
- Airbag covers may not be obvious in the interior trim; but they will open during airbag deployment.

- Being too close to the SAB and SABIC airbags during deployment could cause you to be severely injured or killed.

The system includes side impact sensors adjacent to both front and rear seat occupants that are calibrated to deploy the SAB and SABIC airbags during impacts that require airbag occupant protection.

### WARNING!

- If your vehicle is equipped with left and right Supplemental Side Airbag Inflatable Curtain (SABIC), do not stack luggage or other cargo up high enough to block the location of the SABIC. The area where the SABIC is located should remain free from any obstructions.

- Do not use accessory seat covers or place objects between you and the side airbags; the performance could be adversely affected and/or objects could be pushed into you, causing serious injury.

### Supplemental Driver Side Knee Airbag

The Supplemental Driver Side Knee Airbag provides enhanced protection and works together with the Driver Advanced Front Airbag during a frontal impact.

### Knee Impact Bolsters

The Knee Impact Bolsters help protect the knees of the driver and the front passenger, and position front occupants for the best interaction with the Advanced Front Airbags.

---

## THINGS TO KNOW BEFORE STARTING YOUR VEHICLE

Along with seat belts and pretensioners, Advanced Front Airbags work with the knee bolsters to provide improved protection for the driver and front passenger. Side airbags also work with seat belts to improve occupant protection.

### **Airbag Deployment Sensors And Controls**

#### **Occupant Restraint Controller (ORC)**

The **ORC** is part of a Federally regulated safety system required for this vehicle.

The ORC determines if deployment of the front and/or side airbags in a frontal or side collision is required. Based on the impact sensors signals, a central electronic ORC deploys the Advanced Front Airbags, SABIC airbags, Supplemental Seat-Mounted Side Airbags, Supplemental Driver Side Knee Airbag, and front seat

belt pretensioners, as required, depending on the severity and type of impact.

The Advanced Front Airbags and Supplemental Driver Side Knee Airbag are designed to provide additional protection by supplementing the seat belts in certain frontal collisions depending on the severity and type of collision. Advanced Front Airbags are not expected to reduce the risk of injury in rear, side, or rollover collisions.

The Advanced Front Airbags and Supplemental Driver Side Knee Airbag will not deploy in all frontal collisions, including some that may produce substantial vehicle damage — for example, some pole collisions, truck underrides, and angle offset collisions. On the other hand, depending on the type and location of impact, Advanced Front Airbags may deploy in

crashes with little vehicle front-end damage but that produce a severe initial deceleration.

The side airbags will not deploy in all side collisions. Side airbag deployment will depend on the severity and type of collision.

Because airbag sensors measure vehicle deceleration over time, vehicle speed and damage by themselves are not good indicators of whether or not an airbag should have deployed.

Seat belts are necessary for your protection in all accidents, and also are needed to help keep you in position, away from an inflating airbag.

The ORC monitors the readiness of the electronic parts of the airbag system whenever the ignition is in the ON/RUN

**THINGS TO KNOW BEFORE STARTING YOUR VEHICLE**

position. If the ignition is in the OFF position, or in the ACC position, the airbag system is not on and the airbags will not inflate.

The ORC contains a backup power supply system that may deploy the airbags even if the battery loses power or it becomes disconnected prior to deployment.

art=022600741.tif **NO TRANS**



Also, the ORC turns on the Airbag Warning Light in the instrument panel for approximately four to eight seconds for a self-check when the ignition is first turned on. After the self-check, the Airbag Warning Light will turn off. If the ORC detects a malfunction in any part of the system, it turns on the Airbag Warning Light, either momentarily or continuously. A single chime will sound if the light comes on again after initial startup.

It also includes diagnostics that will illuminate the instrument cluster Airbag Warning Light if a malfunction is noted that could affect the airbag system. The diagnostics also record the nature of the malfunction.

**WARNING!**

**Ignoring the Airbag Warning Light in your instrument panel could mean you won't have the airbags to protect you in a collision. If the light does not come on as a bulb check when the ignition is first turned on, stays on after you start the vehicle, or if it comes on as you drive, have an authorized dealer service the airbag system immediately.**

**Driver And Passenger Advanced Front Airbag Inflator Units**

The Driver and Passenger Advanced Front Airbag Inflator Units are located in the center of the steering wheel and the right side of the instrument panel. When the ORC detects a collision requiring the Advanced Front Airbags, it signals the inflator units. A large quantity of non-toxic gas is generated to inflate the Advanced Front Airbags. Different airbag inflation rates are possible, based on the collision type and severity. The steering wheel hub trim cover and the upper right side of the instrument panel separate and fold out of the way as the airbags inflate to their full size. The airbags fully inflate in about 50 to 70 milliseconds. This is about half of the time it takes to blink your eyes. The airbags then quickly deflate while helping to restrain the driver and front passenger.

---

**THINGS TO KNOW BEFORE STARTING YOUR VEHICLE**

The Advanced Front Airbag gas is vented through the vent holes in the sides of the airbag. In this way, the airbags do not interfere with your control of the vehicle.

**Supplemental Driver Side Knee Airbag Inflator Unit**

The Supplemental Driver Side Knee Airbag unit is located in the instrument panel trim beneath the steering column. When the ORC detects a collision requiring the airbag, it signals the inflator units. A large quantity of non-toxic gas is generated to inflate the Supplemental Driver Side Knee Airbag. The trim cover separates and folds out of the way allowing the airbag to inflate to the full size. The airbag fully inflates in about 15 to 20 milliseconds. The Supplemental Driver Side Knee Airbag gas is vented through small vent holes in the side of airbag.

**Supplemental Seat-Mounted Side Airbag (SAB) Inflator Units**

The Supplemental Seat-Mounted Side Airbags (SAB) are designed to activate only in certain side collisions.

The ORC determines if a side collision requires the side airbags to inflate based on the severity and type of collision.

Based on the severity and type of collision, the side airbag inflator on the crash side of the vehicle may be triggered, releasing a quantity of non-toxic gas. The inflating SAB exits through the seat seam into the space between the occupant and the door. The SAB fully inflates in about 10 milliseconds. The side airbag moves at a very high speed and with such a high force, that it could injure you if you are not seated properly, or if items are positioned

in the area where the side airbag inflates. This especially applies to children.

**Supplemental Side Airbag Inflatable Curtain (SABIC) Inflator Units**

During collisions where the impact is confined to a particular area of the side of the vehicle, the ORC may deploy the SABIC airbags, depending on the severity and type of collision. In these events, the ORC will deploy the SABIC only on the impact side of the vehicle.

A quantity of non-toxic gas is generated to inflate the side curtain airbag. The inflating side curtain airbag pushes the outside edge of the headliner out of the way and covers the window. The airbag inflates in about 30 milliseconds (about one-quarter of the time that it takes to blink your eyes) with enough force to injure you if you are not belted and seated properly, or if items

## THINGS TO KNOW BEFORE STARTING YOUR VEHICLE

are positioned in the area where the side curtain airbag inflates. This especially applies to children. The side curtain airbag is only about 3-1/2 in (9 cm) thick when it is inflated.

Because airbag sensors estimate deceleration over time, vehicle speed and damage are not good indicators of whether or not an airbag should have deployed.

**NOTE:** *In a rollover the pretensioners and/or SAB and SABIC airbags may deploy on both sides of the vehicle.*

### Front And Side Impact Sensors

In front and side impacts, impact sensors can aid the ORC in determining appropriate response to impact events.

### Enhanced Accident Response System

In the event of an impact causing airbag deployment, if the communication network remains intact, and the power remains intact, depending on the nature of the event the ORC will determine whether to have the Enhanced Accident Response System perform the following functions:

- Cut off fuel to the engine.
- Flash hazard lights as long as the battery has power or until the ignition is cycled to off.
- Turn on the interior lights, which remain on as long as the battery has power or until the ignition key is removed.
- Unlock the doors automatically.

### If A Deployment Occurs

The front airbags are designed to deflate immediately after deployment.

**NOTE:** *Front and/or side airbags will not deploy in all collisions. This does not mean something is wrong with the airbag system.*

If you do have a collision which deploys the airbags, any or all of the following may occur:

- The nylon airbag material may sometimes cause abrasions and/or skin reddening to the driver and front passenger as the airbags deploy and unfold. The abrasions are similar to friction rope burns or those you might get sliding along a carpet or gymnasium floor. They are not caused by contact with chemicals. They are not permanent and



**THINGS TO KNOW BEFORE STARTING YOUR VEHICLE**

normally heal quickly. However, if you haven't healed significantly within a few days, or if you have any blistering, see your doctor immediately.

- As the airbags deflate, you may see some smoke-like particles. The particles are a normal by-product of the process that generates the non-toxic gas used for airbag inflation. These airborne particles may irritate the skin, eyes, nose, or throat. If you have skin or eye irritation, rinse the area with cool water. For nose or throat irritation, move to fresh air. If the irritation continues, see your doctor. If these particles settle on your clothing, follow the garment manufacturer's instructions for cleaning.

Do not drive your vehicle after the airbags have deployed. If you are involved in

another collision, the airbags will not be in place to protect you.

**WARNING!**

**Deployed airbags and seat belt pretensioners cannot protect you in another collision. Have the airbags, seat belt pretensioners, and the front seat belt retractor assemblies replaced by an authorized dealer immediately. Also, have the Occupant Restraint Controller (ORC) system serviced as well.**

**Maintaining Your Airbag System**

**WARNING!**

- **Modifications to any part of the airbag system could cause it to fail when you need it. You could be injured if the airbag system is not there to protect you. Do not modify the components or wiring, including adding any kind of badges or stickers to the steering wheel hub trim cover or the upper right side of the instrument panel. Do not modify the front bumper, vehicle body structure, or add aftermarket side steps or running boards.**
- **It is dangerous to try to repair any part of the airbag system yourself. Be sure to tell anyone who works on your vehicle that it has an airbag system.**

## THINGS TO KNOW BEFORE STARTING YOUR VEHICLE

- **Do not attempt to modify any part of your airbag system. The airbag may inflate accidentally or may not function properly if modifications are made. Take your vehicle to an authorized dealer for any airbag system service. If your seat including your trim cover and cushion needs to be serviced in any way (including removal or loosening/tightening of seat attachment bolts), take the vehicle to your authorized dealer. Only manufacturer approved seat accessories may be used. If it is necessary to modify the airbag system for persons with disabilities, contact your authorized dealer.**

### Airbag Warning Light



art=040408203.tif

NO TRANS

You will want to have the airbags ready to inflate for your protection in a collision. The Airbag Warning Light monitors the internal circuits and inter-connecting wiring associated with airbag system electrical components. While the airbag system is designed to be maintenance free, if any of the following occurs, have an authorized dealer service the airbag system immediately.

- The Airbag Warning Light does not come on during the four to eight seconds when the ignition is first cycled to the ON/RUN position.
- The Airbag Warning Light remains on after the four to eight-second interval.

- The Airbag Warning Light comes on intermittently or remains on while driving.

**NOTE:** *If the speedometer, tachometer, or any engine related gauges are not working, the Occupant Restraint Controller (ORC) may also be disabled. The airbags may not be ready to inflate for your protection. Promptly check the fuse block for blown fuses. Refer to the label located on the inside of the fuse block cover for the proper airbag fuses. See your authorized dealer if the fuse is good.*

### Event Data Recorder (EDR)

This vehicle is equipped with an event data recorder (EDR). The main purpose of an EDR is to record, in certain crash or near crash-like situations, such as an air bag deployment or hitting a road obstacle, data that will assist in understanding how

---

## THINGS TO KNOW BEFORE STARTING YOUR VEHICLE

a vehicle's systems performed. The EDR is designed to record data related to vehicle dynamics and safety systems for a short period of time, typically 30 seconds or less. The EDR in this vehicle is designed to record such data as:

- How various systems in your vehicle were operating;
- Whether or not the driver and passenger safety belts were buckled/fastened;
- How far (if at all) the driver was depressing the accelerator and/or brake pedal; and,
- How fast the vehicle was traveling.

These data can help provide a better understanding of the circumstances in which crashes and injuries occur.

**NOTE:** *EDR data are recorded by your vehicle only if a non-trivial crash situation occurs; no data are recorded by the EDR under normal driving conditions and no personal data (e.g. name, gender, age, and crash location) are recorded. However, other parties, such as law enforcement, could combine the EDR data with the type of personally identifying data routinely acquired during a crash investigation.*

To read data recorded by an EDR, special equipment is required, and access to the vehicle or the EDR is needed. In addition to the vehicle manufacturer, other parties such as law enforcement, that have the special equipment, can read the information if they have access to the vehicle or the EDR.

### **Child Restraints**

Everyone in your vehicle needs to be buckled up all the time, including babies and children. Every state in the United States and all Canadian provinces require that small children ride in proper restraint systems. This is the law, and you can be prosecuted for ignoring it.

Children 12 years and younger should ride properly buckled up in a rear seat, if available. According to crash statistics, children are safer when properly restrained in the rear seats rather than in the front.

## THINGS TO KNOW BEFORE STARTING YOUR VEHICLE

### WARNING!

**In a collision, an unrestrained child, even a tiny baby, can become a projectile inside the vehicle. The force required to hold even an infant on your lap could become so great that you could not hold the child, no matter how strong you are. The child and others could be badly injured. Any child riding in your vehicle should be in a proper restraint for the child's size.**

There are different sizes and types of restraints for children from newborn size to the child almost large enough for an adult safety belt. Always check the child seat Owner's Manual to ensure you have the

correct seat for your child. Use the restraint that is correct for your child.

### Infants And Child Restraints

- Safety experts recommend that children ride rearward-facing in the vehicle until they are at least one year old and weigh at least 20 lbs (9 kg). Two types of child restraints can be used rearward-facing, infant carriers and convertible child seats.
- The infant carrier is only used rearward-facing in the vehicle. It is recommended for children who weigh up to about 20 lbs (9 kg). Convertible child seats can be used either rearward-facing or forward-facing in the vehicle. Convertible child seats often have a higher weight limit in the rearward-facing direction than infant carriers do, so they

can be used rearward-facing by children who weigh more than 20 lbs (9 kg) but are less than one year old. Both types of child restraints are held in the vehicle by the lap/shoulder belt or the LATCH child restraint anchor system. Refer to "Lower Anchors and Tether for Children (LATCH)".

### WARNING!

**Rearward-facing child seats must never be used in the front seat of a vehicle with the front passenger airbag unless the airbag is turned off. An airbag deployment could cause severe injury or death to infants in this position.**

## THINGS TO KNOW BEFORE STARTING YOUR VEHICLE

### Older Children And Child Restraints

Children who weigh more than 20 lbs (9 kg) and who are older than one year can ride forward-facing in the vehicle. Forward-facing child seats and convertible child seats used in the forward-facing direction are for children who weigh 20 to 40 lbs (9 to 18 kg) and who are older than one year. These child seats are also held in the vehicle by the lap/shoulder belt or the LATCH child restraint anchorage system. Refer to "Lower Anchors and Tether for Children (LATCH)".

The belt-positioning booster seat is for children weighing more than 40 lbs (18 kg), but who are still too small to fit the vehicle's seat belts properly. If the child cannot sit with knees bent over the vehicle's seat cushion while the child's back is against the seatback, they should use a

belt-positioning booster seat. The child and belt-positioning booster seat are held in the vehicle by the lap/shoulder belt.

### Integrated Child Booster Seat — If Equipped

The Integrated Child Booster Seat is located in each outboard second-row passenger seat. The Booster Seat is designed for children weighing between 48 and 85 lbs (22 and 39 kg) and between 47 in (119 cm) and 57 in (145 cm) tall.

To position a child into the Integrated Child Booster Seat follow these steps:

1. Slide the second row seat to the full rear position to use the Integrated Child Booster Seat.

**NOTE:** The second row bench with Integrated Child Booster Seat must remain in the full rear position during use.

2. Pull the release loop forward to release the latch and seat cushion.

art=022607262.tif NO TRANS

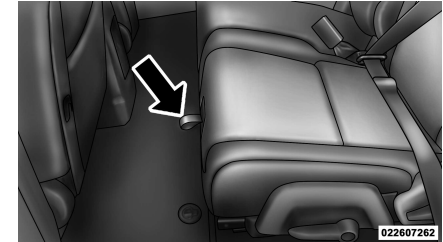

Release Loop

3. Lift the seat cushion up and push back to lock it in the booster seat position.

**THINGS TO KNOW BEFORE STARTING YOUR VEHICLE**

art=022607263.tif NO TRANS

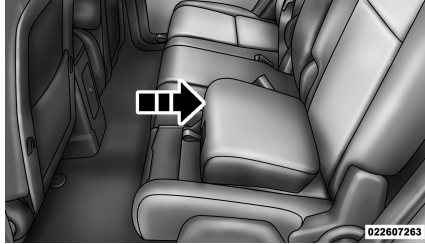

Booster Seat

4. Place the child upright in the seat with their back firmly against the seatback.
5. Grasp the latch plate and pull out the seat belt.
6. Slide the latch plate up the webbing as far as necessary to allow the seat belt to go around the child's lap.

**NOTE:** The lap portion of the seat belt should be low on the hips and as snug as possible.

7. Once the seat belt is long enough to fit properly, insert the latch plate into the buckle until you hear a "click."

art=022606079.tif NO TRANS



8. To remove the slack from the lap belt, pull upward on the shoulder portion of the seat belt.

9. To release the seat belt, push the red button on the buckle.

**WARNING!**

**Be certain that the seat cushion is locked securely into position before using the seat. Otherwise, the seat will not provide the proper stability for child seats and/or passengers. An improperly latched seat cushion could cause serious injury.**

**Children Too Large For Booster Seats**

Children who are large enough to wear the shoulder belt comfortably and whose legs are long enough to bend over the front of the seat when their back is against the seatback should use the lap/shoulder belt in a rear seat.

## THINGS TO KNOW BEFORE STARTING YOUR VEHICLE

- Make sure that the child is upright in the seat.
- The lap portion should be low on the hips and as snug as possible.
- Check belt fit periodically. A child's squirming or slouching can move the belt out of position.
- If the shoulder belt contacts the face or neck, move the child closer to the center of the vehicle. Never allow a child to put the shoulder belt under an arm or behind their back.

**NOTE: For additional information, refer to [www.seatcheck.org](http://www.seatcheck.org) or call 1-866-SEATCHECK. Canadian residents, should refer to Transport Canada's website for additional information.**

<http://www.tc.gc.ca/roadsafety/safedrivers/childsafety/index.htm>

### WARNING!

- **Improper installation can lead to failure of an infant or child restraint. It could come loose in a collision. The child could be badly injured or killed. Follow the manufacturer's directions exactly when installing an infant or child restraint.**
- **A rearward-facing child restraint should only be used in a rear seat. A rearward-facing child restraint in the front seat may be struck by a deploying passenger airbag, which may cause severe or fatal injury to the infant.**

**Here are some tips on getting the most out of your child restraint:**

- Before buying any restraint system, make sure that it has a label certifying that it meets all applicable Safety Standards. Chrysler Group LLC also recommends that you make sure that you can install the child restraint in the vehicle where you will use it before you buy it.
- The restraint must be appropriate for your child's weight and height. Check the label on the restraint for weight and height limits.
- Carefully follow the instructions that come with the restraint. If you install the restraint improperly, it may not work when you need it.

**THINGS TO KNOW BEFORE STARTING YOUR VEHICLE**

- Buckle the child into the seat according to the child restraint manufacturer's directions.

**WARNING!**

**When your child restraint is not in use, secure it in the vehicle with the seat belt or remove it from the vehicle. Do not leave it loose in the vehicle. In a sudden stop or accident, it could strike the occupants or seat-backs and cause serious personal injury.**

**Lower Anchors and Tether for Children (LATCH)**

Your vehicle's second row passenger seats are equipped with the child restraint anchor system called LATCH. The LATCH system provides for the installation of the

child restraint without using the vehicle's seat belts, instead securing the child restraint using lower anchors and upper tether straps from the child restraint to the vehicle structure.

LATCH-compatible child restraint systems are now available. However, because the lower anchors are to be introduced over a period of years, child restraint systems having attachments for those anchors will continue to have features for installation using the vehicle's seat belts. Child restraints having tether straps and hooks for connection to the top tether anchors have been available for some time. For some older child restraints, many child restraint manufacturers offer add-on tether strap kits or retrofit kits. You are urged to take

advantage of all the available attachments provided with your child restraint in any vehicle.

All three second-row passenger seating positions have lower anchors that are capable of accommodating LATCH-compatible child seats. You should never install LATCH-compatible child seats so that two seats share a common lower anchorage. If installing child seats in adjacent seating positions, or if your child restraints are not LATCH-compatible, install the restraints using the vehicle's seat belts.



**THINGS TO KNOW BEFORE STARTING YOUR VEHICLE**

art=022637297.tif NO TRANS

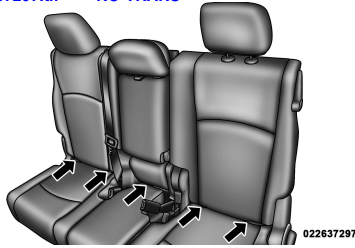

**Latch Anchorages**

**Installing The LATCH-Compatible Child Restraint System**

We urge you to follow the manufacturer's directions carefully when installing your child restraint. Not all child restraint systems will be installed as described here. Again, carefully follow the installation instructions that are provided with the child restraint system.

**NOTE:** When installing a child restraint, if it interferes with the Head Restraint, recline the seatback slightly to remove the interference.

art=022600125.tif NO TRANS



The lower anchors are round bars located at the rear of the seat cushion where it meets the seatback and are just visible when you lean into the rear seat to install the child restraint. You will easily feel them if you run your finger along the intersection of the seatback and seat cushion surfaces.

art=022637297.tif NO TRANS

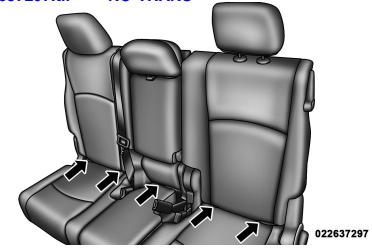

**Latch Anchorages**

In addition, there are tether strap anchors located behind each rear seatback, near to the floor.

## THINGS TO KNOW BEFORE STARTING YOUR VEHICLE

art=022637298.tif NO TRANS

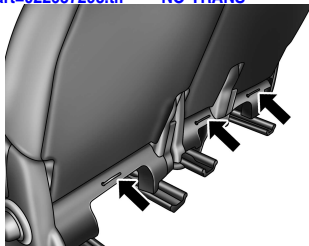

022637298

**Tether Strap Anchors**

Many, but not all restraint systems will be equipped with separate straps on each side, with each having a hook or connector for attachment to the lower anchor and a means of adjusting the tension in the strap. Forward-facing toddler restraints and some rear-facing infant restraints will also be equipped with a tether strap, a hook for attachment to the tether strap

anchor and a means of adjusting the tension of the strap.

You will first loosen the child seat adjusters on the lower straps and on the tether strap so that you can more easily attach the hooks or connectors to the vehicle anchors. Next, attach the lower hooks or connectors over the top of the seatcover material. Then attach the tether strap to the anchor directly behind the seat where you are placing the child restraint, being careful to route the tether strap to provide the most direct path between the anchor and the child restraint, preferably between the head restraint posts underneath the head restraint. For center seating position, adjust the head restraint to the upward position and route the tether strap between the head restraint posts underneath the head restraint. Then, attach the hook

to the tether anchor located on the back of the seat. Finally, tighten all three straps as you push the child restraint rearward and downward into the seat, removing slack in the straps according to the child restraint manufacturer's instructions.

### **NOTE:**

- *Ensure that the tether strap does not slip into the opening between the seat-backs as you remove slack in the strap.*
- *When using the LATCH attaching system to install a child restraint, please ensure that all seat belts not being used for occupant restraints are stowed and out of reach of children. It is recommended that before installing the child restraint, buckle the seat belt so the seat belt is tucked behind the child restraint. This should stow the seat belt out of the reach of an inquisitive child.*

**THINGS TO KNOW BEFORE STARTING YOUR VEHICLE**

*Remind all children in the vehicle that the seat belts are not toys and that they should not play with them. In addition, never leave unattended children in the vehicle.*

**WARNING!**

**Improper installation of a child restraint to the LATCH anchorages can lead to failure of an infant or child restraint. The child could be badly injured or killed. Follow the manufacturer's directions exactly when installing an infant or child restraint.**

**Installing Child Restraints Using The Vehicle Seat Belt**

The seat belts in the passenger seating positions are equipped with an Automatic Locking Retractor (ALR) to secure a Child

Restraint System (CRS). These types of seatbelts are designed to keep the lap portion of the seat belt tight around the child restraint so that it is not necessary to use a locking clip. The ALR will make a ratcheting noise if you extract the entire belt from the retractor and then allow the belt to retract into the retractor. For additional information on ALR, refer to "Automatic Locking Mode". The chart below defines the seating positions with an Automatic Locking Retractor (ALR) or a cinching latch plate.

	Driver	Center	Passenger
	CRS Lock	CRS Lock	CRS Lock
First Row	N/A	N/A	ALR
Second Row	ALR	ALR	ALR

- N/A — Not Applicable
- ALR — Automatic Locking Retractor

Installing a Child Restraint with an ALR:

1. To install a child restraint with ALR, first, pull enough of the seat belt webbing from the retractor to route it through the belt path of the child restraint. Slide the latch plate into the buckle until you hear a "click." Next, extract all the seat belt webbing out of the retractor and then allow the belt to retract into the retractor. As the belt retracts, you will hear a ratcheting sound. This indicates the safety belt is now in the Automatic Locking mode.
2. Finally, pull on any excess webbing to tighten the lap portion around the child restraint. Any seat belt system will loosen

## THINGS TO KNOW BEFORE STARTING YOUR VEHICLE

with time, so check the belt occasionally, and pull it tight if necessary.

**NOTE:** When installing a child restraint, if it interferes with the Head Restraint, recline the seatback slightly to remove the interference.

To attach a child restraint tether strap:

1. Route the tether strap to provide the most direct path for the strap between the anchor and the child seat, preferably between the head restraint posts underneath the head restraint. For center seating position, adjust the head restraint to the upward position and route the tether strap between the head restraint posts underneath the head restraint. Then, attach the hook to the tether anchor located on the back of the seat.

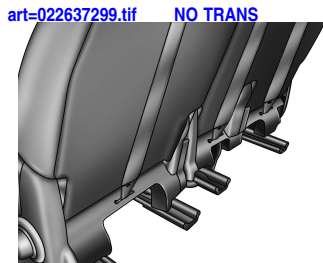

Tether Strap Mounting

2. If necessary, move the seat forward to provide better access to the tether anchor.

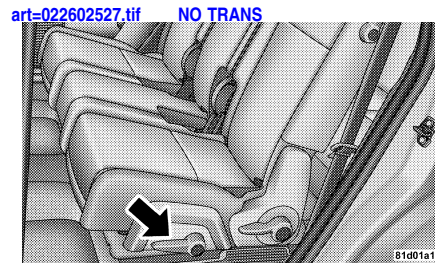

Seat Track Release Lever

3. Attach the tether strap hook of the child restraint to the tether anchor and remove slack in the tether strap according to the child restraint manufacturer's instructions.

**NOTE:** Ensure that the tether strap does not slip into the opening between the seatbacks as you remove slack in the strap.

## THINGS TO KNOW BEFORE STARTING YOUR VEHICLE

### WARNING!

**An incorrectly anchored tether strap could lead to increased head motion and possible injury to the child. Use only the anchor positions directly behind the child seat to secure a child restraint top tether strap.**

### Transporting Pets

Airbags deploying in the front seat could harm your pet. An unrestrained pet will be thrown about and possibly injured, or injure a passenger during panic braking or in an accident.

Pets should be restrained in the rear seat in pet harnesses or pet carriers that are secured by seat belts.

### ENGINE BREAK-IN RECOMMENDATIONS

A long break-in period is not required for the engine and drivetrain (transmission and axle) in your vehicle.

Drive moderately during the first 300 mi (500 km). After the initial 60 mi (100 km), speeds up to 50 or 55 mph (80 or 90 km/h) are desirable.

While cruising, brief full-throttle acceleration, within the limits of local traffic laws, contributes to a good break-in. Wide-open throttle acceleration in low gear can be detrimental and should be avoided.

The engine oil installed in the engine at the factory is a high-quality energy-conserving type lubricant. Oil changes should be consistent with anticipated climate conditions under which vehicle op-

erations will occur. For the recommended viscosity and quality grades refer to "Maintenance Procedures" in "Maintaining Your Vehicle". NON-DETERGENT OR STRAIGHT MINERAL OILS MUST NEVER BE USED.

A new engine may consume some oil during its first few thousand miles (kilometers) of operation. This should be considered a normal part of the break-in and not interpreted as an indication of difficulty.

### SAFETY TIPS

#### Transporting Passengers

NEVER TRANSPORT PASSENGERS IN THE CARGO AREA.

**THINGS TO KNOW BEFORE STARTING YOUR VEHICLE**

**WARNING!**

- Do not leave children or animals inside parked vehicles in hot weather. Interior heat build-up may cause serious injury or death.
- It is extremely dangerous to ride in a cargo area, inside or outside of a vehicle. In a collision, people riding in these areas are more likely to be seriously injured or killed.
- Do not allow people to ride in any area of your vehicle that is not equipped with seats and seat belts.
- Be sure everyone in your vehicle is in a seat and using a seat belt properly.

- On seven passenger models, do not drive the vehicle with the second row passenger seat in the easy entry/exit position (seat cushion flipped upward and seat moved forward), as this position is only intended for entering and exiting the third row seats. Failure to follow this warning may result in personal injury.
- On seven passenger models, do not allow a passenger to sit in a third row seat with the second row seatback(s) folded flat. In a collision, the passenger could slide underneath the seat belt and be seriously or even fatally injured.

**Exhaust Gas**

**WARNING!**

- Exhaust gases can injure or kill. They contain carbon monoxide (CO), which is colorless and odorless. Breathing it can make you unconscious and can eventually poison you. To avoid breathing CO follow these safety tips:

Do not run the engine in a closed garage or in confined areas any longer than needed to move your vehicle in or out of the area.

---

## THINGS TO KNOW BEFORE STARTING YOUR VEHICLE

If it is necessary to sit in a parked vehicle with the engine running, adjust your heating or cooling controls to force outside air into the vehicle. Set the blower at high speed.

If you are required to drive with the liftgate open, make sure that all windows are closed, and the blower switch on the climate control is set at high speed. DO NOT use the recirculation mode.

The best protection against carbon monoxide entry into the vehicle body is a properly maintained engine exhaust system.

Whenever a change is noticed in the sound of the exhaust system, when exhaust fumes can be detected inside the vehicle, or when the underside or rear of the vehicle is damaged, have a compe-

tent mechanic inspect the complete exhaust system and adjacent body areas for broken, damaged, deteriorated, or mispositioned parts. Open seams or loose connections could permit exhaust fumes to seep into the passenger compartment. In addition, inspect the exhaust system each time the vehicle is raised for lubrication or oil change. Replace as required.

### **Safety Checks You Should Make Inside The Vehicle**

#### **Seat Belts**

Inspect the seat belt system periodically, checking for cuts, frays, and loose parts. Damaged parts must be replaced immediately. Do not disassemble or modify the system.

Front seat belt assemblies must be replaced after a collision. Rear seat belt

assemblies must be replaced after a collision if they have been damaged (i.e., bent retractor, torn webbing, etc.). If there is any question regarding belt or retractor condition, replace the seat belt.

#### **Airbag Warning Light**

The light should turn on and remain on for four to six seconds as a bulb check when the ignition switch is first turned ON. If the light is not lit during starting, or if the light stays on, flickers, or turns on while driving, have the system checked by an authorized dealer.

#### **Defroster**

Check operation by selecting the defrost mode and place the blower control on high speed. You should be able to feel the air directed against the windshield. See your authorized dealer for service if your defroster is inoperable.

## THINGS TO KNOW BEFORE STARTING YOUR VEHICLE

### Floor Mat Safety Information

Always use floor mats designed to fit the foot well of your vehicle. Use only floor mats that leave the pedal area unobstructed and that are firmly secured so that they cannot slip out of position and interfere with the pedals or impair safe operation of your vehicle in other ways.

#### WARNING!

**Pedals that cannot move freely can cause loss of vehicle control and increase the risk of serious personal injury.**

- Always make sure that floor mats are properly attached to the floor mat fasteners.

- Never place or install floor mats or other floor coverings in the vehicle that cannot be properly secured to prevent them from moving and interfering with the pedals or the ability to control the vehicle.
- Never put floor mats or other floor coverings on top of already installed floor mats. Additional floor mats and other coverings will reduce the size of the pedal area and interfere with the pedals.
- Check mounting of mats on a regular basis. Always properly re-install and secure floor mats that have been removed for cleaning.

- Always make sure that objects cannot fall into the driver foot well while the vehicle is moving. Objects can become trapped under the brake pedal and accelerator pedal causing a loss of vehicle control.
- If required, mounting posts must be properly installed, if not equipped from the factory.

Failure to properly follow floor mat installation or mounting can cause interference with the brake pedal and accelerator pedal operation causing loss of control of the vehicle.

Periodic Safety Checks You Should Make Outside The Vehicle



---

**THINGS TO KNOW BEFORE STARTING YOUR VEHICLE**

**Tires**

Examine tires for excessive tread wear and uneven wear patterns. Check for stones, nails, glass, or other objects lodged in the tread. Inspect the tread and sidewall for cuts and cracks. Check the wheel nuts for tightness. Check the tires (including spare) for proper pressure.

other fluid leaks. Also, if gasoline fumes are detected or if fuel, power steering fluid, or brake fluid leaks are suspected, the cause should be located and corrected immediately.

**Lights**

Have someone observe the operation of exterior lights while you work the controls. Check Turn Signal and High Beam Indicator Lights on the instrument panel.

**Door Latches**

Check for positive closing, latching, and locking.

**Fluid Leaks**

Check area under vehicle after overnight parking for fuel, engine coolant, oil, or



# SECTION 3

## UNDERSTANDING THE FEATURES OF YOUR VEHICLE

• MIRRORS	75	• UCONNECT TOUCH™ 8.4/8.4 Nav	96
• Inside Day/Night Mirror	75	• Uconnect™ Phone	96
• Automatic Dimming Mirror — If Equipped	75	• Operation	98
• Outside Mirrors	76	• Phone Call Features	106
• Power Mirrors	76	• Uconnect™ Phone Features	110
• Power Folding Mirrors — If Equipped	77	• Advanced Phone Connectivity	113
• Manual Folding Mirrors — If Equipped	77	• Things You Should Know About Your Uconnect™ Phone	114
• Heated Mirrors — If Equipped	77	• General Information	122
• Illuminated Vanity Mirrors — If Equipped	77	• UCONNECT™ VOICE COMMAND 8.4/8.4 Nav	122
• UCONNECT TOUCH™ 4.3	78	• Uconnect™ Voice Command System	
• Uconnect™ Phone	78	• Operation	122
• Operation	80	• Uconnect™ Voice Commands	124
• Phone Call Features	85	• Voice Tree	125
• Uconnect™ Phone Features	89	• SEATS	132
• Advanced Phone Connectivity	92	• Driver's Power Seat — If Equipped	132
• Things You Should Know About Your Uconnect™ Phone	92	• Power Lumbar — If Equipped	133
• General Information	96	• Heated Seats — If Equipped	133

**UNDERSTANDING THE FEATURES OF YOUR VEHICLE**

• Manual Front Seat Adjustments . . . . .	135	• Fog Lights — If Equipped . . . . .	150
• Recliner Adjustment . . . . .	136	• Multifunction Lever . . . . .	151
• Driver's Seat Height Adjustment — If Equipped . . . . .	137	• Turn Signals . . . . .	151
• Fold-Flat Front Passenger Seat — If Equipped . . . . .	137	• Lane Change Assist . . . . .	151
• Head Restraints . . . . .	138	• High/Low Beam Switch . . . . .	151
• Third Row Passenger Seats — Seven Passenger Models . . . . .	140	• Flash-To-Pass . . . . .	152
• 60/40 Split Second-Row Passenger Seats . . . . .	141	• Interior Lights . . . . .	152
• 50/50 Split Third-Row Passenger Seats With Fold-Flat Feature — Seven Passenger Models . . . . .	146	• Map/Reading Lights . . . . .	153
• TO OPEN AND CLOSE THE HOOD . . . . .	147	• WINDSHIELD WIPERS AND WASHERS . . . . .	153
• LIGHTS . . . . .	149	• Intermittent Wiper System . . . . .	153
• Headlight Switch . . . . .	149	• Windshield Wiper Operation . . . . .	154
• Automatic Headlights — If Equipped . . . . .	149	• Windshield Washers . . . . .	155
• Headlights On With Wipers (Available With Automatic Headlights Only) . . . . .	149	• Mist Feature . . . . .	155
• Headlight Time Delay . . . . .	150	• Headlights With Wipers (Available With Automatic Headlights Only) . . . . .	155
• Daytime Running Lights (DRL) — If Equipped . . . . .	150	• TILT/TELESCOPING STEERING COLUMN . . . . .	156
• Lights-On Reminder . . . . .	150	• ELECTRONIC SPEED CONTROL — IF EQUIPPED . . . . .	156
		• To Activate . . . . .	157
		• To Set A Desired Speed . . . . .	157
		• To Deactivate . . . . .	157
		• To Resume Speed . . . . .	158
		• To Vary The Speed Setting . . . . .	158

**UNDERSTANDING THE FEATURES OF YOUR VEHICLE**

• To Accelerate For Passing . . . . .	158	• Using HomeLink® . . . . .	171
• PARKSENSE® REAR PARK ASSIST — IF EQUIPPED . . . . .	159	• Reprogramming A Single HomeLink® Button . . . . .	171
• ParkSense® Sensors . . . . .	159	• Security . . . . .	171
• ParkSense® Warning Display . . . . .	159	• Troubleshooting Tips . . . . .	172
• ParkSense® Display . . . . .	159	• General Information . . . . .	172
• Enabling And Disabling ParkSense® . . . . .	161	• POWER SUNROOF — IF EQUIPPED . . . . .	172
• Service The ParkSense® Rear Park Assist System . . . . .	162	• Opening Sunroof — Express . . . . .	173
• Cleaning The ParkSense® System . . . . .	162	• Sunroof — Manual Mode . . . . .	173
• ParkSense® System Usage Precautions . . . . .	162	• Closing Sunroof — Express . . . . .	174
• PARKVIEW® REAR BACK UP CAMERA — IF EQUIPPED . . . . .	164	• Closing Sunroof — Manual Mode . . . . .	174
• Turning ParkView® On Or Off — With Touch Screen Radio . . . . .	165	• Pinch Protect Feature . . . . .	174
• OVERHEAD CONSOLE . . . . .	166	• Pinch Protect Override . . . . .	174
• Courtesy/Reading Lights . . . . .	166	• Venting Sunroof — Express . . . . .	174
• Sunglasses Storage . . . . .	166	• Sunshade Operation . . . . .	174
• Interior Observation Mirror . . . . .	167	• Wind Buffeting . . . . .	174
• Power Sunroof Switch — If Equipped . . . . .	167	• Sunroof Maintenance . . . . .	175
• GARAGE DOOR OPENER — IF EQUIPPED . . . . .	167	• Ignition Off Operation . . . . .	175
• Programming HomeLink® . . . . .	168	• Sunroof Fully Closed . . . . .	175
• Gate Operator/Canadian Programming . . . . .	171	• ELECTRICAL POWER OUTLETS . . . . .	175
		• POWER INVERTER — IF EQUIPPED . . . . .	178
		• Power Inverter Operation . . . . .	179
		• CUPHOLDERS . . . . .	179
		• STORAGE . . . . .	181

**UNDERSTANDING THE FEATURES OF YOUR VEHICLE**

• Glove Box Storage . . . . .	181	• In-Floor Storage Bin With Removable Liner . .	184
• Floor Console Storage . . . . .	181	• CARGO AREA FEATURES . . . . .	184
• Center Console Storage . . . . .	181	• Rechargeable Flashlight — If Equipped . . . . .	184
• Flip 'n Stow™ Front Passenger Seat Storage — If Equipped . . . . .	182	• Cargo Management System . . . . .	185
• Second-Row Passenger Seat Temporary Storage Bin . . . . .	183	• REAR WINDOW FEATURES . . . . .	188
• Second-Row Map Pocket And Grocery Retainers — If Equipped . . . . .	183	• Rear Window Wiper/Washer . . . . .	188
		• Rear Window Defroster . . . . .	190
		• ROOF LUGGAGE RACK — IF EQUIPPED . . . . .	190

## MIRRORS

art=030407085.tif NO TRANS

art=030436523.tif NO TRANS

### Inside Day/Night Mirror

A single ball joint mirror is provided in the vehicle. It is a twist on mirror that has a fixed position. The mirror installs on the windshield button with a counterclockwise rotation and requires no tools for mounting.

The mirror head can be adjusted up, down, left, and right for various drivers. The mirror should be adjusted to center on the view through the rear window.

Headlight glare from vehicles behind you can be reduced by moving the small control under the mirror to the night position (toward the rear of the vehicle). The mirror should be adjusted while set in the day position (toward the windshield).

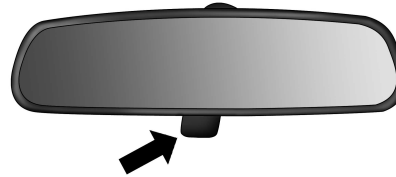

030407085

Manual Rearview Mirror

### Automatic Dimming Mirror — If Equipped

This mirror automatically adjusts for headlight glare from vehicles behind you. This feature will be defaulted on, and only be disabled when the vehicle is moving in reverse.



030436523

Automatic Dimming Mirror

### CAUTION!

To avoid damage to the mirror during cleaning, never spray any cleaning solution directly onto the mirror. Apply the solution onto a clean cloth and wipe the mirror clean.

## UNDERSTANDING THE FEATURES OF YOUR VEHICLE

### Outside Mirrors

To receive maximum benefit, adjust the outside mirror(s) to center on the adjacent lane of traffic and a slight overlap of the view obtained from the inside mirror.

**NOTE:** *The passenger side convex outside mirror will give a much wider view to the rear, and especially of the lane next to your vehicle.*

### WARNING!

**Vehicles and other objects seen in the passenger side convex mirror will look smaller and farther away than they really are. Relying too much on your passenger side convex mirror could cause you to collide with another vehicle or other object. Use your inside mirror when judging the size or distance of a vehicle seen in the passenger side convex mirror. Failure to follow this warning may result in serious injury or death.**

### Power Mirrors

The power mirror switch is located on the driver's door trim panel.

art=030436289.tif NO TRANS



Power Mirror Switches

### **Models Without Express Window Feature**

Press the mirror select button marked L (left) or R (right) and then press one of the four arrow buttons to move the mirror in the direction the arrow is pointing.

### **Models With Express Window Feature**

Press and release the mirror select button marked L (left) or R (right) and then press one of the four arrow buttons to move the



## UNDERSTANDING THE FEATURES OF YOUR VEHICLE

mirror in the direction the arrow is pointing. The selection times out after 30 seconds of inactivity in order to guard against accidentally changing a mirror position following an adjustment.

**NOTE:** A light in the selected button will illuminate indicating the mirror is activated and can be adjusted.

### Power Folding Mirrors — If Equipped

The switch for the power folding mirrors is located between the power mirror switches L (left) and R (right). Press the switch once and the mirrors will fold in, pressing the switch a second time will return the mirrors to the normal driving position.

**NOTE:** Pressing the power folding mirror switch for more than four seconds, or if the

vehicle speed is greater than 5 mph (8 km/h) will disable the folding feature.

If the mirrors are in the folded position, and vehicle speed is equal or greater than 5 mph (8 km/h), they will automatically unfold.

### Manual Folding Mirrors — If Equipped

Some models have exterior mirrors that are hinged. The hinge allows the mirror to pivot forward and rearward to resist damage. The hinge has three detent positions: forward, rearward and normal.

### Heated Mirrors — If Equipped



These mirrors are heated to melt frost or ice. This feature is activated whenever you turn on the rear window defroster. Refer to “Rear Win-

dow Features” in “Understanding The Features Of Your Vehicle” for further information.

### Illuminated Vanity Mirrors — If Equipped

An illuminated vanity mirror is on each sun visor. To use the mirror, rotate the sun visor downward and swing the mirror cover upward. The light will turn on automatically. Closing the mirror cover will turn off the light.

## UNDERSTANDING THE FEATURES OF YOUR VEHICLE

art=030436290.tif NO TRANS

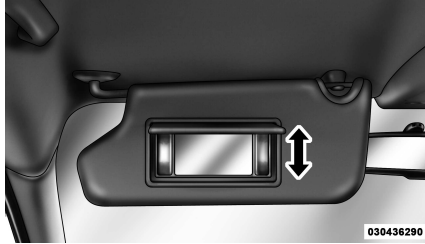

Illuminated Vanity Mirror

### Sun Visor “Slide-On Rod” Feature — If Equipped

This feature allows for additional flexibility in positioning the visor to block out the sun.

1. Fold down the sun visor.
2. Unclip the visor from the center clip.

3. Pull the sun visor toward the inside rearview mirror to extend it.

### UCONNECT TOUCH™ 4.3

#### Uconnect™ Phone

Uconnect™ Phone is a voice-activated, hands-free, in-vehicle communications system. Uconnect™ Phone allows you to dial a phone number with your mobile phone.

Uconnect Phone supports the following features:

#### Voice Activated features:

- Hands Free dialing via Voice (“Call John Smiths Mobile” or, “Dial 248 555-1212”).
- Redialing last dialed numbers (“Redial”).

- Calling Back the last incoming call number (“Call Back”).

- View Call logs on screen (“Show incoming calls”, “Show Outgoing calls”, “Show missed Calls”, “Show Recent Calls”).

- Searching Contacts phone number (“Search for John Smith Mobile”).

#### Screen Activated Features:

- Dialing via Keypad using touch screen.
- Viewing and Calling contacts from Phonebooks displayed on the touch screen.
- Setting Favorite Contact Phone numbers so they are easily accessible on the Main Phone screen.

## UNDERSTANDING THE FEATURES OF YOUR VEHICLE

- Viewing and Calling contacts from Recent Call logs.
  - Listen to Music on your Bluetooth® Device via the touch screen.
  - Pairing up to 10 phones/audio devices for easy access to connect to them quickly.
- For Ram Truck vehicles call 1-866-726-4636
  - [www.chrysler.com/crossbrand/uconnect/chrysler/interface.html](http://www.chrysler.com/crossbrand/uconnect/chrysler/interface.html)
  - [www.chrysler.com/crossbrand/uconnect/dodge/interface.html](http://www.chrysler.com/crossbrand/uconnect/dodge/interface.html)
  - [www.chrysler.com/crossbrand/uconnect/jeep/interface.html](http://www.chrysler.com/crossbrand/uconnect/jeep/interface.html)

Your mobile phone's audio is transmitted through your vehicle's audio system; the system will automatically mute your radio when using the Uconnect™ Phone.

For Uconnect™ customer support call:

- For Chrysler vehicles call 1-800-247-9753
- For Dodge vehicles call 1-800-423-6343
- For Jeep vehicles call 1-877-426-5337

If your mobile phone supports a different profile (e.g., Headset Profile) you may not be able to use any Uconnect™ Phone features. Refer to your mobile service provider or the phone manufacturer for details.

Uconnect™ Phone allows you to transfer calls between the system and your mobile phone as you enter or exit your vehicle and enables you to mute the system's microphone for private conversation.

### WARNING!

**Any voice commanded system should be used only in safe driving conditions following local laws and phone use. All attention should be kept on the roadway ahead. Failure to do so may result in an accident causing serious injury or death.**

The Uconnect™ Phone is driven through your Bluetooth® "Hands-Free Profile" mobile phone. Uconnect™ features

## UNDERSTANDING THE FEATURES OF YOUR VEHICLE

Bluetooth® technology - the global standard that enables different electronic devices to connect to each other without wires or a docking station, so Uconnect™ Phone works no matter where you stow your mobile phone (be it your purse, pocket, or briefcase), as long as your phone is turned on and has been paired to the vehicle's Uconnect™ Phone. The Uconnect™ Phone allows up to ten mobile phones or audio devices to be linked to the system. Only one linked (or paired) mobile phone and one audio device can be used with the system at a time. The system is available in English, Spanish, or French languages.

### Uconnect™ Phone Button

art=010109482.tif



The Uconnect™ Phone Button is used to get into the phone mode and make calls, show recent, incoming, outgoing calls, view phonebook etc., When you press the button you will hear a BEEP. The beep is your signal to give a command.

### Uconnect™ Voice Command Button

art=010109481.tif

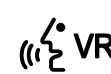

The Uconnect™ Voice Command Button is only used for "barge in" and when you are already in a call and you want to send Tones or make another call.

The Uconnect™ Phone is fully integrated with the vehicle's audio system. The volume of the Uconnect™ Phone can be

adjusted either from the radio volume control knob or from the steering wheel radio control (right switch), if so equipped.

### Operation

Voice commands can be used to operate the Uconnect™ Phone and to navigate through the Uconnect™ Phone menu structure. Voice commands are required after most Uconnect™ Phone prompts. There are two general methods for how Voice Command works:

1. Say compound commands like "Call John Smith mobile".
2. Say the individual commands and allow the system to guide you to complete the task.

---

## UNDERSTANDING THE FEATURES OF YOUR VEHICLE

You will be prompted for a specific command and then guided through the available options.

- Prior to giving a voice command, one must wait for the beep, which follows the "Listen" prompt or another prompt.
- For certain operations, compound commands can be used. For example, instead of saying "Call" and then "John Smith" and then "mobile", the following compound command can be said: "Call John Smith mobile".
- For each feature explanation in this section, only the combined form of the voice command is given. You can also break the commands into parts and say each part of the command when you are asked for it. For example, you can use the combined form voice command

"Search for John Smith", or you can break the combined form command into two voice commands: "Search Contact" and when asked "John Smith". Please remember, the Uconnect™ Phone works best when you talk in a normal conversational tone, as if speaking to someone sitting a few feet/meters away from you.

### Natural Speech

Your Uconnect™ Phone Voice system uses a Natural Language Voice Recognition (VR) engine.

Natural speech allows the user to speak commands in phrases or complete sentences. The system filters out certain non-word utterances and sounds such as "ah" and "eh". The system handles fill-in words such as "I would like to".

The system handles multiple inputs in the same phrase or sentence such as "make a phone call" and "to Kelly Smith". For multiple inputs in the same phrase or sentence, the system identifies the topic or context and provides the associated follow-up prompt such as "Who do you want to call?" in the case where a phone call was requested but the specific name was not recognized.

The system utilizes continuous dialog; when the system requires more information from the user it will ask a question to which the user can respond without pressing the Push-To-Talk (PTT) button.



### Voice Command Tree

Refer to "Voice Tree" in this section.

## UNDERSTANDING THE FEATURES OF YOUR VEHICLE



### Help Command

If you need assistance at any prompt, or if you want to know your options at any prompt, say "Help" following the beep.

To activate the Uconnect™ Phone from idle, simply press the  button and say a command or say "help". All Uconnect™ Phone sessions begin with a press of the  button on the radio control head.

### Cancel Command

At any prompt, after the beep, you can say "Cancel" and you will be returned to the main menu.

You can also press the  or  buttons when the system is listening for a

command and be returned to the main or previous menu.

**NOTE:** Pressing the  or  buttons

while the system is playing is known as "Barging In", refer to "Barge In — Overriding Prompts" for further information.

### Pair (Link) Uconnect™ Phone To A Mobile Phone

To begin using your Uconnect™ Phone, you must pair your compatible Bluetooth® enabled mobile phone.

To complete the pairing process, you will need to reference your mobile phone Owner's Manual. The Uconnect™ website may also provide detailed instructions for pairing.

### NOTE:

- You must have Bluetooth® enabled on your phone to complete this procedure.

- The vehicle must be in Park.

1. Press the Settings hard-key to begin.
2. Press the Phone soft-key.
3. If there is no phone currently paired with the system, a pop-up will appear.
4. Select Yes to begin the pairing process. Then, search for available devices on your Bluetooth® enabled mobile phone. When prompted on the phone, enter the name and PIN shown on the Uconnect™ Touch screen.

- If No is selected, touch the settings soft-key from the Uconnect™ Phone main screen.

---

## UNDERSTANDING THE FEATURES OF YOUR VEHICLE

- Touch the Add Device soft-key.
- Search for available devices on your Bluetooth® enabled mobile phone. When prompted on the phone, enter the name and PIN shown on the Uconnect™ Touch screen.

5. Uconnect™ Phone will display an in process screen while the system is connecting.

6. When the pairing process has successfully completed, the system will prompt you to choose whether or not this is your favorite phone. Selecting Yes will make this phone the highest priority. This phone will take precedence over other paired phones within range.

**NOTE:** For phones which are not made a favorite, the phone priority is determined

*by the order in which it was paired. the latest phone paired will have the higher priority.*

You can also use the following VR commands to bring up the Paired Phones screen from any screen on the radio:

- “Show Paired Phones” or
- “Connect My Phone”

### **Pair A Bluetooth® Streaming Audio Device**

- Touch the Player hard-key to begin.
- Press the Source soft-key.
- Change the Source to Bluetooth®.
- Touch the Add Device soft-key.
- Search for available devices on your Bluetooth® enabled audio device.

When prompted on the device, enter the name and PIN shown on the Uconnect™ Touch screen.

- Uconnect™ Phone will display an in process screen while the system is connecting.

- When the pairing process has successfully completed, the system will prompt you to choose whether or not this is your favorite device. Selecting Yes will make this device the highest priority. This device will take precedence over other paired devices within range.

**NOTE:** *If No is selected, device priority is determined by the order in which it was paired. The latest device paired will have the higher priority.*

## UNDERSTANDING THE FEATURES OF YOUR VEHICLE

You can also use the following VR command to bring up a list of paired audio devices.

- “Show Paired Audio Devices”

### Connecting To A Particular Mobile Phone Or Device

Uconnect™ Phone will automatically connect to the highest priority paired phone within range. If you would need to choose a particular phone or device follow the steps:

- Touch the Settings hard-key.
- Touch the Phone soft-key
- Touch to select the particular phone or device and touch Connect Device.
- Touch the X to exit out of the Settings screen.

### Disconnecting A Device

- Touch the Settings hard-key.
- Touch the Phone soft-key
- Touch to select the device.
- Touch the Disconnect Device soft-key.
- Touch the X to exit out of the Settings screen.

### Deleting A Device

- Touch the Settings hard-key.
- Touch the Phone soft-key
- Touch to select the device.
- Touch the Delete Device soft-key.
- Touch the X to exit out of the Settings screen.

### Making A Phone A Favorite

- Touch the Settings hard-key.
- Touch the Phone soft-key
- Touch to select the device to make a Favorite.

**NOTE:** *You will see the chosen device move to the top of the list.*

- Touch the Make Favorite soft-key.
- Touch the X to exit out of the Settings screen.

### Phonebook Download — Automatic Phonebook Transfer From Mobile Phone

If equipped and specifically supported by your phone, Uconnect™ Phone automatically downloads names (text names) and number entries from the mobile phone's



---

## UNDERSTANDING THE FEATURES OF YOUR VEHICLE

phonebook. Specific Bluetooth® Phones with Phone Book Access Profile may support this feature. See Uconnect™ website for supported phones.

- To call a name from a downloaded mobile phonebook, follow the procedure in “Call by Saying a Name” section.
- Automatic download and update, if supported, begins as soon as the Bluetooth® wireless phone connection is made to the Uconnect™ Phone, for example, after you start the vehicle.
- A maximum of 1000 entries per phone will be downloaded and updated every time a phone is connected to the Uconnect™ Phone.

- Depending on the maximum number of entries downloaded, there may be a short delay before the latest downloaded names can be used. Until then, if available, the previous downloaded phonebook is available for use.
- Only the phonebook of the currently connected mobile phone is accessible.
- This downloaded phonebook cannot be edited or deleted on the Uconnect™ Phone. These can only be edited on the mobile phone. The changes are transferred and updated to Uconnect™ Phone on the next phone connection.

### Emergency And Towing Assistance

The 911/Help numbers can only be altered. These can not be deleted or the names can not be changed.

To change the 911/Help number follow these steps.

- Touch the phonebook soft-key from the Phone main screen.
- Touch the 911/Help soft-key. Touch the appropriate listing to alter, Emergency for example
- Once Emergency is touched, the Edit soft-key appears. Touch the Edit soft-key and you will be given the choice to Edit Number or Reset to Default.
- Follow the on-screen prompts to complete the task.

### Phone Call Features

The following features can be accessed through the Uconnect™ Phone if the feature(s) are available on your mobile service plan. For example, if your mobile

## UNDERSTANDING THE FEATURES OF YOUR VEHICLE

service plan provides three-way calling, this feature can be accessed through the Uconnect™ Phone. Check with your mobile service provider for the features that you have.

### Ways To Initiate A Phone Call

Listed below are all the ways you can initiate a phone call with Uconnect™ Phone.

- Redial
- Dial by touching in the number
- Voice Command Dial (Digital, Contact, Redial, or Call Back)
- Mobile Phonebook
- Recent Call Log

**NOTE:** *All of the above operations except Redial can be done with 1 call or less active.*

### Dial By Saying A Number

- Press the  button to begin.
- After the “Listening” prompt and the following beep, say “Dial 248-555-1212”.
- The Uconnect™ Phone will dial 248-555-1212.

### Call By Saying A Name

- Press the  button to begin.
- After the “Listening” prompt and the following beep, say “Call John Doe Mobile”.

- The Uconnect™ Phone will dial the number associated with John Doe, or if there are multiple numbers it will ask which number you want to call for John Doe.

### Call Controls

The touch-screen allows you to control the following call features:

- Answer
- End
- Ignore
- Hold/unhold
- Mute/unmute
- Transfer the call to/from the phone
- Swap 2 active calls
- Conference/oin 2 active calls together

---

## UNDERSTANDING THE FEATURES OF YOUR VEHICLE

### Touch-Tone Number Entry

- Touch the Phone soft-key.
- Touch the Dial soft-key.
- The Touch-Tone screen will be displayed.
- Use the numbered soft-keys to enter the number and touch Call.

To send a touch tone using Voice Recognition (VR), press the  button while in a call and say "1234#" or you can say "Send Voicemail Password" if Voicemail password is stored in your mobile phone-book.

### Recent Calls

You may browse up to 34 of the most recent of each of the following call types:

- Incoming Calls
- Outgoing Calls
- Missed Calls
- All Calls

These can be accessed by touching the recent calls soft-key on the Phone main screen.

You can also press the  button and say "Show my incoming calls" from any screen and the Incoming calls will be displayed.

**NOTE:** *Incoming can also be replaced with "Outgoing", "Recent" or "Missed".*

### Answer Or Reject An Incoming Call — No Call Currently In Progress

When you receive a call on your mobile phone, the Uconnect™ Phone will inter-

rupt the vehicle audio system, if on, and will display a pop up on-screen showing Answer or Ignore. Press the Answer soft-key or the  button on the steering

wheel to accept the call.

### Answer Or Reject An Incoming Call — Call Currently In Progress

If a call is currently in progress and you have another incoming call, you will hear the same network tones for call waiting that you normally hear when using your mobile phone. Uconnect™ Phone will then interrupt the vehicle audio system, if on, and will display a pop up on-screen showing Answer, Ignore or Transfer. Press the  button to place the current call on hold

and answer the incoming call.

## UNDERSTANDING THE FEATURES OF YOUR VEHICLE

**NOTE:** *The Uconnect™ Phone compatible phones in the market today do not support rejecting an incoming call when another call is in progress. Therefore, the user can only answer an incoming call or ignore it.*

### **Making A Second Call While Current Call Is In Progress**

To make a second call while you are currently on a call, press the  button

and say “Dial” or “Call” followed by the phone number or phonebook entry you wish to call. The first call will be on hold while the second call is in progress. Or you can place a call on hold by touching the Hold soft-key on the Phone main screen, then dial a number from the dial-pad, recent calls or from the phonebooks. To go back to the first call, refer to “Tog-

gling Between Calls” in this section. To combine two calls, refer to “Conference Call” in this section.

### **Toggleing Between Calls**

If two calls are in progress (one active and one on hold), press the  button until

you hear a single beep, indicating that the active and hold status of the two calls have switched. Only one call can be placed on hold at a time. Also you can press the Swap soft-key on the Phone main screen.

### **Call Termination**

To end a call in progress, momentarily press the End soft-key or the  button.

Only the active call(s) will be terminated and if there is a call on hold, it will become the new active call. If the active call is

terminated by the far end, a call on hold may not become active automatically. This is cell phone-dependent.

### **Redial**

- Press the Redial soft-key.
- or press the  button and after the “Listening” prompt and the following beep, say “Redial”.
- After the “Listening” prompt and the following beep, say “Redial”.
- The Uconnect™ Phone will call the last number that was dialed from your mobile phone.

## UNDERSTANDING THE FEATURES OF YOUR VEHICLE

### Call Continuation

Call continuation is the progression of a phone call on the Uconnect™ Phone after the vehicle ignition key has been switched to OFF.

- After the ignition key is switched to OFF, a call can continue on the Uconnect™ Phone either until the call ends, or until the vehicle battery condition dictates cessation of the call on the Uconnect™ Phone and transfer of the call to the mobile phone.

### Uconnect™ Phone Features

#### Emergency Assistance

If you are in an emergency and the mobile phone is reachable:

- Pick up the phone and manually dial the emergency number for your area.

If the phone is not reachable and the Uconnect™ Phone is operational, you may reach the emergency number as follows:

- Press the  button to begin.
- After the “Listening” prompt and the following beep, say “Emergency” and the Uconnect™ Phone will instruct the paired mobile phone to call the emergency number. This feature is supported in the U.S., Canada, and Mexico.

#### NOTE:

- *The emergency number dialed is based on the country where the vehicle is purchased (911 for the U.S. and Canada and 060 for Mexico). The num-*

*ber dialed may not be applicable with the available mobile service and area.*

- *The Uconnect™ Phone does slightly lower your chances of successfully making a phone call as to that for the mobile phone directly.*

### WARNING!

**Your phone must be turned on and paired to the Uconnect™ Phone to allow use of this vehicle feature in emergency situations, when the mobile phone has network coverage and stays paired to the Uconnect™ Phone.**

#### Towing Assistance

If you need towing assistance:

- Press the  button to begin.

## UNDERSTANDING THE FEATURES OF YOUR VEHICLE

- After the “Listening” prompt and the following beep, say “Towing Assistance”.

### NOTE:

- *The towing assistance number dialed is based on the country where the vehicle is purchased (1-800-528-2069 for the U.S., 1-877-213-4525 for Canada, 55-14-3454 for Mexico City and 1-800-712-3040 for outside Mexico City in Mexico). Please refer to the Chrysler Group LLC 24-Hour “Towing Assistance” coverage details in the Warranty Information Booklet and on the 24-Hour Towing Assistance Card.*

### Voice Mail Calling

To learn how to access your voice mail, refer to “Working with Automated Systems”.

### Working With Automated Systems

This method is used in instances where one generally has to press numbers on the mobile phone keypad while navigating through an automated telephone system.

You can use your Uconnect™ Phone to access a voice mail system or an automated service, such as a paging service or automated customer service line. Some services require immediate response selection. In some instances, that may be too quick for use of the Uconnect™ Phone.

When calling a number with your Uconnect™ Phone that normally requires you to enter in a touch-tone sequence on your mobile phone keypad, you can utilize the touch-screen or press the  button and say the word “Send” then the

sequence you wish to enter. For example, if required to enter your PIN followed with a pound, (3 7 4 6 #), you can press the button and say, “Send 3 7 4 6 #”.



Saying “Send” followed by a number, or sequence of numbers, is also to be used for navigating through an automated customer service center menu structure, and to leave a number on a pager.

You can also send stored mobile phonebook entries as tones for fast and easy access to voice mail and pager entries. To use this feature, dial the number you wish to call and then press the 

and say for example, “Send Voicemail password.” The system will prompt you to enter the name or number and say the name of the phonebook entry you wish to send. The Uconnect™ Phone will then

---

## UNDERSTANDING THE FEATURES OF YOUR VEHICLE



send the corresponding phone number associated with the phonebook entry, as tones over the phone.

### NOTE:

- *The first number encountered for that contact will be sent. All other numbers entered for that contact will be ignored.*
- *You may not hear all of the tones due to mobile phone network configurations. This is normal.*
- *Some paging and voice mail systems have system time out settings that are too short and may not allow the use of this feature.*
- *Pauses, wait or other characters that are supported by some phones are not supported over Bluetooth®. These ad-*

*ditional symbols will be ignored in the dialing a numbered sequence.*

### Barge In — Overriding Prompts

The  button can be used when you wish to skip part of a prompt and issue your voice command immediately. For example, if a prompt is asking "There are 2 numbers with the name John. Say the full name" you could press the  button and say, "John Smith" to select that option without having to listen to the rest of the voice prompt.

### Voice Response Length

It is possible for you to choose between Brief and Detailed Voice Response Length.

- Touch the More hard-key, then touch the Settings soft-key.

- Touch the Display soft-key, then scroll down to Voice Response Length.
- Select either Brief or Detailed by touching the box next to the selection. A check-mark will appear to show your selection.

### Phone And Network Status Indicators

Uconnect™ Phone will provide notification to inform you of your phone and network status when you are attempting to make a phone call using Uconnect™ Phone. The status is given for roaming, network signal strength and phone battery strength.

### Dialing Using The Mobile Phone Keypad

You can dial a phone number with your mobile phone keypad and still use the Uconnect™ Phone (while dialing via the

## UNDERSTANDING THE FEATURES OF YOUR VEHICLE

mobile phone keypad, the user must exercise caution and take precautionary safety measures). By dialing a number with your paired Bluetooth® mobile phone, the audio will be played through your vehicle's audio system. The Uconnect™ Phone will work the same as if you dial the number using voice command.

**NOTE:** *Certain brands of mobile phones do not send the dial ring to the Uconnect™ Phone to play it on the vehicle audio system, so you will not hear it. Under this situation, after successfully dialing a number the user may feel that the call did not go through even though the call is in progress. Once your call is answered, you will hear the audio.*

### **Mute/Un-Mute (Mute OFF)**

When you mute the Uconnect™ Phone, you will still be able to hear the conversa-

tion coming from the other party, but the other party will not be able to hear you. In order to mute the Uconnect™ Phone simply touch the Mute button on the Phone main screen.

### **Advanced Phone Connectivity**

#### **Transfer Call To And From Mobile Phone**

The Uconnect™ Phone allows ongoing calls to be transferred from your mobile phone to the Uconnect™ Phone without terminating the call. To transfer an ongoing call from your Uconnect™ Phone paired mobile phone to the Uconnect™ Phone or vice versa, press the Transfer button on the Phone main screen.

#### **Connect Or Disconnect Link Between the Uconnect™ Phone And Mobile Phone**

If you would like to connect or disconnect the Bluetooth® connection between a Uconnect™ Phone paired mobile phone and the Uconnect™ Phone, follow the instructions described in your mobile phone User's Manual.

#### **Things You Should Know About Your Uconnect™ Phone**

##### **Voice Command**

- For best performance, adjust the rear-view mirror to provide at least ½ in (1 cm) gap between the overhead console (if equipped) and the mirror.
- Always wait for the beep before speaking.



---

## UNDERSTANDING THE FEATURES OF YOUR VEHICLE

- Speak normally, without pausing, just as you would speak to a person sitting a few feet/meters away from you.
- Make sure that no one other than you is speaking during a voice command period.
- Performance is maximized under:
  - low-to-medium blower setting,
  - low-to-medium vehicle speed,
  - low road noise,
  - smooth road surface,
  - fully closed windows,
  - dry weather condition.
- Even though the system is designed for users speaking in North American English, French, and Spanish accents, the system may not always work for some.
- When navigating through an automated system such as voice mail, or when sending a page, at the end of speaking the digit string, make sure to say "Send".
- Storing names in your favorites phonebook when the vehicle is not in motion is recommended.
- Phonebook (Downloaded and Uconnect™ Phone Local) name recognition rate is optimized when the entries are not similar.
- You can say "O" (letter "O") for "0" (zero).
- Even though international dialing for most number combinations is supported, some shortcut dialing number combinations may not be supported.
- In a convertible vehicle, system performance may be compromised with the convertible top down.

### Far End Audio Performance

- Audio quality is maximized under:
  - low-to-medium blower setting,
  - low-to-medium vehicle speed,
  - low road noise,
  - smooth road surface,
  - fully closed windows,
  - dry weather conditions, and
  - operation from the driver's seat.

## UNDERSTANDING THE FEATURES OF YOUR VEHICLE

- Performance, such as audio clarity, echo, and loudness to a large degree rely on the phone and network, and not the Uconnect™ Phone.
- Echo at the far end can sometimes be reduced by lowering the in-vehicle audio volume.

- In a convertible vehicle, system performance may be compromised with the convertible top down.

### **Bluetooth® Communication Link**

Mobile phones have been found to lose connection to the Uconnect™ Phone. When this happens, the connection can generally be reestablished by switching

the phone OFF/ON. Your cellular phone is recommended to remain in Bluetooth® ON mode.

### **Power-Up**

After switching the ignition key from OFF to either the ON or ACC position, or after a language change, you must wait at least 15 seconds prior to using the system.

UNDERSTANDING THE FEATURES OF YOUR VEHICLE

Voice Tree

art=030536629.tif TRANSLATE

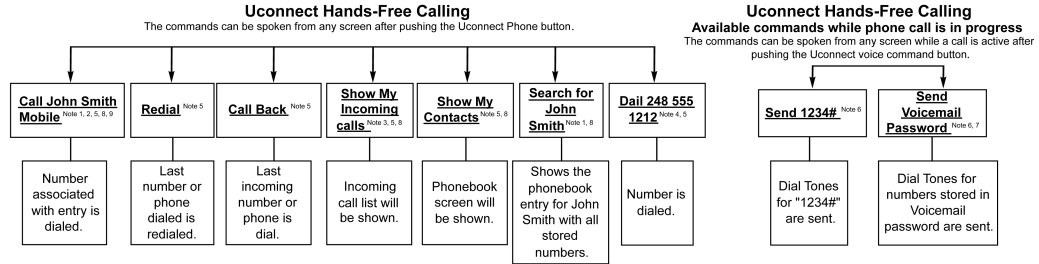

Notes:

- You can replace "John Smith" with any name in your mobile or favorites phonebook. You can also say "**Call John Smith**" and the system will ask you which phone number you want to call for John Smith.
- You can replace "Mobile" with "Home", "Work" or "Other".
- You can replace "Incoming calls" with "outgoing calls", "missed calls" or "all calls".
- You can replace "248 555 1212" with any phone number supported by your Mobile phone.
- These commands can be used during a phone call after pushing the Uconnect voice command button <insert talking head icon> on the steering wheel. Please note the call will be muted while the VR session is active.
- Send dial tones for automated systems is available while a call is active.
- Storing Dial tones in contact names is possible but only the first number encountered in a contact name will be sent. For example if there is a number stored in the Home and Work numbers for the contact Voicemail password only the Home number will be sent.
- If your phone does not support phonebook download or call log download over BT than these commands will return a response indicating that the contact does not exist in the phonebook.
- Emergency and Towing assistance are contacts that have been pre-loaded in the phonebooks. Commands such as "**Call Emergency**" and "**Call towing assistance**" will call the corresponding number stored with those contacts.

Note: Available Voice Commands are shown in bold face and are underlined in the green shaded boxes

030536629

## UNDERSTANDING THE FEATURES OF YOUR VEHICLE

### General Information

This device complies with Part 15 of the FCC rules and RSS 210 of Industry Canada. Operation is subject to the following conditions:

- Changes or modifications not expressly approved by the party responsible for compliance could void the user's authority to operate the equipment.
- This device may not cause harmful interference.
- This device must accept any interference received, including interference that may cause undesired operation.

### UCONNECT TOUCH™ 8.4/8.4 Nav

#### Uconnect™ Phone

Uconnect™ Phone is a voice-activated, hands-free, in-vehicle communications system. Uconnect™ Phone allows you to dial a phone number with your mobile phone.

Uconnect Phone supports the following features:

#### Voice Activated Features:

- Hands Free dialing via Voice ("Call John Smiths Mobile" or, "Dial 248 555-1212").
- Hands Free text to speech listening of your incoming SMS messages.

- Hands Free text messaging ("Send a message to John Smiths Mobile").
- Redialing last dialed numbers ("Redial").
- Calling Back the last incoming call number ("Call Back").
- View Call logs on screen ("Show incoming calls", "Show Outgoing calls", "Show missed Calls", "Show Recent Calls").
- Searching Contacts phone number ("Search for John Smith Mobile").

#### Screen Activated Features:

- Dialing via Keypad using touch screen.
- Viewing and Calling contacts from Phonebooks displayed on the touch screen.

## UNDERSTANDING THE FEATURES OF YOUR VEHICLE

- Setting Favorite Contact Phone numbers so they are easily accessible on the Main Phone screen.
- Viewing and Calling contacts from Recent Call logs.
- Reviewing your recent Incoming SMS.
- Sending a text message via the touch screen.
- Listen to Music on your Bluetooth® Device via the touch screen.
- Pairing up to 10 phones/audio devices for easy access to connect to them quickly.

**NOTE:** *Your phone must be capable of SMS messaging via Bluetooth® for messaging features to work properly.*

Your mobile phone's audio is transmitted through your vehicle's audio system; the system will automatically mute your radio when using the Uconnect™ Phone.

For Uconnect™ customer support call:

- For Chrysler vehicles call 1-800-247-9753
- For Dodge vehicles call 1-800-423-6343
- For Jeep vehicles call 1-877-426-5337
- For Ram Truck vehicles call 1-866-726-4636

For a list of compatible phones see the Uconnect™ websites:

- [www.chrysler.com/crossbrand/uconnect/chrysler/interface.html](http://www.chrysler.com/crossbrand/uconnect/chrysler/interface.html)

- [www.chrysler.com/crossbrand/uconnect/dodge/interface.html](http://www.chrysler.com/crossbrand/uconnect/dodge/interface.html)
- [www.chrysler.com/crossbrand/uconnect/jeep/interface.html](http://www.chrysler.com/crossbrand/uconnect/jeep/interface.html)

Uconnect™ Phone allows you to transfer calls between the system and your mobile phone as you enter or exit your vehicle and enables you to mute the system's microphone for private conversation.

### WARNING!

**Any voice commanded system should be used only in safe driving conditions following local laws and phone use. All attention should be kept on the roadway ahead. Failure to do so may result in an accident causing serious injury or death.**

## UNDERSTANDING THE FEATURES OF YOUR VEHICLE

The Uconnect™ Phone is driven through your Bluetooth® "Hands-Free Profile" mobile phone. Uconnect™ features Bluetooth® technology - the global standard that enables different electronic devices to connect to each other without wires or a docking station, so Uconnect™ Phone works no matter where you stow your mobile phone (be it your purse, pocket, or briefcase), as long as your phone is turned on and has been paired to the vehicle's Uconnect™ Phone. The Uconnect™ Phone allows up to ten mobile phones or audio devices to be linked to the system. Only one linked (or paired) mobile phone and one audio device can be used with the system at a time. The system is available in English, Spanish, or French languages.

### Uconnect™ Phone Button

art=010109482.tif



The Uconnect™ Phone Button is used to get into the phone mode and make calls, show recent, incoming, outgoing calls, view phonebook etc., When you press the button you will hear a BEEP. The beep is your signal to give a command.

### Uconnect™ Voice Command Button

art=010109481.tif

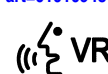

The Uconnect™ Voice Command Button is only used for "bargain in" and when you are already in a call and you want to send Tones or make another call.

The  button is also used to access the Voice Commands for the Uconnect™ Voice Command features if your vehicle is

equipped. Please see the Uconnect™ Voice Command section for direction on how to use the  button.

The Uconnect™ Phone is fully integrated with the vehicle's audio system. The volume of the Uconnect™ Phone can be adjusted either from the radio volume control knob or from the steering wheel radio control (right switch), if so equipped.

### Operation

Voice commands can be used to operate the Uconnect™ Phone and to navigate through the Uconnect™ Phone menu structure. Voice commands are required after most Uconnect™ Phone prompts. There are two general methods for how Voice Command works:

---

## UNDERSTANDING THE FEATURES OF YOUR VEHICLE

1. Say compound commands like “Call John Smith mobile”.

2. Say the individual commands and allow the system to guide you to complete the task.

You will be prompted for a specific command and then guided through the available options.

- Prior to giving a voice command, one must wait for the beep, which follows the “Listen” prompt or another prompt.
- For certain operations, compound commands can be used. For example, instead of saying “Call” and then “John Smith” and then “mobile”, the following compound command can be said: “Call John Smith mobile”.

- For each feature explanation in this section, only the combined form of the voice command is given. You can also break the commands into parts and say each part of the command when you are asked for it. For example, you can use the combined form voice command “Search for John Smith”, or you can break the combined form command into two voice commands: “Search Contact” and when asked “John Smith”. Please remember, the Uconnect™ Phone works best when you talk in a normal conversational tone, as if speaking to someone sitting a few feet/meters away from you.

### Natural Speech

Your Uconnect™ Phone Voice system uses a Natural Language Voice Recognition (VR) engine.

Natural speech allows the user to speak commands in phrases or complete sentences. The system filters out certain non-word utterances and sounds such as “ah” and “eh”. The system handles fill-in words such as “I would like to”.

The system handles multiple inputs in the same phrase or sentence such as “make a phone call” and “to Kelly Smith”. For multiple inputs in the same phrase or sentence, the system identifies the topic or context and provides the associated follow-up prompt such as “Who do you want to call?” in the case where a phone call was requested but the specific name was not recognized.

The system utilizes continuous dialog; when the system requires more information from the user it will ask a question to

## UNDERSTANDING THE FEATURES OF YOUR VEHICLE

which the user can respond without pressing the Push-To-Talk (PTT) button.

### Voice Command Tree

Refer to “Voice Tree” in this section.

### Help Command



If you need assistance at any prompt, or if you want to know your options at any prompt, say “Help” following the beep.

To activate the Uconnect™ Phone from idle, simply press the  button and say

a command or say “help”. All Uconnect™ Phone sessions begin with a press of the  button on the radio control head.

### Cancel Command

At any prompt, after the beep, you can say “Cancel” and you will be returned to the main menu.

You can also press the  or  buttons when the system is listening for a command and be returned to the main or previous menu.

**NOTE:** Pressing the  or  buttons

while the system is playing is known as “Barging In”, refer to “Barge In — Overriding Prompts” for further information.

### Pair (Link) Uconnect™ Phone To A Mobile Phone

To begin using your Uconnect™ Phone, you must pair your compatible Bluetooth® enabled mobile phone.

To complete the pairing process, you will need to reference your mobile phone

Owner’s Manual. The Uconnect™ website may also provide detailed instructions for pairing.

### NOTE:

- You must have Bluetooth® enabled on your phone to complete this procedure.
- The vehicle must be in Park.

1. Press the Phone soft-key on the screen to begin.
2. If there is no phone currently connected with the system, a pop up will appear.



## UNDERSTANDING THE FEATURES OF YOUR VEHICLE



3. Select Yes to begin the pairing process. Then, search for available devices on your Bluetooth® enabled mobile phone. When prompted on the phone, enter the name and PIN shown on the Uconnect Touch™ screen.

- If No is selected, touch the settings soft-key from the Uconnect™ Phone main screen.
- Touch the Add Device soft-key.

- Search for available devices on your Bluetooth® enabled mobile phone. When prompted on the phone, enter the name and PIN shown on the Uconnect Touch™ screen.
- See step 4 to complete the process.

4. Uconnect Phone will display an in process screen while the system is connecting.



5. When the pairing process has successfully completed, the system will prompt you to choose whether or not this is your favorite phone. Selecting Yes will make this phone the highest priority. This phone will take precedence over other paired phones within range.

### Pair Additional Mobile Phones

- Touch the More soft-key to begin.
- Touch the Settings soft-key.
- Next, touch the Phone/Bluetooth® soft-key.
- Touch the Add Device soft-key.
- Search for available devices on your Bluetooth® enabled mobile phone. When prompted on the phone, enter the

## UNDERSTANDING THE FEATURES OF YOUR VEHICLE

name and PIN shown on the Uconnect Touch™ screen.

- Uconnect Phone will display an in-process screen while the system is connecting.
- When the pairing process has successfully completed, the system will prompt you to choose whether or not this is your favorite phone. Selecting Yes will make this phone the highest priority. This phone will take precedence over other paired phones within range.



**NOTE:** For phones which are not made a favorite, the phone priority is determined by the order in which it was paired. The latest phone paired will have the higher priority.

You can also use the following VR commands to bring up the Paired Phone screen from any screen on the radio:

- “Show Paired Phones” or

- “Connect My Phone”

### Pair A Bluetooth® Streaming Audio Device

- Touch the Player soft-key to begin.
- Change the Source to Bluetooth®.
- Touch the Bluetooth® soft-key.
- Touch the Add Device soft-key.

**NOTE:** If there is no device currently connected with the system, a pop up will appear.

- Search for available devices on your Bluetooth® enabled audio device. When prompted on the device, enter the name and PIN shown on the Uconnect Touch™ screen.

---

## UNDERSTANDING THE FEATURES OF YOUR VEHICLE

- Uconnect™ Phone will display an in process screen while the system is connecting.
- When the pairing process has successfully completed, the system will prompt you to choose whether or not this is your favorite device. Selecting Yes will make this device the highest priority. This device will take precedence over other paired devices within range.

**NOTE:** *For devices which are not made a favorite, the device priority is determined by the order in which it was paired. The latest device paired will have the higher priority.*

You can also use the following VR command to bring up a list of paired audio devices.

- “Show Paired Audio Devices”

### **Connecting To A Particular Mobile Phone Or Device**

Uconnect™ Phone will automatically connect to the highest priority paired phone and Bluetooth® audio device within range. If you would need to choose a particular phone or device follow the steps:

- Touch the Phone soft-key.
- Touch the Settings soft-key.
- Touch to select the particular phone or device.
- Touch the X to exit out of the Settings screen.

### **Disconnecting A Device**

- Touch the Phone soft-key.
- Touch the Settings soft-key.
- Touch the + Options soft-key, then touch the + next to the appropriate device to be disconnected.
- The options pop-up will be displayed.
- Touch the Disconnect Device soft-key.
- Touch the X to exit out of the Settings screen.

### **Deleting A Device**

- Touch the Phone soft-key.
- Touch the Settings soft-key.

## UNDERSTANDING THE FEATURES OF YOUR VEHICLE

- Touch the + Options soft-key, then touch the + next to the appropriate device to be disconnected.
- The options pop-up will be displayed.
- Touch the Delete Device soft-key.
- Touch the X to exit out of the Settings screen.

### Making A Phone A Favorite

- Touch the Phone soft-key.
- Touch the Settings soft-key.
- Touch the + Options soft-key, then touch the + next to the appropriate device to be disconnected.
- The options pop-up will be displayed.
- Touch the Make Favorite soft-key.

- You will see the chosen device move to the top of the list.
- Touch the X to exit out of the Settings screen.

### Phonebook Download — Automatic Phonebook Transfer From Mobile Phone

If equipped and specifically supported by your phone, Uconnect™ Phone automatically downloads names (text names) and number entries from the mobile phone's phonebook. Specific Bluetooth® Phones with Phone Book Access Profile may support this feature. See Uconnect™ website for supported phones.

- To call a name from a downloaded mobile phonebook, follow the procedure in "Call by Saying a Name" section.

- Automatic download and update, if supported, begins as soon as the Bluetooth® wireless phone connection is made to the Uconnect™ Phone, for example, after you start the vehicle.
- A maximum of 1000 entries per phone will be downloaded and updated every time a phone is connected to the Uconnect™ Phone.
- Depending on the maximum number of entries downloaded, there may be a short delay before the latest downloaded names can be used. Until then, if available, the previous downloaded phonebook is available for use.
- Only the phonebook of the currently connected mobile phone is accessible.

## UNDERSTANDING THE FEATURES OF YOUR VEHICLE

- This downloaded phonebook cannot be edited or deleted on the Uconnect™ Phone. These can only be edited on the mobile phone. The changes are transferred and updated to Uconnect™ Phone on the next phone connection.

### Managing Your Favorite Phonebook

There are three ways you can add an entry to your Favorite Phonebook.

1. During an active call of a number to make a favorite, touch and hold a favorite button on the top of the phone main screen.
2. After loading the mobile phonebook, select phonebook from the Phone main screen, then select the appropriate number. Touch the + next to the selected number to display the options pop up. In the pop up select Add to Favorites.



**NOTE:** If the Favorites list is full, you will be asked to remove an existing favorite.

3. From the Phone main screen, select phonebook. From the phonebook screen, select favorites and then select the + Options. Select an empty entry and touch the + on that selected entry. When the Options pop up appears, touch Add from mobile. You will then be asked which contact and number to choose from your

mobile phonebook. When complete the new favorite will be shown.

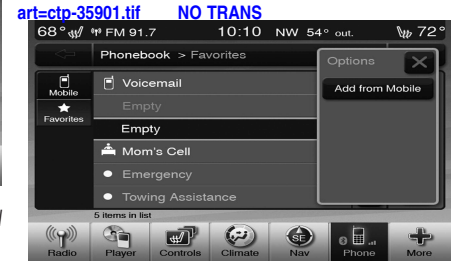

### To Remove A Favorite

- To remove a Favorite, select phonebook from the Phone main screen.
- Next select Favorites on the left side of the screen and then touch the + Options soft-key.

## UNDERSTANDING THE FEATURES OF YOUR VEHICLE

- Touch the + next to the Favorite you would like to remove.

art=ctp-35907.tif NO TRANS



- The Options pop up will display, touch Remove from Favs.

### Emergency And Towing Assistance

The Emergency and Towing Favorite numbers can only be altered. These cannot be deleted and the names cannot be changed.

To change the Emergency or Towing number follow these steps.

- Touch the phonebook soft-key from the Phone main screen.
- Touch the Favorites soft-key. Next scroll to the bottom of the list to locate the Emergency and Towing Favorites.
- Touch the + Options soft-key.
- Touch the + next to appropriate Favorite that is to be altered.

art=ctp-35910.tif NO TRANS

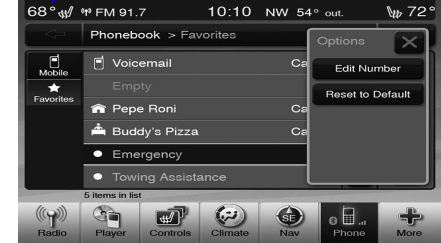

- The Options pop will appear and you can choose between Editing the number or resetting the number to default.

### Phone Call Features

The following features can be accessed through the Uconnect™ Phone if the feature(s) are available and supported by Bluetooth® on your mobile service plan. For example, if your mobile service plan provides three-way calling, this feature can be accessed through the Uconnect™

---

## UNDERSTANDING THE FEATURES OF YOUR VEHICLE

Phone. Check with your mobile service provider for the features that you have.

### Ways To Initiate A Phone Call

Listed below are all the ways you can initiate a phone call with Uconnect™ Phone.

- Redial
- Dial by touching in the number
- Voice Command Dial (Digital, Contact, Redial, or Call Back)
- Favorite Phonebook
- Mobile Phonebook
- Recent Call Log
- SMS Message Viewer

**NOTE:** *All of the above operations except Redial can be done with 1 call or less active.*

### Dial By Saying A Number

- Press the  button to begin.
- After the “Listening” prompt and the following beep, say “Dial 248-555-1212”.
- The Uconnect™ Phone will dial the number 248-555-1212.

### Call By Saying A Name

- Press the  button to begin.
- After the “Listening” prompt and the following beep, say “Call John Doe Mobile”.

- The Uconnect™ Phone will dial the number associated with John Doe, or if there are multiple numbers it will ask which number you want to call for John Doe.

### Call Controls

The touch-screen allows you to control the following call features:

- Answer
- End
- Ignore
- Hold/unhold
- Mute/unmute
- Transfer the call to/from the phone
- Swap 2 active calls
- Conference/join 2 active calls together

## UNDERSTANDING THE FEATURES OF YOUR VEHICLE

### Touch-Tone Number Entry

- Touch the Phone soft-key.
- Touch the Dial soft-key.
- The Touch-Tone screen will be displayed.
- Use the numbered soft-keys to enter the number and touch Call.

To send a touch tone using Voice Recognition (VR), press the  button while in a call and say "Send 1234#" or you can say "Send Voicemail Password" if Voicemail password is stored in your mobile phonebook.

### Recent Calls

You may browse up to 34 of the most recent of each of the following call types:

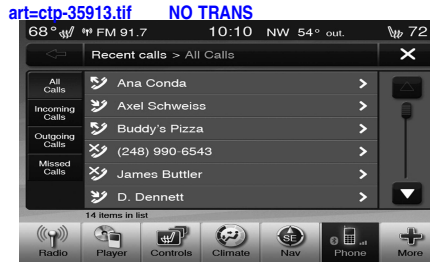

- Incoming Calls
- Outgoing Calls
- Missed Calls
- All Calls

These can be accessed by touching the recent calls soft-key on the Phone main screen.

You can also press the  button and say "Show my incoming calls" from any screen and the Incoming calls will be displayed.

**NOTE:** *Incoming can also be replaced with "Outgoing", "Recent" or "Missed".*

### Answer Or Ignore An Incoming Call — No Call Currently In Progress

When you receive a call on your mobile phone, the Uconnect™ Phone will interrupt the vehicle audio system, if on, and will ask if you would like to answer the call. Press the  button to accept the call. To

ignore the call, touch the "Ignore" soft-key on the touch-screen. You can also touch the answer soft-key or touch the blue caller ID box.



---

## UNDERSTANDING THE FEATURES OF YOUR VEHICLE

### Answer Or Ignore An Incoming Call — Call Currently In Progress

If a call is currently in progress and you have another incoming call, you will hear the same network tones for call waiting that you normally hear when using your mobile phone. Press the phone  button, answer soft-key or caller ID box to place the current call on hold and answer the incoming call.

**NOTE:** *The Uconnect™ Phone compatible phones in the market today do not support rejecting an incoming call when another call is in progress. Therefore, the user can only answer an incoming call or ignore it.*

### Making A Second Call While Current Call Is In Progress

To make a second call while you are currently on a call, press the  button and say “Dial” or “Call” followed by the phone number or phonebook entry you wish to call. The first call will be on hold while the second call is in progress. Or you can place a call on hold by touching the Hold soft-key on the Phone main screen, then dial a number from the dialpad, recent calls, SMS Inbox or from the phonebooks. To go back to the first call, refer to “Toggling Between Calls” in this section. To combine two calls, refer to “Conference Call” in this section.

### Place/Retrieve A Call From Hold

During an active call, touch the Hold soft-key on the Phone main screen.

### Toggling Between Calls

If two calls are in progress (one active and one on hold), touch the Swap soft-key on the Phone main screen. Only one call can be placed on hold at a time.

You can also press the  button to toggle between the active and held phone call.

### Conference Call

When two calls are in progress (one active and one on hold), touch the Conference soft-key on the Phone main screen to combine all calls into a Conference Call.

### Call Termination

To end a call in progress, momentarily press the  button or the end soft-key.

Only the active call(s) will be terminated and if there is a call on hold, it will become

## UNDERSTANDING THE FEATURES OF YOUR VEHICLE

the new active call. If the active call is terminated by the far end, a call on hold may not become active automatically. This is cell phone-dependent.

### Redial

- Press the Redial soft-key.
- or press the  and after the “Listening” prompt and the following beep, say “Redial”.
- After the “Listening” prompt and the following beep, say “Redial”.
- The Uconnect™ Phone will call the last number that was dialed from your mobile phone.

### Call Continuation

Call continuation is the progression of a phone call on the Uconnect™ Phone after the vehicle ignition key has been switched to OFF.

**NOTE:** *the call will remain within the vehicle audio system until the phone becomes out of range for the Bluetooth® connection. It is recommended to press the transfer soft-key when leaving the vehicle.*

### Uconnect™ Phone Features

#### Emergency Assistance

If you are in an emergency and the mobile phone is reachable:

- Pick up the phone and manually dial the emergency number for your area.

If the phone is not reachable and the Uconnect™ Phone is operational, you may reach the emergency number as follows:

- Press the  button to begin.
- After the “Listening” prompt and the following beep, say “Call Emergency or Dial Emergency” and the Uconnect™ Phone will instruct the paired mobile phone to call the emergency number. This feature is supported in the U.S., Canada, and Mexico.

#### NOTE:

- *The Emergency call may also be initiated by touch.*
- *The emergency number dialed is based on the country where the vehicle is purchased (911 for the U.S. and*

## UNDERSTANDING THE FEATURES OF YOUR VEHICLE

Canada and 060 for Mexico). The number dialed may not be applicable with the available mobile service and area.

- The Uconnect™ Phone does slightly lower your chances of successfully making a phone call as to that for the mobile phone directly.

### WARNING!

**Your phone must be turned on and paired to the Uconnect™ Phone to allow use of this vehicle feature in emergency situations, when the mobile phone has network coverage and stays paired to the Uconnect™ Phone.**

### Towing Assistance

If you need towing assistance:

- Press the  button to begin.
- After the “Listening” prompt and the following beep, say “Towing Assistance”.

### NOTE:

- The towing assistance call may also be initiated by touch.
- The towing assistance number dialed is based on the country where the vehicle is purchased (1-800-528-2069 for the U.S., 1-877-213-4525 for Canada, 55-14-3454 for Mexico City and 1-800-712-3040 for outside Mexico City in Mexico). Please refer to the Chrysler Group LLC 24-Hour “Towing Assistance” coverage details in the Warranty Information

Booklet and on the 24-Hour Towing Assistance Card.

### Voice Mail Calling

To learn how to access your voice mail, refer to “Working with Automated Systems”.

### Working With Automated Systems

This method is used in instances where one generally has to press numbers on the mobile phone keypad while navigating through an automated telephone system.

You can use your Uconnect™ Phone to access a voice mail system or an automated service, such as a paging service or automated customer service line. Some services require immediate response selection. In some instances, that may be too quick for use of the Uconnect™ Phone.

## UNDERSTANDING THE FEATURES OF YOUR VEHICLE

When calling a number with your Uconnect™ Phone that normally requires you to enter in a touch-tone sequence on your mobile phone keypad, you can utilize the touch-screen or press the  button

and say the word “Send” then the sequence you wish to enter. For example, if required to enter your PIN followed with a pound, (3 7 4 6 #), you can press the

 button and say, “Send 3 7 4 6 #”. Saying “Send” followed by a number, or sequence of numbers, is also to be used for navigating through an automated customer service center menu structure, and to leave a number on a pager.

You can also send stored mobile phonebook entries as tones for fast and easy access to voice mail and pager entries. To use this feature, dial the number you wish



to call and then press the  button and say for example, “Send Voicemail password.” The system will prompt you to enter the name or number and say the name of the phonebook entry you wish to send. The Uconnect™ Phone will then send the corresponding phone number associated with the phonebook entry, as tones over the phone.

### NOTE:

- *The first number encountered for that contact will be sent. All other numbers entered for that contact will be ignored.*
- *You may not hear all of the tones due to mobile phone network configurations. This is normal.*

- *Some paging and voice mail systems have system time out settings that are too short and may not allow the use of this feature.*
- *Pauses, wait or other characters that are supported by some phones are not supported over Bluetooth®. These additional symbols will be ignored in the dialing a numbered sequence.*

### Barge In — Overriding Prompts

The  button can be used when you wish to skip part of a prompt and issue your voice command immediately. For example, if a prompt is asking “There are 2 numbers with the name John. Say the full name” you could press the  button

---

## UNDERSTANDING THE FEATURES OF YOUR VEHICLE

and say, "John Smith" to select that option without having to listen to the rest of the voice prompt.

### Voice Response Length

It is possible for you to choose between Brief and Detailed Voice Response Length.

- Touch the More soft-key, then touch the Settings soft-key.
- Touch the Display soft-key, then scroll down to Voice Response Length.
- Select either Brief or Detailed by touching the box next to the selection. A check-mark will appear to show your selection.

### Phone And Network Status Indicators

Uconnect™ Phone will provide notification to inform you of your phone and network

status when you are attempting to make a phone call using Uconnect™ Phone. The status is given for network signal strength and phone battery strength.

### Dialing Using The Mobile Phone Keypad

You can dial a phone number with your mobile phone keypad and still use the Uconnect™ Phone (while dialing via the mobile phone keypad, the user must exercise caution and take precautionary safety measures). By dialing a number with your paired Bluetooth® mobile phone, the audio will be played through your vehicle's audio system. The Uconnect™ Phone will work the same as if you dial the number using voice command.

**NOTE:** *Certain brands of mobile phones do not send the dial ring to the Uconnect™ Phone to play it on the vehicle*

*audio system, so you will not hear it. Under this situation, after successfully dialing a number the user may feel that the call did not go through even though the call is in progress. Once your call is answered, you will hear the audio.*

### Mute/Un-Mute (Mute OFF)

When you mute the Uconnect™ Phone, you will still be able to hear the conversation coming from the other party, but the other party will not be able to hear you. In order to mute the Uconnect™ Phone simply touch the Mute button on the Phone main screen.

### Advanced Phone Connectivity

#### Transfer Call To And From Mobile Phone

The Uconnect™ Phone allows ongoing calls to be transferred from your mobile

## UNDERSTANDING THE FEATURES OF YOUR VEHICLE

phone to the Uconnect™ Phone without terminating the call. To transfer an ongoing call from your Uconnect™ Phone paired mobile phone to the Uconnect™ Phone or vice versa, press the Transfer button on the Phone main screen.

### **Connect Or Disconnect Link Between The Uconnect™ Phone And Mobile Phone**

If you would like to connect or disconnect the Bluetooth® connection between a Uconnect™ Phone paired mobile phone and the Uconnect™ Phone, follow the instructions described in your mobile phone User's Manual.

### **Things You Should Know About Your Uconnect™ Phone**

#### **Voice Command**

- For best performance, adjust the rear-view mirror to provide at least 1/2 in (1 cm) gap between the overhead console (if equipped) and the mirror.
- Always wait for the beep before speaking.
- Speak normally, without pausing, just as you would speak to a person sitting a few feet/meters away from you.
- Make sure that no one other than you is speaking during a voice command period.
- Performance is maximized under:
  - low-to-medium blower setting,

- low-to-medium vehicle speed,
- low road noise,
- smooth road surface,
- fully closed windows,
- dry weather condition.
- Even though the system is designed for users speaking in North American English, French, and Spanish accents, the system may not always work for some.
- When navigating through an automated system such as voice mail, or when sending a page, before speaking the digit string, make sure to say "Send".
- Storing names in your favorites phonebook when the vehicle is not in motion is recommended.

## UNDERSTANDING THE FEATURES OF YOUR VEHICLE

- Phonebook (Downloaded and Uconnect™ Phone Local) name recognition rate is optimized when the entries are not similar.
  - You can say “O” (letter “O”) for “0” (zero).
  - Even though international dialing for most number combinations is supported, some shortcut dialing number combinations may not be supported.
  - In a convertible vehicle, system performance may be compromised with the convertible top down.
- Far End Audio Performance**
- Audio quality is maximized under:
    - low-to-medium blower setting,
    - low-to-medium vehicle speed,
    - low road noise,
    - smooth road surface,
    - fully closed windows,
    - dry weather conditions, and
    - operation from the driver’s seat.
  - Performance, such as audio clarity, echo, and loudness to a large degree rely on the phone and network, and not the Uconnect™ Phone.
  - Echo at the far end can sometimes be reduced by lowering the in-vehicle audio volume.
  - In a convertible vehicle, system performance may be compromised with the convertible top down.

### SMS

Uconnect™ Phone can read or send new messages on your phone.

Your phone must support SMS over Bluetooth® in order to use this feature. If the Uconnect™ Phone determines your phone is not compatible with SMS messaging over Bluetooth® the “Messaging” button will be greyed out and the feature will not be available for use.

**NOTE:** *Uconnect™ Phone SMS is only available when the vehicle is not in moving.*

## UNDERSTANDING THE FEATURES OF YOUR VEHICLE

[art=ctp-35983.tif](#) NO TRANS



### Read Messages:

If you receive a new text message while your phone is connected to Uconnect™ Phone, an announcement will be made to notify you that you have a new text message.

[art=ctp-35985.tif](#) NO TRANS



Once a message is received and viewed or listened to, you will have the following options:

- Send a Reply
- Forward
- Call

### Send Messages Using Soft-Keys:

You can send messages using Uconnect™ Phone. To send a new message:

- Touch the Phone soft-key.
- Touch the messaging soft-key then new message.
- Touch one of the 18 preset messages and the person you wish to send the message to.

[art=ctp-35984.tif](#) NO TRANS







**UNDERSTANDING THE FEATURES OF YOUR VEHICLE**

- If multiple numbers are available for the contact select which number you would like to have the message sent.
- Press “Send” or “Cancel”.

**Send Messages Using Voice Commands:**

- Press the  button.
- After the “Listening” prompt and the following beep, say “Send message to John Smith mobile”.
- After the system prompts you for what message you want to send, say the message you wish to send or say “List”. There are 18 preset messages.

While the list of defined messages are being read, you can interrupt the system

by pressing the  button and saying the message you want to send.

After the system confirms that you want to send your message to John Smith, your message will be sent.

[art=cto-35984.tif](#) [NO TRANS](#)



List of Preset Messages:

1. Yes.
2. No.

3. Okay.
4. I can't talk right now.
5. Call me.
6. I'll call you later.
7. I'm on my way.
8. Thanks.
9. I'll be late.
10. I will be <number> minutes late.
11. See you in <number> minutes.
12. Stuck in traffic.
13. Start without me.
14. Where are you?
15. Are you there yet?

**UNDERSTANDING THE FEATURES OF YOUR VEHICLE**

---

16. I need directions.

17. I'm lost.

18. See you later.

When this happens, the connection can generally be reestablished by switching the phone OFF/ON. Your mobile phone is recommended to remain in Bluetooth® ON mode.

**Power-Up**

After switching the ignition key from OFF to either the ON or ACC position, or after a language change, you must wait at least 15 seconds prior to using the system.

**Bluetooth® Communication Link**

Mobile phones have been found to lose connection to the Uconnect™ Phone.

UNDERSTANDING THE FEATURES OF YOUR VEHICLE

Voice Tree

art=030536629.tif TRANSLATE

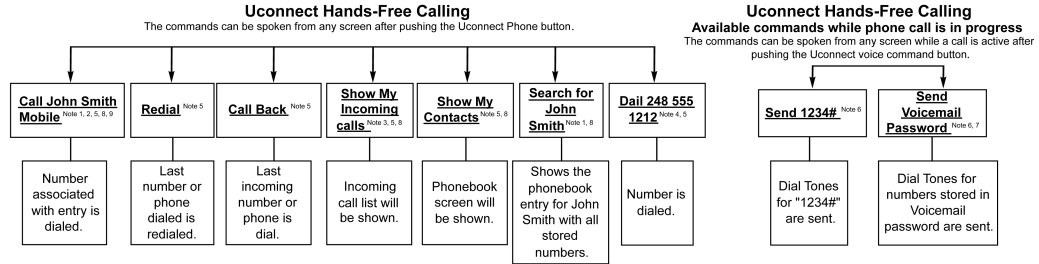

- Notes:
1. You can replace "John Smith" with any name in your mobile or favorites phonebook. You can also say "Call John Smith" and the system will ask you which phone number you want to call for John Smith.
  2. You can replace "Mobile" with "Home", "Work" or "Other".
  3. You can replace "Incoming calls" with "outgoing calls", "missed calls" or "all calls".
  4. You can replace "248 555 1212" with any phone number supported by your Mobile phone.
  5. These commands can be used during a phone call after pushing the Uconnect voice command button <insert talking head icon> on the steering wheel. Please note the call will be muted while the VR session is active.
  6. Send dial tones for automated systems is available while a call is active.
  7. Storing Dial tones in contact names is possible but only the first number encountered in a contact name will be sent. For example if there is a number stored in the Home and Work numbers for the contact Voicemail password only the Home number will be sent.
  8. If your phone does not support phonebook download or call log download over BT than these commands will return a response indicating that the contact does not exist in the phonebook.
  9. Emergency and Towing assistance are contacts that have been pre-loaded in the phonebooks. Commands such as "Call Emergency" and "Call towing assistance" will call the corresponding number stored with those contacts.

Note: Available Voice Commands are shown in bold face and are underlined in the green shaded boxes

030536629

**UNDERSTANDING THE FEATURES OF YOUR VEHICLE** 

UNDERSTANDING THE FEATURES OF YOUR VEHICLE

art=030536630.tif TRANSLATE

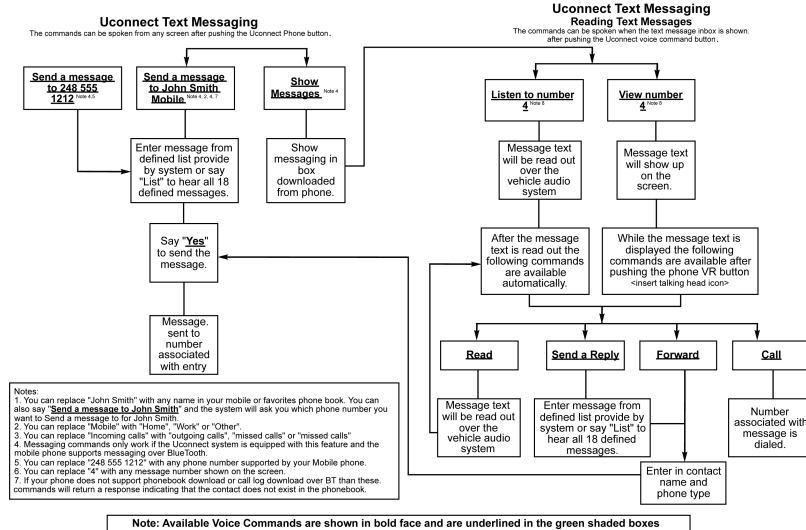

030536630

## UNDERSTANDING THE FEATURES OF YOUR VEHICLE

### General Information

This device complies with Part 15 of the FCC rules and RSS 210 of Industry Canada. Operation is subject to the following conditions:

- Changes or modifications not expressly approved by the party responsible for compliance could void the user's authority to operate the equipment.
- This device may not cause harmful interference.
- This device must accept any interference received, including interference that may cause undesired operation.

### UCONNECT™ VOICE COMMAND 8.4/8.4 Nav

#### Uconnect™ Voice Command System Operation

 The Uconnect™ Voice Command system allows you to control your AM, FM radio, satellite radio, disc player, SD Card, USB/iPod and Sirius Travel Link.

**NOTE:** Take care to speak into the Voice Interface System as calmly and normally as possible. The ability of the Voice Interface System to recognize user voice commands may be negatively affected by rapid speaking or a raised voice level.

### WARNING!

**Any voice commanded system should be used only in safe driving conditions following local laws. All attention should be kept on the roadway ahead. Failure to do so may result in a collision causing serious injury or death.**

When you press the Uconnect™ Voice Command  button, you will hear a beep. The beep is your signal to give a command.

If no command is spoken or recorded the system will say one of three responses:

- I didn't understand
- I didn't get that, etc.,

---

## UNDERSTANDING THE FEATURES OF YOUR VEHICLE

If a command is not spoken or recorded a second time, the system will respond with an error and give some direction as what can be said based on the context you are in. After three consecutive failures of a spoken command or recording the VR session with end.

Pressing the Uconnect™ Voice Command  button while the system is speaking is known as “barging in.” The system will be interrupted, and after the beep, you can say a command. This will become helpful once you start to learn the options.

**NOTE:** *At any time, you can say the words “Cancel” or “Help”.*

These commands are universal and can be used from any menu. All other com-

mands can be used depending upon the active application.

When using this system, you should speak clearly and at a normal speaking volume.

The system will best recognize your speech if the windows are closed, and the heater/air conditioning fan is set to low.

At any point, if the system does not recognize one of your commands, you will be prompted to repeat it.

To hear available commands, press the Uconnect™ Voice Command  button and say “Help”. You will hear available commands for the screen displayed.

### Natural Speech

Natural speech allows the user to speak commands in phrases or complete sen-

tences. The system filters out certain non-word utterances and sounds such as “ah” and “eh”. The system handles fill-in words such as “I would like to”.

The system handles multiple inputs in the same phrase or sentence such as “make a phone call” and “to Kelly Smith”. For multiple inputs in the same phrase or sentence, the system identifies the topic or context and provides the associated follow-up prompt such as “Who do you want to call?” in the case where a phone call was requested but the specific name was not recognized.

The system utilizes continuous dialog; when the system requires more information from the user it will ask a question to which the user can respond without pressing the Push-To-Talk (PTT) button.

## UNDERSTANDING THE FEATURES OF YOUR VEHICLE

### Uconnect™ Voice Commands

The Uconnect™ Voice Command system understands two types of commands. Universal commands are available at all times. Local commands are available if the supported radio mode is active.

Start a dialogue by pressing the Uconnect™ Voice Command  button.

### Changing the Volume

1. Start a dialogue by pressing the Voice Command  button.

2. Say a command (e.g., "Help").

3. Use the ON/OFF VOLUME rotary knob to adjust the volume to a comfortable level while the Voice Command system is speaking. Please note the volume setting for Voice Command is different than the audio system.

### Starting Voice Recognition (VR) Session in Radio/Player Modes

In this mode, you can say the following commands:

**NOTE:** *The commands can be said on any screen when a call is not active after pushing the Uconnect™ Voice Command button.*



### Disc

To switch to the disc mode, say "Change source to Disc". This command can be given in any mode or screen:

- "Track" (#) (to change the track)



UNDERSTANDING THE FEATURES OF YOUR VEHICLE

Voice Tree

art=030536631.tif TRANSLATE

Uconnect Voice Command

AM/FM/Satellite Radio available commands

These commands can be spoken when the AM, FM or Satellite radio is playing, after pushing the Uconnect voice command button.

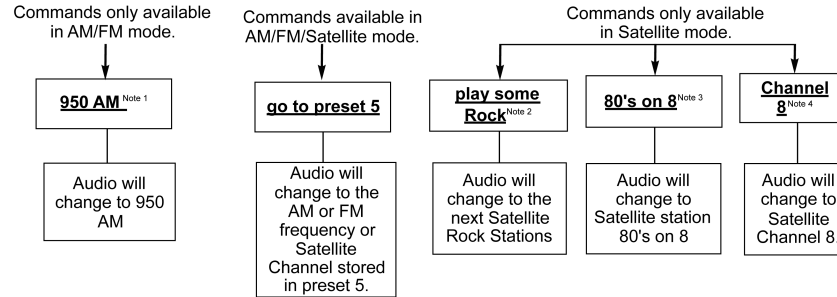

Notes:  
1. You can replace "**950 AM**" with any other AM or FM frequency, such as "**98.7 FM**".  
2. You can replace "**Rock**" with any of the satellite music types.  
3. You can replace "**80's on 8**" with any other satellite station name received by the Radio.  
4. You can replace "**8**" with any other satellite station name received by the Radio.

Note: Available Voice Commands are shown in bold face and are underlined in the green shaded boxes

030536631

**UNDERSTANDING THE FEATURES OF YOUR VEHICLE**

---

UNDERSTANDING THE FEATURES OF YOUR VEHICLE

art=030536938.tif TRANSLATE

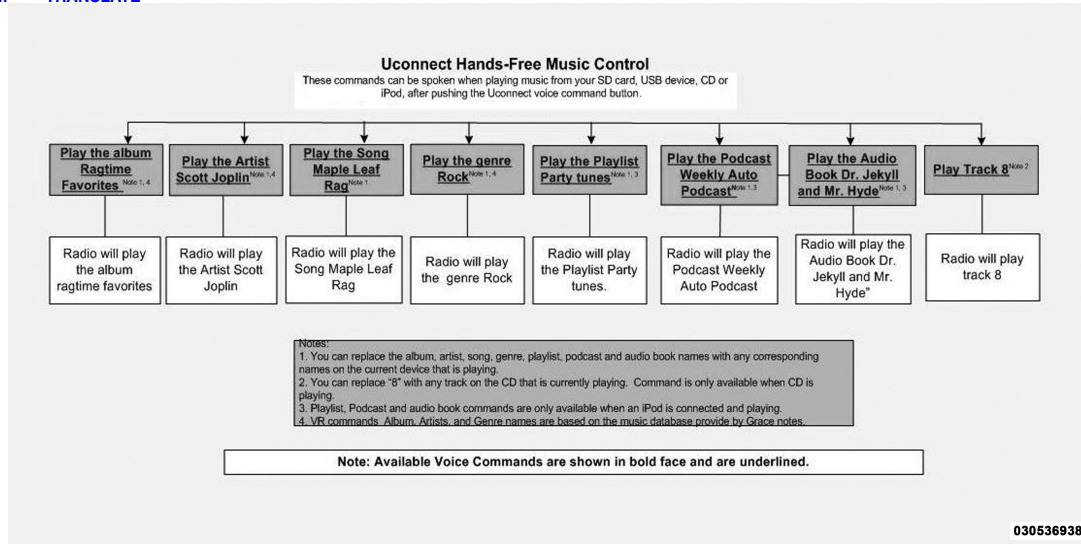

**UNDERSTANDING THE FEATURES OF YOUR VEHICLE**

---

UNDERSTANDING THE FEATURES OF YOUR VEHICLE

art=030536937.tif TRANSLATE

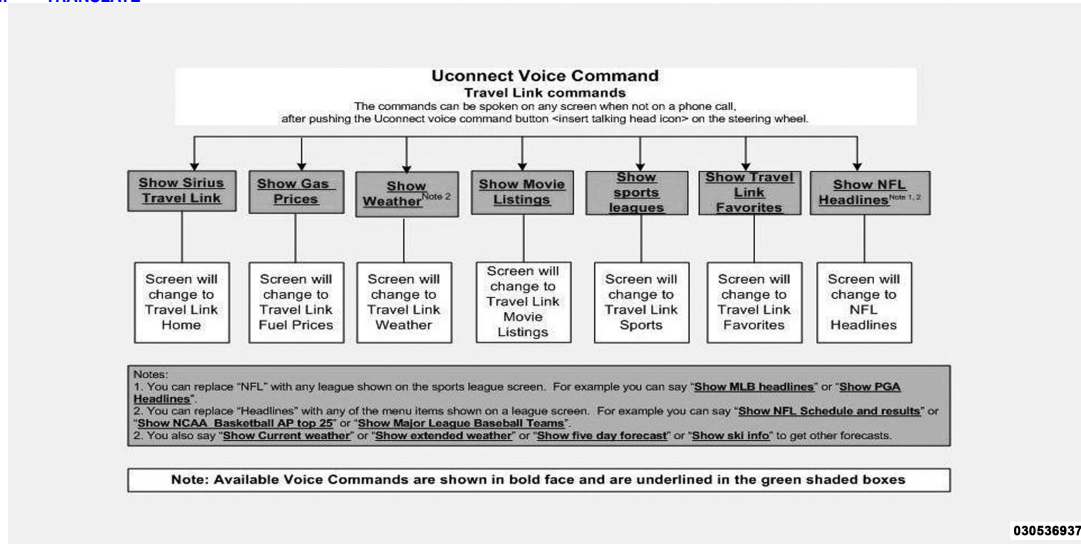

**UNDERSTANDING THE FEATURES OF YOUR VEHICLE** 

UNDERSTANDING THE FEATURES OF YOUR VEHICLE

art=030536939.tif TRANSLATE

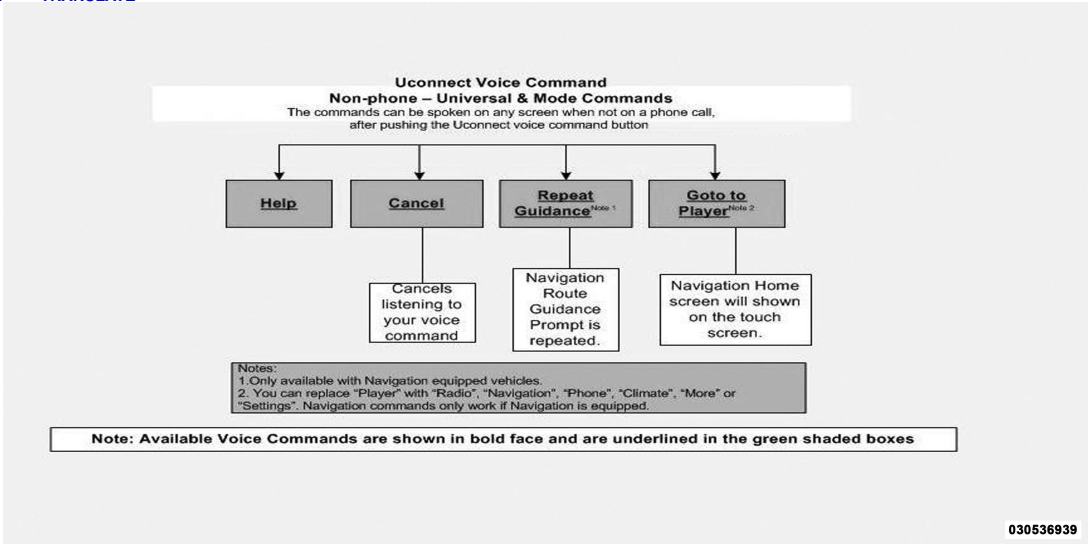

## UNDERSTANDING THE FEATURES OF YOUR VEHICLE

### SEATS

Seats are a part of the Occupant Restraint System of the vehicle.

#### WARNING!

- It is dangerous to ride in a cargo area, inside or outside of a vehicle. In a collision, people riding in these areas are more likely to be seriously injured or killed.
- Do not allow people to ride in any area of your vehicle that is not equipped with seats and seat belts. In a collision, people riding in these areas are more likely to be seriously injured or killed.
- Be sure everyone in your vehicle is in a seat and using a seat belt properly.

### Driver's Power Seat — If Equipped

The power seat switch is on the outboard side of the seat near the floor. Use this switch to move the seat up, down, forward, rearward or to tilt the seat.

art=030936173.tif NO TRANS

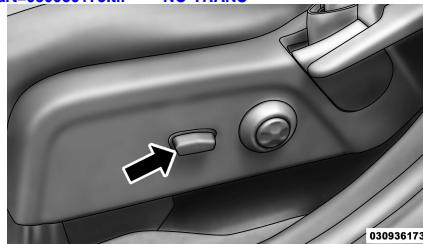

Power Seat Switch

### Adjusting The Seat Forward Or Rearward

The seat can be adjusted both forward and rearward. Push the seat switch for-

ward or rearward; the seat will move in the direction of the switch. Release the switch when the desired position is reached.

### Adjusting The Seat Up Or Down

The height of the seats can be adjusted up or down. Pull upward or push downward on the seat switch; the seat will move in the direction of the switch. Release the switch when the desired position is reached.

### Tilting The Seat Up Or Down

The angle of the seat cushion can be adjusted in four directions. Pull upward or push downward on the front or rear of the seat switch; the front or rear of the seat cushion will move in the direction of the switch. Release the switch when the desired position is reached.



UNDERSTANDING THE FEATURES OF YOUR VEHICLE

**WARNING!**

- Adjusting a seat while driving may be dangerous. Moving a seat while driving could result in loss of control which could cause a collision and serious injury or death.
- Seats should be adjusted before fastening the seatbelts and while the vehicle is parked. Serious injury or death could result from a poorly adjusted seatbelt.
- **Do not ride with the seatback reclined so that the shoulder belt is no longer resting against your chest. In a collision you could slide under the seat belt, which could result in serious injury or death.**

**CAUTION!**

Do not place any article under a power seat or impede its ability to move as it may cause damage to the seat controls. Seat travel may become limited if movement is stopped by an obstruction in the seat's path.

**Power Lumbar — If Equipped**

The Power Lumbar switch is located on the outboard side of the driver's seat. Push the switch forward to increase the lumbar support. Push the switch rearward to decrease the lumbar support. Pushing upward or downward on the switch will raise or lower the position of the support.

art=030936174.tif NO TRANS

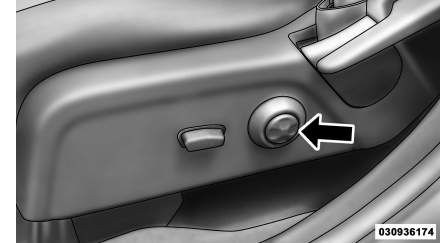

Power Lumbar Switch

**Heated Seats — If Equipped**

On some models, the front driver and passenger seats may be equipped with heaters in both the seat cushions and seatbacks. The heated seats are operated using the Uconnect™ Touch System.

## UNDERSTANDING THE FEATURES OF YOUR VEHICLE

### For Vehicles Equipped With Uconnect Touch™ 4.3:

Touch the CLIMATE hard-key (located on the left side of the Uconnect Touch™ display) to enter the climate control screen.

[art=030902460.tif](#) NO TRANS



Touch the “Driver” or “Pass” seat soft-key (located on the Uconnect Touch™ display) once to select HI-level heating. Touch the soft-key a second time to select LO-level heating. Touch the soft-key a third time to shut the heating elements OFF.

### For Vehicles Equipped With Uconnect Touch™ 8.3 and 8.3 Nav:

Touch the “Controls” soft-key located on the Uconnect Touch™ display.

[art=030902460.tif](#) NO TRANS



Touch the “Driver” or “Passenger” seat soft-key once to select HI-level heating. Touch the soft-key a second time to select LO-level heating. Touch the soft-key a third time to shut the heating elements OFF.

**NOTE:** *Once a heat setting is selected, heat will be felt within two to five minutes.*

When the HI-level setting is selected, the heater will provide a boosted heat level during the first four minutes of operation. Then, the heat output will drop to the normal HI-level. If the HI-level setting is selected, the system will automatically switch to LO-level after a maximum of 60 minutes of continuous operation. At that time, the display will change from HI to LO, indicating the change. The LO-level

setting will turn OFF automatically after a maximum of 45 minutes.

### WARNING!

- **Persons who are unable to feel pain to the skin because of advanced age, chronic illness, diabetes, spinal cord injury, medication, alcohol use, exhaustion or other physical condition must exercise care when using the seat heater. It may cause burns even at low temperatures, especially if used for long periods of time.**

## UNDERSTANDING THE FEATURES OF YOUR VEHICLE

- **Do not place anything on the seat that insulates against heat, such as a blanket or cushion. This may cause the seat heater to overheat. Sitting in a seat that has been overheated could cause serious burns due to the increased surface temperature of the seat.**

### CAUTION!

**Repeated overheating of the seat could damage the heating element and/or degrade the material of the seat.**

#### Vehicles Equipped With Remote Start

On models that are equipped with remote start, the driver's heated seat can be programmed to come on during a remote

start. Refer to "Remote Starting System — If Equipped" in "Things To Know Before Starting Your Vehicle" for further information.

#### Manual Front Seat Adjustments

For models equipped with manual seats, the driver and passenger seats can be adjusted forward or rearward by using a bar located by the front of the seat cushion, near the floor.

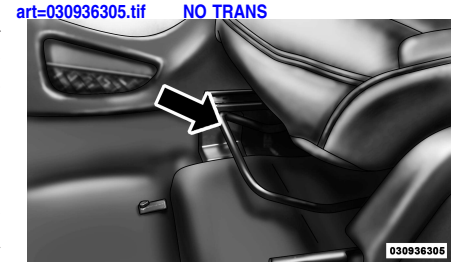

Manual Seat Adjustment

While sitting in the seat, lift up on the bar located and move the seat forward or rearward. Release the bar once the desired position has been reached. Then, using body pressure, move forward and rearward on the seat to be sure that the seat adjusters have latched.

## UNDERSTANDING THE FEATURES OF YOUR VEHICLE

### WARNING!

- Adjusting a seat while driving may be dangerous. Moving a seat while driving could result in loss of control which could cause a collision and serious injury or death.
- Seats should be adjusted before fastening the seatbelts and while the vehicle is parked. Serious injury or death could result from a poorly adjusted seat belt.

### Recliner Adjustment

The recline lever is located on the outboard side of the seat. To recline the seat, lean forward slightly, lift the lever, lean back to the desired position and release the lever. To return the seatback to its normal upright position, lean forward and

lift the lever. Release the lever once the seatback is in the upright position.

art=030936306.tif NO TRANS

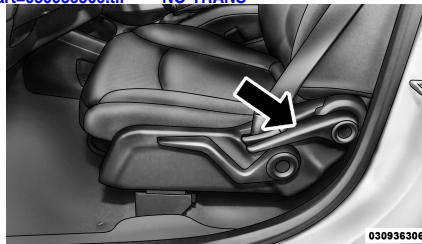

Seatback Release

### WARNING!

- Adjusting a seat while the vehicle is moving is dangerous. The sudden movement of the seat could cause you to lose control. The seat belt might not be adjusted properly and you could be injured. Adjust the seat only while the vehicle is parked.
- Do not ride with the seatback reclined so that the shoulder belt is no longer resting against your chest. In a collision you could slide under the seat belt and be seriously or even fatally injured. Use the recliner only when the vehicle is parked.

**UNDERSTANDING THE FEATURES OF YOUR VEHICLE**

**Driver's Seat Height Adjustment — If Equipped**

The seat height control lever is located on the outboard side of the seat. Raise the lever to raise the seat. Lower the lever to lower the seat. The total seat travel is approximately 2.15 in (55 mm).

art=030936307.tif NO TRANS

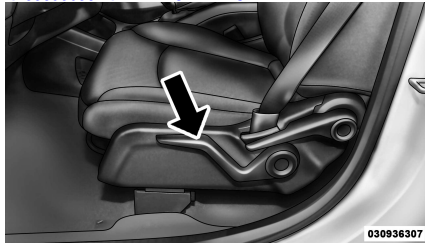

**Seat Height Adjustment Lever**

**Fold-Flat Front Passenger Seat — If Equipped**

This feature allows for extended cargo space. When the seat is folded flat, it is an extension of the load floor surface (allowing long cargo to fit from the rear hatch up to the instrument panel). The fold-flat seat-back also has a hardback surface that you can use as a work surface when the seat is folded flat and the vehicle is not in motion.

art=030936688.tif NO TRANS



**Fold-Flat Seat**

Pull upward on the recline lever to fold or unfold the seat.

**WARNING!**

**Adjusting a seat while the vehicle is moving is dangerous. The sudden movement of the seat could cause you to lose control. Adjust any seat only while the vehicle is parked.**

## UNDERSTANDING THE FEATURES OF YOUR VEHICLE

### Head Restraints

Head restraints are designed to reduce the risk of injury by restricting head movement in the event of a rear impact. Head restraints should be adjusted so that the top of the head restraint is located above the top of your ear.

#### WARNING!

**The head restraints for all occupants must be properly adjusted prior to operating the vehicle or occupying a seat. Head restraints should never be adjusted while the vehicle is in motion. Driving a vehicle with the head restraints improperly adjusted or removed could cause serious injury or death in the event of a collision.**

### Active Head Restraints (AHR) — Front Seats

Active Head Restraints are passive, deployable components, and vehicles with this equipment can not be readily identified by any markings, only through visual inspection of the head restraint. The head restraint will be split in two halves, with the front half being soft foam and trim, the back half being decorative plastic.

When AHRs deploy during a rear impact, the front half of the head restraint extends forward to minimize the gap between the back of the occupant's head and the AHR. This system is designed to help prevent or reduce the extent of injuries to the driver and front passenger in certain types of rear impacts. Refer to "Occupant Restraints" in "Things To Know Before Starting Your Vehicle" for further information.

To raise the head restraint, pull upward on the head restraint. To lower the head restraint, press the push button, located at the base of the head restraint, and push downward on the head restraint.

art=030907490.tif NO TRANS

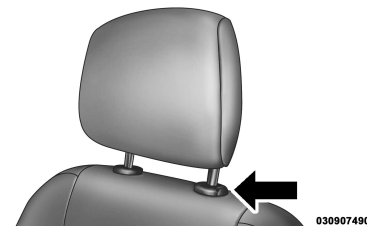

Push Button

For comfort, the Active Head Restraints can be tilted forward and backward. To tilt the head restraint closer to the back of your head, pull forward on the bottom of

**UNDERSTANDING THE FEATURES OF YOUR VEHICLE**

the head restraint. Push rearward on the bottom of the head restraint to move the head restraint away from your head.

art=022607494.tif **NO TRANS**



**Active Head Restraint (Normal Position)**

022607494

art=030907533.tif **NO TRANS**

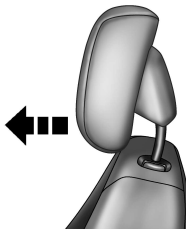

**Active Head Restraint (Tilted)**

030907533

**NOTE:**

- *The head restraints should only be removed by qualified technicians, for service purposes only. If either of the head restraints require removal, see your authorized dealer.*
- *In the event of deployment of an Active Head Restraint, refer to "Occupant Restraints/Supplemental Active Head Restraints (AHR)/Resetting Active Head*

*Restraints (AHR)" in "Things To Know Before Starting Your Vehicle" for further information.*

**WARNING!**

- **Do not place items over the top of the Active Head Restraint, such as coats, seat covers or portable DVD players. These items may interfere with the operation of the Active Head Restraint in the event of a collision and could result in serious injury or death.**

## UNDERSTANDING THE FEATURES OF YOUR VEHICLE

- Active Head Restraints may be deployed if they are struck by an object such as a hand, foot or loose cargo. To avoid accidental deployment of the Active Head Restraint ensure that all cargo is secured, as loose cargo could contact the Active Head Restraint during sudden stops. Failure to follow this warning could cause personal injury if the Active Head Restraint is deployed.

### Head Restraints — Second Row Seats

The rear seats are equipped with adjustable head restraints. To raise the head restraint, pull upward on the head restraint. To lower the head restraint, press the adjustment button, located on the base of the head restraint, and push downward on the head restraint.

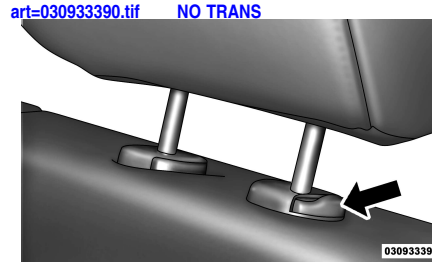

Adjustment Button

### NOTE:

- The head restraints should only be removed by qualified technicians, for service purposes only. If any of the head restraints require removal, see your authorized dealer.
- For proper routing of a Child Seat Tether, refer to "Occupant Restraints" in "Things To Know Before Starting Your Vehicle".

### WARNING!

Driving a vehicle with the head restraints removed or improperly adjusted could cause serious injury or death in the event of a collision. The head restraints should be checked prior to operating the vehicle and never adjusted while the vehicle is in motion.

### Third Row Passenger Seats — Seven Passenger Models

These head restraints are non-adjustable and non-removable. However, you can fold them forward when they are not in use by passengers. Refer to "50/50 Split Third-Row Passenger Seats With Fold-Flat Feature — Seven Passenger Models" for further information.



**UNDERSTANDING THE FEATURES OF YOUR VEHICLE**

**WARNING!**

Do not allow a passenger to sit in a third row seat without having the head restraint unfolded and locked in place. Failure to follow this warning may result in personal injury to the passenger in the event of a collision.

**60/40 Split Second-Row Passenger Seats**

To provide additional storage area, each second-row passenger seat can be folded flat. This allows for extended cargo space and still maintains some seating room if needed.

**NOTE:** *Prior to folding the second-row passenger seat, make sure the front seat-back is not in a reclined position. This will allow the second-row seat to fold easily.*

**WARNING!**

- It is extremely dangerous to ride in a cargo area, inside or outside of a vehicle. In a collision, people riding in these areas are more likely to be seriously injured or killed.
- Do not allow people to ride in any area of your vehicle that is not equipped with seats and seat belts.
- **Be sure everyone in your vehicle is in a seat and using a seat belt properly.**

- On seven passenger models, do not allow a passenger to sit in a third row seat with the second row seatback(s) folded flat. In a collision, the passenger could slide underneath the seat belt and be seriously or even fatally injured.

**To Fold The Seat**

1. Locate the control lever on the lower outboard side of the seat.

## UNDERSTANDING THE FEATURES OF YOUR VEHICLE

art=030936308.tif NO TRANS



**Seatback Release**

2. Place one hand on the seatback and apply a gentle pressure.
3. Lift the control lever with the other hand, allow the seatback to move forward slightly, and then release the lever.

### WARNING!

**To prevent personal injury or damage to objects, keep your head, arms, and objects out of the folding path of the seatback.**

4. Gently guide the seatback into the folded position.

### To Unfold The Seat

Raise the seatback and lock it in place.

### WARNING!

**Be certain that the seatback is locked securely into position. Otherwise, the seat will not provide the proper stability for child seats and/or passengers. An improperly latched seat could cause serious injury.**

### Forward And Rearward Adjustment

The control lever is on the outboard side of the seat. Lift the lever to move the seat forward or rearward. Release the lever once the seat is in the desired position. Then, using body pressure, move forward and rearward on the seat to be sure that the seat adjusters have latched.

art=030936310.tif NO TRANS



**Manual Seat Adjustment**

UNDERSTANDING THE FEATURES OF YOUR VEHICLE

**WARNING!**

Adjusting a seat while the vehicle is moving is dangerous. The sudden movement of the seat could cause you to lose control. The seat belt might not be adjusted properly and you could be injured. Adjust any seat only while the vehicle is parked.

**Recliner Adjustment**

The recline lever is on the outboard side of the seat. To recline the seatback, lean back, lift the lever, position the seatback as desired, and then release the lever. To return the seatback to its normal upright position, lean back, lift the lever, lean forward, and then release the lever once the seatback is in the upright position.

art=030936308.tif NO TRANS

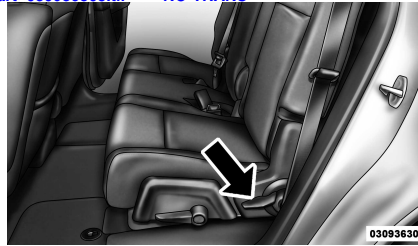

Recline Lever

**WARNING!**

- Adjusting a seat while the vehicle is moving is dangerous. The sudden movement of the seat could cause you to lose control. The seat belt might not be adjusted properly and you could be injured. Adjust the seat only while the vehicle is parked.
- Do not ride with the seatback reclined so that the shoulder belt is no longer resting against your chest. In a collision you could slide under the seat belt and be seriously or even fatally injured. Use the recliner only when the vehicle is parked.

## UNDERSTANDING THE FEATURES OF YOUR VEHICLE

### Seatback/Armrest — Second Row Passenger Seat

The latch release-loop is located at the top of the seatback/armrest. Pull the release-loop forward to release the latch and then downward to lower the seatback/armrest.

art=035137397.tif NO TRANS

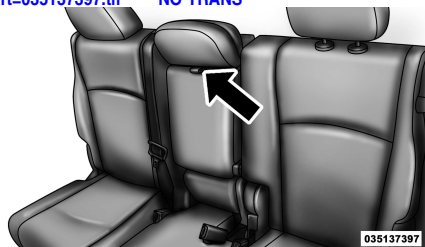

Seatback/Armrest

Raise the seatback/armrest and lock it in place when not in use, or when additional seating area is required.

### WARNING!

**Keep the latch clean and free of objects and be certain that the seatback/armrest is locked securely into position. Otherwise, the seat will not provide the proper stability for child seats and/or passengers. An improperly latched seat could cause serious injury.**

### Stadium Tip 'n Slide™ (Easy Entry/Exit Seat) — Seven Passenger Models

This feature allows passengers to easily enter or exit the third-row passenger seats from either side of the vehicle.

### To Move The Second-Row Passenger Seat Forward

**NOTE:** Raise the seatback/armrest before moving the seat to allow for full seat travel.

Move the control lever on the upper outboard side of the seatback forward. Then, in one fluid motion, the seat cushion flips upward and the seat moves forward on its tracks.

**UNDERSTANDING THE FEATURES OF YOUR VEHICLE**

art=030936689.tif NO TRANS

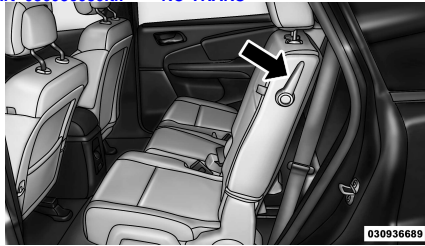

**NOTE:** A hand-grip is molded into the front of each quarter trim panel near the door opening to assist entry and exit from the third-row passenger seats.

2. Push the seat cushion downward to lock it in place.

3. Adjust the seat track position as desired. Using body pressure, move forward and rearward on the seat to be sure that the seat adjusters have latched.

**WARNING!**

**Do not drive the vehicle with the seat in this position, as it is only intended for entering and exiting the third row seats. Failure to follow this warning may result in personal injury.**

**WARNING!**

**Be certain that the seatback and seat are locked securely into position. Otherwise, the seat will not provide the proper stability for child seats and/or passengers. An improperly latched seat could cause serious injury.**

Tip 'n Slide™ Control Lever art=030936690.tif NO TRANS



**To Unfold And Move The Second-Row Passenger Seat Rearward**

1. Move the seatback rearward until it locks in place and then continue sliding the seat rearward on its tracks until it locks in place.

**Tip n Slide Seat™**

## UNDERSTANDING THE FEATURES OF YOUR VEHICLE

### 50/50 Split Third-Row Passenger Seats With Fold-Flat Feature — Seven Passenger Models

To provide additional storage area, each third-row passenger seatback can be folded flat. This allows for extended cargo space and still maintains some rear seating room if needed.

**NOTE:** *Prior to folding the third-row passenger seatback, make sure the second-row passenger seatback is not in a reclined position. This will allow the seatback to fold easily.*

#### To Fold The Seatback

Pull the latch release-loop located at the top of the seatback upward, push the seatback forward slightly, and release the release-loop. Then, continue to push the

seatback forward. The head restraints will fold automatically as the seatback moves forward.

art=030936692.tif NO TRANS

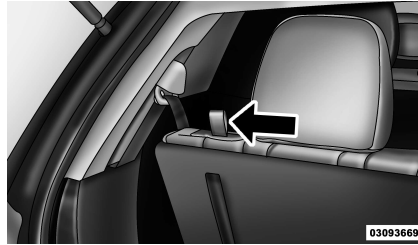

Seatback Release

#### To Unfold The Seatback

Grasp the assist strap loop on the seatback and pull it toward you to raise the seatback. Continue to raise the seatback until it locks in place. Raise the head restraint to lock it in place.

art=030936693.tif NO TRANS

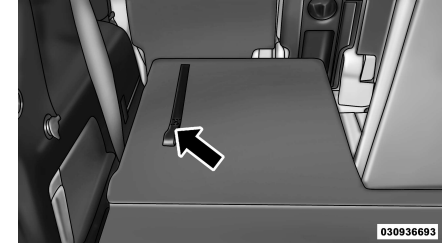

Assist Strap

The seatback can also be locked in the reclined position. To do so, pull the latch release-loop located at the top of the seatback upward, allow the seatback to recline, and release the release-loop.

## UNDERSTANDING THE FEATURES OF YOUR VEHICLE

### WARNING!

- Be certain that the seatback is locked securely into position. Otherwise, the seat will not provide the proper stability for passengers. An improperly latched seat could cause serious injury.
- Do not allow a passenger to sit in a third row seat without having the head restraint unfolded and locked in place. Failure to follow this warning may result in personal injury to the passenger in the event of a collision.

- Do not allow a passenger to sit in a third row seat with the second row seatback(s) folded flat. In a collision, the passenger could slide underneath the seat belt and be seriously or even fatally injured.

### TO OPEN AND CLOSE THE HOOD

Two latches must be released to open the hood.

1. Pull the hood release lever located under the left side of the instrument panel.

art=031336720.tif NO TRANS



Hood Release

2. Outside of the vehicle, locate the safety latch lever near the center of the grille between the grille and hood opening. Push the safety latch lever to the right and then raise the hood.

## UNDERSTANDING THE FEATURES OF YOUR VEHICLE

art=031307222.tif NO TRANS



031307222

**Underhood Safety Latch**

Use the hood prop rod to secure the hood in the open position. Place the upper end of the prop rod in the hole on the underside of the hood.

art=031336721.tif NO TRANS

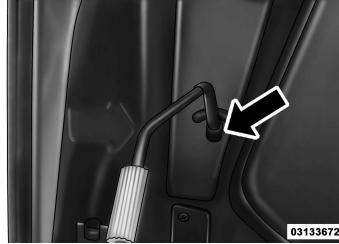

031336721

**Hood Prop Rod**

### CAUTION!

#### To prevent possible damage:

- Before closing hood, make sure the hood prop rod is fully seated into its storage retaining clips.

- Do not slam the hood to close it. Use a firm downward push at the center front edge of the hood to ensure that both latches engage. Never drive your vehicle unless the hood is fully closed, with both latches engaged.

### WARNING!

Be sure the hood is fully latched before driving your vehicle. If the hood is not fully latched, it could open when the vehicle is in motion and block your vision. Failure to follow this warning could result in serious injury or death.



**UNDERSTANDING THE FEATURES OF YOUR VEHICLE**

**LIGHTS**

**Headlight Switch**

The headlight switch is located on the left side of the instrument panel. This switch controls the operation of the headlights, parking lights, instrument panel lights, instrument panel light dimming, interior lights and fog lights.

art=031435213.tif NO TRANS

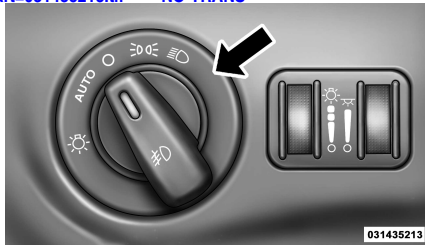

**Headlight Switch**

Rotate the headlight switch clockwise to the first detent for parking lights and instrument panel light operation. Rotate the headlight switch to the second detent for headlight, parking light and instrument panel light operation.

**Automatic Headlights — If Equipped**

This system automatically turns the headlights on or off according to ambient light levels. To turn the system on, rotate the headlight switch counterclockwise to the AUTO position. When the system is on, the headlight time delay feature is also on. This means the headlights will stay on for up to 90 seconds after you turn the ignition switch OFF. To turn the automatic system off, move the headlight switch out of the AUTO position.

**NOTE:** The engine must be running before the headlights will come on in the

*automatic mode.*

**Headlights On With Wipers (Available With Automatic Headlights Only)**

When this feature is active, the headlights will turn on approximately 10 seconds after the wipers are turned on if the headlight switch is placed in the AUTO position. In addition, the headlights will turn off when the wipers are turned off, if they were turned on by this feature.

**NOTE:** The Headlights On with Wipers feature can be turned on and off using the Uconnect Touch™ System, refer to “Uconnect Touch™ Settings” in “Understanding Your Instrument Panel” for further information.

## UNDERSTANDING THE FEATURES OF YOUR VEHICLE

### Headlight Time Delay

This feature provides the safety of headlight illumination for up to 90 seconds when leaving your vehicle in an unlit area.

To activate the delay feature, turn OFF the ignition switch while the headlights are still on. Then, turn off the headlights within 45 seconds. The delay interval begins when the headlight switch is turned off.

**NOTE:** *The lights must be turned off within 45 seconds of turning the ignition OFF to activate this feature.*

If you turn the headlights, parking lights or ignition switch ON again, the system will cancel the delay.

If you turn the headlights off before the ignition, they will turn off in the normal manner.

**NOTE:** *The Headlight Time Delay is programmable using the Uconnect Touch™ System, refer to “Uconnect Touch™ Settings — Customer Programmable Features” in “Understanding Your Instrument Panel” for further information.*

### Daytime Running Lights (DRL) — If Equipped

The Daytime Running Lights will turn ON the first time the vehicle is shifted out of PARK, and remain ON unless the parking brake is applied. Upon returning to the PARK position, the DRLs will turn OFF. DRLs will turn OFF when the ignition is switched OFF.

**NOTE:** *The daytime running lights can be turned on and off using the Uconnect Touch™ System, refer to “Uconnect Touch™ Settings — Customer Programmable Features” in “Understanding Your*

*Instrument Panel” for further information.*

### Lights-On Reminder

If the headlights or parking lights are on after the ignition is turned OFF, a chime will sound to alert the driver when the driver's door is opened.

### Fog Lights — If Equipped

The front fog light switch is built into the headlight switch.

[art=031435215.tif](#) NO TRANS



Fog Light Switch

## UNDERSTANDING THE FEATURES OF YOUR VEHICLE

art=031400701.tif NO TRANS

**#D** To activate the front fog lights, turn on the parking lights or the low beam headlights and press the headlight switch. To turn off the front fog lights, either press the headlight switch a second time or turn off the headlight switch.

An indicator light in the instrument cluster illuminates when the fog lights are turned on.

**NOTE:** *The fog lights will operate when the low beam headlights or parking lights are on. However, selecting the high beam headlights will turn off the fog lights.*

### Multifunction Lever

The multifunction lever controls the operation of the turn signals, headlight beam selection and passing lights. The multi-

function lever is located on the left side of the steering column.

art=031536316.tif NO TRANS



Multifunction Lever

### Turn Signals

Move the multifunction lever up or down and the arrows on each side of the instrument cluster flash to show proper operation of the front and rear turn signal lights.

### NOTE:

- *If either light remains on and does not*

*flash, or there is a very fast flash rate, check for a defective outside light bulb. If an indicator fails to light when the lever is moved, it would suggest that the indicator bulb is defective.*

- *A "Turn Signal On" message will appear in the EVIC (if equipped) and a continuous chime will sound if the vehicle is driven more than 1 mile (1.6 km) with either turn signal on.*

### Lane Change Assist

Tap the lever up or down once, without moving beyond the detent, and the turn signal (right or left) will flash three times then automatically turn off.

### High/Low Beam Switch

Push the multifunction lever away from you to switch the headlights to high beam. Pull

## UNDERSTANDING THE FEATURES OF YOUR VEHICLE

the multifunction lever toward you to switch the headlights back to low beam.

### Flash-To-Pass

You can signal another vehicle with your headlights by lightly pulling the multifunction lever toward you. This will turn on the high beams headlights until the lever is released.

### Interior Lights

The interior lights come on when a door is opened.

To protect the battery, the interior lights will turn off automatically 10 minutes after the ignition switch is moved to the LOCK position. This will occur if the interior lights were switched on manually or are on because a door is open. This includes the glove box light, but not the trunk light. To

restore interior light operation, either turn the ignition switch ON or cycle the light switch.

### Dimmer Controls

The dimmer controls are part of the headlight switch and are located on the left side of the instrument panel.

Rotating the left dimmer control upward with the parking lights or headlights on will increase the brightness of the instrument panel lights.

Rotating the right dimmer control upward with the parking lights or headlights on will increase the brightness of the door map pockets and cupholders, if equipped.

art=031435214.tif NO TRANS

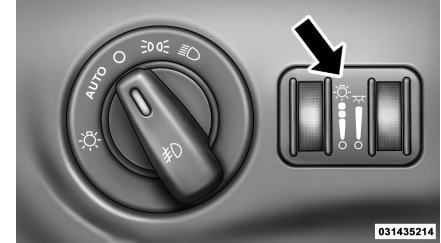

Dimmer Controls

### Dome Light Position

Rotate the dimmer control completely upward to the second detent to turn on the interior lights. The interior lights will remain on when the dimmer control is in this position.

### Interior Light Defeat (OFF)

Rotate the dimmer control to the extreme bottom off position. The interior lights will remain off when the doors are open.

**UNDERSTANDING THE FEATURES OF YOUR VEHICLE**

**Parade Mode (Daytime Brightness Feature)**

Rotate the dimmer control upward to the first detent. This feature brightens all text displays such as the odometer, EVIC (if equipped), and radio when the parking lights or headlights are on.

**Map/Reading Lights**

These lights are mounted between the sun visors on the overhead console. Refer to "Overhead Console" in "Understanding The Features Of Your Vehicle" for further information.

**WINDSHIELD WIPERS AND WASHERS**

The windshield wiper/washer control lever is located on the left side of the steering column.

art=031536316.tif NO TRANS



**Windshield Wiper/Washer Lever**

The front wipers are operated by rotating a switch, located at the end of the lever. For information on using the rear window wiper/washer, refer to "Rear Window Features" in "Understanding The Features Of Your Vehicle".

**Intermittent Wiper System**

Use the intermittent wiper system when weather conditions make a single wiping cycle, with a variable pause between

cycles, desirable. Rotate the end of the windshield wiper/washer control lever to one of the first five detents to select the desired delay interval.

art=031536317.tif NO TRANS



**Front Wiper Control**

There are five delay settings, which allow you to regulate the wipe interval from a minimum of one cycle every second to a maximum of approximately 36 seconds between cycles at vehicle speeds below

## UNDERSTANDING THE FEATURES OF YOUR VEHICLE

10 mph (16 km/h). At speeds greater than 10 mph (16 km/h), the delay varies to a maximum of approximately 18 seconds between cycles.

**NOTE:** The wiper delay times depend on vehicle speed. If the vehicle is moving less than 10 mph (16 km/h), delay times will be doubled.

### Windshield Wiper Operation

Rotate the end of the lever upward, to the first detent past the intermittent settings for low-speed wiper operation.

Rotate the end of the lever upward to the second detent past the intermittent settings for high-speed wiper operation.

art=031536317.tif NO TRANS



Front Wiper Control

**NOTE:** The wipers will automatically return to the “park” position if you turn OFF the ignition switch while they are operating. The wipers will resume operation when you turn the ignition switch back to the ON position.

### CAUTION!

- Turn the windshield wipers OFF when driving through an automatic car wash. Damage to the windshield wipers may result if the wiper control is left in any position other than OFF.
- In cold weather, always turn OFF the wiper switch and allow the wipers to return to the park position before turning OFF the engine. If the wiper switch is left ON and the wipers freeze to the windshield, damage to the wiper motor may occur when the vehicle is restarted.

## UNDERSTANDING THE FEATURES OF YOUR VEHICLE

- **Always remove any buildup of snow that prevents the windshield wiper blades from returning to the “park” position. If the windshield wiper control is turned OFF, and the blades cannot return to the “park” position, damage to the wiper motor may occur.**

### Windshield Washers

To use the windshield washer, push the washer knob, located on the end of the multifunction lever, inward to the second detent.

If you activate the washer while the wiper control is in the delay range, the wipers will operate in low-speed for two or three wipe cycles after releasing the lever and then resume the intermittent interval previously selected.

If you activate the washer while the wiper control is in the OFF position, the wipers will operate for two or three wipe cycles and then turn OFF.

### WARNING!

**Sudden loss of visibility through the windshield could lead to a collision. You might not see other vehicles or other obstacles. To avoid sudden icing of the windshield during freezing weather, warm the windshield with the defroster before and during windshield washer use.**

### Mist Feature

Push the washer knob, located on the end of the multifunction lever, inward to the first detent to activate a single wipe cycle to clear the windshield of road mist or spray

from a passing vehicle. The wipers will continue to operate until you release the lever.

### Headlights With Wipers (Available With Automatic Headlights Only)

When this feature is active, the headlights will turn on approximately 10 seconds after the wipers are turned ON if the multifunction lever (on the left side of the steering column) is placed in the AUTO position. In addition, the headlights will turn off when the wipers are turned OFF if they were turned ON by this feature.

**NOTE:** The “Headlights With Wipers” feature can be turned on and off using the Uconnect Touch™ System, refer to “Uconnect Touch™ Settings” in “Understanding Your Instrument Panel” for further information.

## UNDERSTANDING THE FEATURES OF YOUR VEHICLE

### TILT/TELESCOPING STEERING COLUMN

This feature allows you to tilt the steering column upward or downward. It also allows you to lengthen or shorten the steering column. The tilt/telescoping control handle is located below the steering wheel at the end of the steering column.

art=031736722.tif NO TRANS

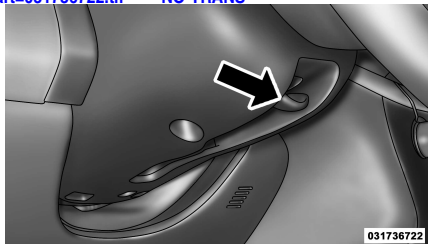

Tilt/Telescoping Steering Control Handle

To unlock the steering column, push the control handle downward. To tilt the steering column, move the steering wheel upward or downward as desired. To lengthen or shorten the steering column, pull the steering wheel outward or push it inward as desired. To lock the steering column in position, pull the control handle upward until fully engaged.

### WARNING!

**Do not adjust the steering column while driving. Adjusting the steering column while driving or driving with the steering column unlocked could cause the driver to lose control of the vehicle. Be sure the steering column is locked before driving your vehicle. Failure to follow this warning may result in serious injury or death.**

### ELECTRONIC SPEED CONTROL — IF EQUIPPED

When engaged, the Electronic Speed Control takes over accelerator operations at speeds greater than 25 mph (40 km/h).

The Electronic Speed Control buttons are located on the right side of the steering wheel.



**UNDERSTANDING THE FEATURES OF YOUR VEHICLE**

art=032209541.tif NO TRANS

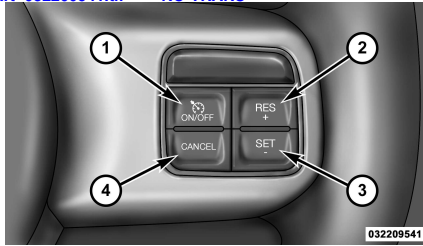

- |            |           |
|------------|-----------|
| 1 — ON/OFF | 2 — RES + |
| 4 — CANCEL | 3 — SET - |

**NOTE:** In order to ensure proper operation, the Electronic Speed Control System has been designed to shut down if multiple Speed Control functions are operated at the same time. If this occurs, the Electronic Speed Control System can be reactivated by pushing the Electronic Speed Control ON/OFF button and resetting the desired vehicle set speed.

**To Activate**

Push the ON/OFF button. The Cruise Indicator Light in the instrument cluster will illuminate. To turn the system off, push the ON/OFF button a second time. The Cruise Indicator Light will turn off. The system should be turned off when not in use.

**To Set A Desired Speed**

Turn the Electronic Speed Control ON. When the vehicle has reached the desired speed, press the SET (-) button and release. Release the accelerator and the vehicle will operate at the selected speed.

**NOTE:** The vehicle should be traveling at a steady speed and on level ground before pressing the SET button.

**WARNING!**

**Leaving the Electronic Speed Control system on when not in use is dangerous. You could accidentally set the system or cause it to go faster than you want. You could lose control and have an accident. Always leave the system OFF when you are not using it.**

**To Deactivate**

A soft tap on the brake pedal, pushing the CANCEL button, or normal brake pressure while slowing the vehicle will deactivate Electronic Speed Control without erasing the set speed memory. Pressing the ON/OFF button or turning the ignition switch OFF erases the set speed memory.

## UNDERSTANDING THE FEATURES OF YOUR VEHICLE

### To Resume Speed

To resume a previously set speed, push the RES (+) button and release. Resume can be used at any speed above 20 mph (32 km/h).

### To Vary The Speed Setting

When the Electronic Speed Control is set, you can increase speed by pushing the RES (+) button. If the button is continually pressed, the set speed will continue to increase until the button is released, then the new set speed will be established.

Pressing the RES (+) button once will result in a 1 mph (2 km/h) increase in set speed. Each subsequent tap of the button results in an increase of 1 mph (2 km/h).

To decrease speed while the Electronic Speed Control is set, push the SET (-) button. If the button is continually held in

the SET (-) position, the set speed will continue to decrease until the button is released. Release the button when the desired speed is reached, and the new set speed will be established.

Pressing the SET (-) button once will result in a 1 mph (2 km/h) decrease in set speed. Each subsequent tap of the button results in a decrease of 1 mph (2 km/h).

### To Accelerate For Passing

Press the accelerator as you would normally. When the pedal is released, the vehicle will return to the set speed.

### Using Electronic Speed Control On Hills

The transmission may downshift on hills to maintain the vehicle set speed.

**NOTE:** *The Electronic Speed Control system maintains speed up and down hills. A slight speed change on moderate hills is normal.*

On steep hills, a greater speed loss or gain may occur so it may be preferable to drive without Electronic Speed Control.

### WARNING!

**Electronic Speed Control can be dangerous where the system cannot maintain a constant speed. Your vehicle could go too fast for the conditions, and you could lose control and have an accident. Do not use Electronic Speed Control in heavy traffic or on roads that are winding, icy, snow-covered or slippery.**

---

## UNDERSTANDING THE FEATURES OF YOUR VEHICLE

### **PARKSENSE® REAR PARK ASSIST — IF EQUIPPED**

The ParkSense® Rear Park Assist system provides visual and audible indications of the distance between the rear fascia and a detected obstacle when backing up, e.g. during a parking maneuver. Refer to “ParkSense® System Usage Precautions” for limitations of this system and recommendations.

ParkSense® will retain the last system state (enabled or disabled) from the last ignition cycle when the ignition is changed to the ON/RUN position.

ParkSense® can be active only when the shift lever is in REVERSE. If ParkSense® is enabled at this shift lever position, the system will remain active until the vehicle speed is increased to approximately

11 mph (18 km/h) or above. The system will become active again if the vehicle speed is decreased to speeds less than approximately 10 mph (16 km/h).

#### **ParkSense® Sensors**

The four ParkSense® sensors, located in the rear fascia/bumper, monitor the area behind the vehicle that is within the sensors’ field of view. The sensors can detect obstacles from approximately 12 in (30 cm) up to 79 in (200 cm) from the rear fascia/bumper in the horizontal direction, depending on the location, type and orientation of the obstacle.

#### **ParkSense® Warning Display**

The ParkSense® Warning screen will only be displayed if Sound and Display is selected from the Uconnect Touch™ System. Refer to “Uconnect Touch™ Settings”

in “Understanding Your Instrument Panel” for further information.

The ParkSense® Warning screen is located within the Electronic Vehicle Information Center (EVIC). It provides visual warnings to indicate the distance between the rear fascia/bumper and the detected obstacle. Refer to “Electronic Vehicle Information Center (EVIC)/Settings” in “Understanding Your Instrument Panel” for further information.

#### **ParkSense® Display**

When the vehicle is in REVERSE, the warning display will turn ON indicating the system status.

**UNDERSTANDING THE FEATURES OF YOUR VEHICLE**

art=032835530.tif **NO TRANS**



032835530

The system will indicate a detected obstacle by showing three solid arcs and will produce a one-half second tone. As the vehicle moves closer to the object, the EVIC display will show fewer arcs and the sound tone will change from slow, to fast, to continuous.

art=032835532.tif **NO TRANS**



032835532

art=032835529.tif **NO TRANS**  
Rear Park Assist Display

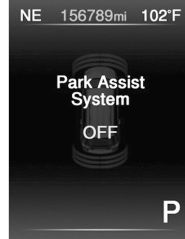

032835529

art=032835531.tif **NO TRANS**



032835531

Slow Tone

art=032835533.tif **NO TRANS**  
Fast Tone



032835533

Continuous Tone

Rear Park Assist OFF

**UNDERSTANDING THE FEATURES OF YOUR VEHICLE**

The vehicle is close to the obstacle when the warning display shows one flashing arc and sounds a continuous tone. The following chart shows the warning alert operation when the system is detecting an obstacle:

WARNING ALERTS					
Rear Distance (in/cm)	Greater than 79 in (200 cm)	79-39 in (200-100 cm)	39-25 in (100-65 cm)	25-12 in (65-30 cm)	Less than 12 in (30 cm)
Audible Alert Chime	None	Single 1/2-Second Tone	Slow	Fast	Continuous
Display Message	Park Assist On	Warning Object Detected	Warning Object Detected	Warning Object Detected	Warning Object Detected
Arcs	None	3 Solid (Continuous)	3 Slow Flashing	2 Slow Flashing	1 Slow Flashing

**Enabling And Disabling ParkSense®**

ParkSense® can be enabled and disabled using the Uconnect Touch™ System. The available choices are: Off, Sound Only, or Sound and Display. Refer to “Uconnect Touch™ Settings” in “Understanding Your Instrument Panel” for further information.

When the ParkSense® soft-key is pressed to disable the system, the EVIC will display the “PARK ASSIST OFF” message for approximately five seconds. Refer to “Electronic Vehicle Information Center (EVIC)” in “Understanding Your Instrument Panel” for further information. When the shift lever is moved to REVERSE and the system is

disabled, the EVIC will display the “PARK ASSIST OFF” message for as long as the vehicle is in REVERSE.

The ParkSense® system uses four sensors located in the rear bumper fascia to scan for obstacles up to 79 in (200 cm) away from the rear bumper fascia. ParkSense®

## UNDERSTANDING THE FEATURES OF YOUR VEHICLE

provides both visual and audible warnings to indicate the range of the object.

### **Service The ParkSense® Rear Park Assist System**

When the ParkSense® Rear Park Assist system is malfunctioning, the Electronic Vehicle Information Center (EVIC) will actuate a single chime, once per ignition cycle, and it will display the "CLEAN PARK ASSIST SENSORS" or the "SERVICE PARK ASSIST SYSTEM" message. Refer to "Electronic Vehicle Information Center (EVIC)" in "Understanding Your Instrument Panel" for further information. When the shift lever is moved to REVERSE and the system has detected a fault condition, the EVIC will display the "CLEAN PARK ASSIST SENSORS" or the "SERVICE PARK ASSIST SYSTEM" message for as long as

the vehicle is in REVERSE. Under this condition, ParkSense® will not operate.

If "CLEAN PARK ASSIST SENSORS" appears in the EVIC and the rear fascia/bumper is clean and clear of snow, ice, mud, dirt or other obstruction, see your authorized dealer.

If "SERVICE PARK ASSIST SYSTEM" appears in the EVIC, see your authorized dealer.

### **Cleaning The ParkSense® System**

Clean the ParkSense® sensors with water, car wash soap and a soft cloth. Do not use rough or hard cloths. Do not scratch or poke the sensors. Otherwise, you could damage the sensors.

### **ParkSense® System Usage Precautions**

#### **NOTE:**

- *Ensure that the rear bumper is free of snow, ice, mud, dirt and debris to keep the ParkSense® system operating properly.*
- *Jackhammers, large trucks, and other vibrations could affect the performance of ParkSense®.*
- *When you turn ParkSense® off, the EVIC will display "PARK ASSIST OFF." Furthermore, once you turn ParkSense® off, it remains off until you turn it on again, even if you cycle the ignition key.*
- *When you move the shift lever to the REVERSE position and ParkSense® is turned off, the EVIC will display the*

**UNDERSTANDING THE FEATURES OF YOUR VEHICLE**

*“PARK ASSIST OFF” message for as long as the vehicle is in REVERSE.*

- *Clean the ParkSense® sensors regularly, taking care not to scratch or damage them. The sensors must not be covered with ice, snow, slush, mud, dirt or debris. Failure to do so can result in the system not working properly. The ParkSense® system might not detect an obstacle behind the fascia/bumper, or it could provide a false indication that an obstacle is behind the fascia/bumper.*
- *Objects such as bicycle carriers, trailer hitches, etc., must not be placed within 12 in (30 cm) from the rear fascia/bumper while driving the vehicle. Failure to do so can result in the system misinterpreting a close object as a sensor problem, causing the “SERVICE PARK ASSIST SYSTEM” message to be*

*displayed in the EVIC.*

**CAUTION!**

- **ParkSense® is only a parking aid and it is unable to recognize every obstacle, including small obstacles. Parking curbs might be temporarily detected or not detected at all. Obstacles located above or below the sensors will not be detected when they are in close proximity.**
- **The vehicle must be driven slowly when using ParkSense® in order to be able to stop in time when an obstacle is detected. It is recommended that the driver looks over his/her shoulder when using ParkSense®.**

**WARNING!**

- **Drivers must be careful when backing up even when using the ParkSense® Rear Park Assist system. Always check carefully behind your vehicle, look behind you, and be sure to check for pedestrians, animals, other vehicles, obstructions, and blind spots before backing up. You are responsible for safety and must continue to pay attention to your surroundings. Failure to do so can result in serious injury or death.**

## UNDERSTANDING THE FEATURES OF YOUR VEHICLE

- **Before using the ParkSense® Rear Park Assist system, it is strongly recommended that the ball mount and hitch ball assembly is disconnected from the vehicle when the vehicle is not used for towing. Failure to do so can result in injury or damage to vehicles or obstacles because the hitch ball will be much closer to the obstacle than the rear fascia when the warning display turns on the single flashing arc and sounds the continuous tone. Also, the sensors could detect the ball mount and hitch ball assembly, depending on its size and shape, giving a false indication that an obstacle is behind the vehicle.**

### **PARKVIEW® REAR BACK UP CAMERA — IF EQUIPPED**

Your vehicle may be equipped with the ParkView® Rear Back Up Camera that allows you to see an on-screen image of the rear surroundings of your vehicle whenever the shift lever is put into REVERSE. The image will be displayed on the radio touchscreen display along with a caution note to “check entire surroundings” across the top of the screen. After five seconds this note will disappear. The ParkView® camera is located on the rear of the vehicle above the rear License plate.

When the vehicle is shifted out of REVERSE, the rear camera mode is exited and the navigation or audio screen appears again.

When displayed, static grid lines will illustrate the width of the vehicle while a dashed center-line will indicate the center of the vehicle to assist with parking or aligning to a hitch/receiver. The static grid lines will show separate zones that will help indicate the distance to the rear of the vehicle. The following table shows the approximate distances for each zone:



**UNDERSTANDING THE FEATURES OF YOUR VEHICLE**

Zone	Distance to the rear of the vehicle
Red	0 - 1 ft (0 - 30 cm)
Yellow	1 ft - 3 ft (30 cm - 1 m)
Green	3 ft or greater (1 m or greater)

**WARNING!**

Drivers must be careful when backing up even when using the ParkView® Rear Back Up Camera. Always check carefully behind your vehicle, and be sure to check for pedestrians, animals, other vehicles, obstructions, or blind spots before backing up. You are responsible for the safety of your surroundings and must continue to pay attention while backing up. Failure to do so can result in serious injury or death.

**CAUTION!**

- To avoid vehicle damage, ParkView® should only be used as a parking aid. The ParkView® camera is unable to view every obstacle or object in your drive path.
- To avoid vehicle damage, the vehicle must be driven slowly when using ParkView® to be able to stop in time when an obstacle is seen. It is recommended that the driver look frequently over his/her shoulder when using ParkView®.

**NOTE:** If snow, ice, mud, or any foreign substance builds up on the camera lens, clean the lens, rinse with water, and dry with a soft cloth. Do not cover the lens.

**Turning ParkView® On Or Off — With Touch Screen Radio**

1. Turn the Radio on.
2. Press the “More” soft-key.
3. Press the “Settings” soft-key.
4. Press the “Safety & Driving Assistance” soft-key.

## UNDERSTANDING THE FEATURES OF YOUR VEHICLE

5. Press the check box soft key next to "Parkview® Backup Camera" to enable/disable.

### OVERHEAD CONSOLE

The overhead console contains courtesy/reading lights, storage for sunglasses, an interior observation mirror and an optional power sunroof switch.

art=033436175.tif NO TRANS



Overhead Console

### Courtesy/Reading Lights

The overhead console has two courtesy lights. The lights turn on when a front door, a sliding door or the liftgate is opened. If your vehicle is equipped with Remote Keyless Entry (RKE) the lights will also turn on when the UNLOCK button on the RKE transmitter is pressed. The courtesy lights also function as reading lights. Press in on each lens to turn these lights on while inside the vehicle. Press the lens a second time to turn each light off. You may adjust the direction of these lights by pressing the outside ring, which is identified with four directional arrows.

art=033336482.tif NO TRANS

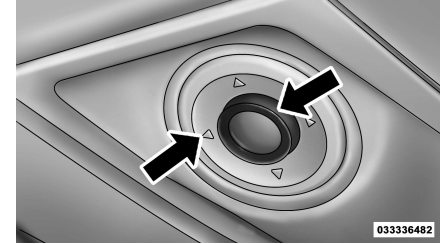

Courtesy/Reading Light

### Sunglasses Storage

To access the storage compartment, press on the raised bars on the compartment door in the center of the console and release and the door will swing downward.

**UNDERSTANDING THE FEATURES OF YOUR VEHICLE**

art=033336723.tif NO TRANS

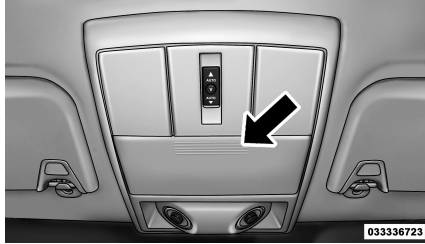

**Sunglass Storage Compartment**

**Interior Observation Mirror**

The convex interior observation mirror provides the driver and front seat passenger a wide field of view to conveniently view passengers sitting in the rear passenger seats. To use the interior observation mirror, press on the raised bars on the compartment door and release (the door will swing downward), then raise the door until it is almost closed and release. The door

will latch in position to use the interior observation mirror.

art=033336726.tif NO TRANS



**Observation Mirror**

**Power Sunroof Switch — If Equipped**

Refer to “Power Sunroof” in “Understanding the Features of Your Vehicle” for further information.

**GARAGE DOOR OPENER — IF EQUIPPED**

HomeLink® replaces up to three remote controls (handheld transmitters) that operate devices such as garage door openers, motorized gates, lighting or home security systems. The HomeLink® unit operates off your vehicle’s battery.

The HomeLink® buttons that are located in the headliner or sun visor designate the three different HomeLink® channels.

## UNDERSTANDING THE FEATURES OF YOUR VEHICLE

art=034000355.tif NO TRANS

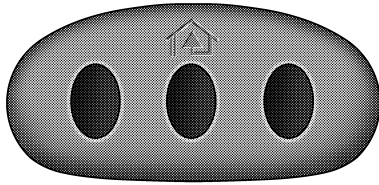

81cb44fe

HomeLink® Buttons

**NOTE:** HomeLink® is disabled when the Vehicle Security Alarm is active.

### WARNING!

- Your motorized door or gate will open and close while you are training the Universal Transceiver. Do not train the transceiver if people, pets or other objects are in the path of the door or gate. Only use this transceiver with a garage door opener that has a “stop and reverse” feature as required by Federal safety standards. This includes most garage door opener models manufactured after 1982. Do not use a garage door opener without these safety features. Call toll-free 1-800-355-3515 or, on the Internet at [www.HomeLink.com](http://www.HomeLink.com) for safety information or assistance.

- Vehicle exhaust contains carbon monoxide, a dangerous gas. Do not run your vehicle in the garage while training the transceiver. Exhaust gas can cause serious injury or death.

### Programming HomeLink®

#### Before You Begin

If you have not trained any of the HomeLink® buttons, erase all channels before you begin training.

To do this, press and hold the two outside buttons for 20 seconds until the red indicator flashes.

It is recommended that a new battery be placed in the handheld transmitter of the device that is being copied to HomeLink®

---

## UNDERSTANDING THE FEATURES OF YOUR VEHICLE

for more efficient training and accurate transmission of the radio-frequency signal.

Your vehicle should be parked outside of the garage when programming.

- Turn the ignition switch to the ON/RUN position.
- Hold the battery side of the handheld transmitter away from the HomeLink® button you wish to program.

Place the handheld transmitter 1–3 in (3–8 cm) away from the HomeLink® button you wish to program while keeping the indicator light in view.

- Simultaneously press and hold both the chosen HomeLink® button and the handheld transmitter button until the HomeLink® indicator changes from a

slow to a rapidly blinking light, then release both the HomeLink® and hand-held transmitter buttons.

Watch for the HomeLink® indicator to change flash rates. When it changes, it is programmed. It may take up to 30 seconds or longer in rare cases. The garage door may open and close while you train.

**NOTE:**

- *Some gate operators and garage door openers may require you to replace Step 3 with procedures noted in the “Gate Operator/Canadian Programming” section.*
- *After training a HomeLink® channel, if the garage door does not operate with HomeLink® and the garage door opener was manufactured after 1995,*

*the garage door opener may have a rolling code. If so, proceed to the heading “Programming A Rolling Code System.”*

- Press and hold the just-trained HomeLink® button and observe the indicator light.

If the indicator light stays on constantly, programming is complete and the garage door (or device) should activate when the HomeLink® button is pressed.

If the indicator light blinks rapidly for two seconds, and then turns to a constant light, continue with programming for a Rolling Code.

## UNDERSTANDING THE FEATURES OF YOUR VEHICLE

### Programming A Rolling Code System

At the garage door opener motor (in the garage), locate the "Learn" or "Training" button.

This can usually be found where the hanging antenna wire is attached to the garage door opener motor (it is NOT the button normally used to open and close the door).

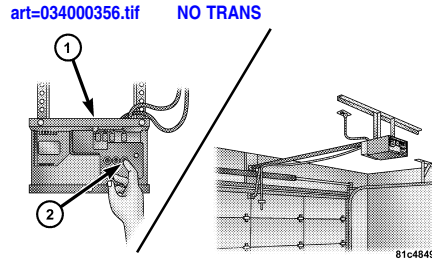

- 1 — Garage Door Opener
- 2 — Training Button

1. Firmly press and release the LEARN or TRAINING button. The name and color of the button may vary by manufacturer.

**NOTE:** You have 30 seconds in which to initiate the next step after the LEARN button has been pressed.

2. Return to the vehicle and press the programmed HomeLink® button twice (holding the button for two seconds each time). If the device is plugged in and activates, programming is complete.

If the device does not activate, press the button a third time (for two seconds) to complete the training.

If you have any problems, or require assistance, please call toll-free 1-800-355-3515 or, on the Internet at [www.HomeLink.com](http://www.HomeLink.com) for information or assistance.

To program the remaining two HomeLink® buttons, repeat each step for each remaining button. DO NOT erase the channels.

---

## UNDERSTANDING THE FEATURES OF YOUR VEHICLE

### Gate Operator/Canadian Programming

Canadian radio-frequency laws require transmitter signals to “time-out” (or quit) after several seconds of transmission – which may not be long enough for HomeLink® to pick up the signal during programming. Similar to this Canadian law, some U.S. gate operators are designed to “time-out” in the same manner.

It may be helpful to unplug the device during the cycling process to prevent possible overheating of the garage door or gate motor.

If you are having difficulties programming a garage door opener or a gate operator, replace “Programming HomeLink®” Step 3 with the following:

**3. Continue to press and hold the HomeLink® button, while you press and**

**release (“cycle”), your handheld transmitter every two seconds until HomeLink® has successfully accepted the frequency signal. The indicator light will flash slowly and then rapidly when fully trained.**

If you unplugged the device for training, plug it back in at this time.

Then proceed with Step 4 under “Programming HomeLink®” earlier in this section.

### Using HomeLink®

To operate, press and release the programmed HomeLink® button. Activation will now occur for the trained device (i.e., garage door opener, gate operator, Security system, entry door lock, home/office lighting, etc.). The handheld transmitter of the device may also be used at any time.

### Reprogramming A Single HomeLink® Button

To reprogram a channel that has been previously trained, follow these steps:

1. Turn the ignition switch to the ON/RUN position.
2. Press and hold the desired HomeLink® button until the indicator light begins to flash after 20 seconds. **Do not release the button.**
3. **Without releasing the button,** proceed with Programming HomeLink® Step 2 and follow all remaining steps.

### Security

It is advised to erase all channels before you sell or turn in your vehicle.

## UNDERSTANDING THE FEATURES OF YOUR VEHICLE

To do this, press and hold the two outside buttons for 20 seconds until the red indicator flashes. Note that all channels will be erased. Individual channels cannot be erased.

The HomeLink® Universal Transceiver is disabled when the Vehicle Security Alarm is active.

### Troubleshooting Tips

If you are having trouble programming HomeLink®, here are some of the most common solutions:

- Replace the battery in the original transmitter.
- Press the LEARN button on the Garage Door Opener to complete the training for a Rolling Code.

- Did you unplug the device for training, and remember to plug it back in?

If you have any problems, or require assistance, please call toll-free 1-800-355-3515 or, on the Internet at [www.HomeLink.com](http://www.HomeLink.com) for information or assistance.

### General Information

This device complies with FCC rules Part 15 and Industry Canada RSS-210. Operation is subject to the following two conditions:

1. This device may not cause harmful interference.
2. This device must accept any interference that may be received including interference that may cause undesired operation.

**NOTE:** *The transmitter has been tested and it complies with FCC and IC rules. Changes or modifications not expressly approved by the party responsible for compliance could void the user's authority to operate the device.*

The term IC before the certification/registration number only signifies that Industry Canada technical specifications were met.

### POWER SUNROOF — IF EQUIPPED

The power sunroof switch is located between the sun visors on the overhead console.



UNDERSTANDING THE FEATURES OF YOUR VEHICLE

art=034236176.tif NO TRANS



Power Sunroof Switch

**WARNING!**

- Never leave children in a vehicle with the key in the ignition switch. Occupants, particularly unattended children, can become entrapped by the power sunroof while operating the power sunroof switch. Such entrapment may result in serious injury or death.
- In a collision, there is a greater risk of being thrown from a vehicle with an open sunroof. You could also be seriously injured or killed. Always fasten your seat belt properly and make sure all passengers are also properly secured.

- Do not allow small children to operate the sunroof. Never allow your fingers, other body parts, or any object to project through the sunroof opening. Injury may result.

**Opening Sunroof — Express**

Press the switch rearward and release it within one-half second and the sunroof will open automatically from any position. The sunroof will open fully and stop automatically. This is called “Express Open”. During Express Open operation, any movement of the sunroof switch will stop the sunroof.

**Sunroof — Manual Mode**

To open the sunroof, press and hold the switch rearward to full open. Any release of the switch will stop the movement and

## UNDERSTANDING THE FEATURES OF YOUR VEHICLE

the sunroof will remain in a partially opened condition until the switch is pushed and held rearward again.

### **Closing Sunroof — Express**

Press the switch forward and release it within one-half second and the sunroof will close automatically from any position. The sunroof will close fully and stop automatically. This is called “Express Close”. During Express Close operation, any movement of the switch will stop the sunroof.

### **Closing Sunroof — Manual Mode**

To close the sunroof, press and hold the switch in the forward position. Any release of the switch will stop the movement and the sunroof will remain in a partially closed condition until the switch is pushed and held forward again.

### **Pinch Protect Feature**

This feature will detect an obstruction in the opening of the sunroof during Express Close operation. If an obstruction in the path of the sunroof is detected, the sunroof will automatically retract. Remove the obstruction if this occurs. Next, press the switch forward and release to Express Close.

### **Pinch Protect Override**

If a known obstruction (ice, debris, etc.) prevents closing, press the switch forward and hold for two seconds after the reversal occurs. This allows the sunroof to move towards the closed position.

**NOTE:** *Pinch protection is disabled while the switch is pressed.*

### **Venting Sunroof — Express**

Press and release the Vent button within one half second and the sunroof will open to the vent position. This is called “Express Vent”, and it will occur regardless of sunroof position. During Express Vent operation, any movement of the switch will stop the sunroof.

### **Sunshade Operation**

The sunshade can be opened manually. However, the sunshade will open automatically as the sunroof opens.

**NOTE:** *The sunshade cannot be closed if the sunroof is open.*

### **Wind Buffeting**

Wind buffeting can be described as the perception of pressure on the ears or a helicopter-type sound in the ears. Your vehicle may exhibit wind buffeting with the

## UNDERSTANDING THE FEATURES OF YOUR VEHICLE

windows down, or when the sunroof is in certain open or partially open positions. This is a normal occurrence and can be minimized. If the buffeting occurs with the rear windows open, then open the front and rear windows together to minimize the buffeting. If the buffeting occurs with the sunroof open, then adjust the sunroof opening to minimize the buffeting or open any window.

### Sunroof Maintenance

Use only a nonabrasive cleaner and a soft cloth to clean the glass panel.

### Ignition Off Operation

For vehicles not equipped with the Electronic Vehicle Information Center (EVIC), the power sunroof switch will remain active for 45 seconds after the ignition switch is turned to the LOCK position. Opening either front door will cancel this feature.

For vehicles equipped with the EVIC, the power sunroof switch will remain active for up to 10 minutes after the ignition switch is turned to the LOCK position. Opening either front door will cancel this feature.

**NOTE:** *The delay time is programmable using the Uconnect™ Touch system. Refer to “Uconnect™ Touch System” in “Understanding Your Instrument Panel” for further information.*

### Sunroof Fully Closed

Press the switch forward and release to ensure that the sunroof is fully closed.

## ELECTRICAL POWER OUTLETS

A 12 Volt (13 Amp) power outlet located in the center console below the radio. The

power outlet has power available when the ignition switch is in the ON/RUN or ACC position.

art=034636177.tif NO TRANS

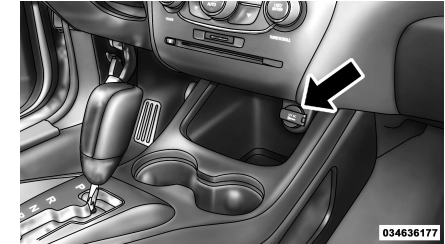

Front Power Outlet

This power outlet will also operate a conventional cigar lighter unit. **To preserve the heating element, do not hold the lighter in the heating position.**

A second 12 Volt (13 Amp) power outlet is located inside the center console storage

## UNDERSTANDING THE FEATURES OF YOUR VEHICLE

area. Power is available with the ignition switch in the ON/RUN, ACC or LOCK position.

art=034636185.tif NO TRANS



**Center Console Power Outlet**

A third fused 12 Volt power outlet is located on the back of the center console. This power outlet has power available when the ignition switch is in the LOCK, ON or ACC position.

art=034607605.tif NO TRANS



**Rear Power Outlet**

A fourth fused 12 Volt power outlet is located on the left quarter trim panel in the cargo area. This power outlet has power available when the ignition switch is in the ON or ACC position.

art=034607606.tif NO TRANS



**Rear Power Outlet**

**NOTE:** To ensure proper operation a MOPAR® knob and element must be used.

UNDERSTANDING THE FEATURES OF YOUR VEHICLE

**CAUTION!**

- Do not exceed the maximum power of 160 Watts (13 Amps) at 12 Volts. If the 160 Watt (13 Amp) power rating is exceeded the fuse protecting the system will need to be replaced.
- The power outlet on the bottom of the center console shares the fuse with the power outlet on the back of the console. The combined usage must not exceed 160 Watts (13 Amps) at 12 Volts.

art=072736472.tif NO TRANS

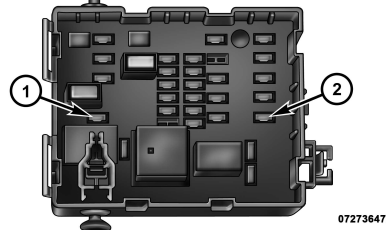

Power Outlet Fuses

- 1 — F103 20 A Yellow Power Outlet Console Bin & Power Outlet Console Rear
- 2 — F102 20 A Yellow Cigar Lighter Instrument Panel & Power Outlet Left Rear Cargo Area

- Only devices designed for use in this type of outlet should be inserted into any 12 Volt outlet.
- Do not touch with wet hands.
- Close the lid when not in use and while driving the vehicle.
- If this outlet is mishandled, it may cause an electric shock and failure.

**WARNING!**

To avoid serious injury or death:

## UNDERSTANDING THE FEATURES OF YOUR VEHICLE

### CAUTION!

- Many accessories that can be plugged in draw power from the vehicle's battery, even when not in use (i.e., cellular phones, etc.). Eventually, if plugged in long enough, the vehicle's battery will discharge sufficiently to degrade battery life and/or prevent the engine from starting.
- Accessories that draw higher power (i.e., coolers, vacuum cleaners, lights, etc.) will degrade the battery even more quickly. Only use these intermittently and with greater caution.

- After the use of high power draw accessories, or long periods of the vehicle not being started (with accessories still plugged in), the vehicle must be driven a sufficient length of time to allow the alternator to recharge the vehicle's battery.
- Power outlets are designed for accessory plugs only. Do not hang any type of accessory or accessory bracket from the plug.

### POWER INVERTER — IF EQUIPPED

Your vehicle may be equipped with a 115 Volt AC (150 Watt maximum) power outlet located on the back of the center console. This outlet can power mobile phones, electronics and other low power devices

requiring power up to 150 Watts. Certain high-end video games, such as Playstation3 and XBox360 will exceed this power limit, as will most power tools.

art=035007607.tif NO TRANS

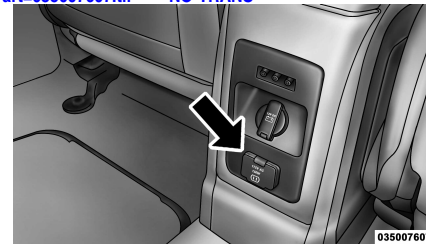

Power Inverter

The power inverter is designed with built-in overload protection. If the power rating of 150 Watts is exceeded, the power inverter will automatically shut down. Once the electrical device has

## UNDERSTANDING THE FEATURES OF YOUR VEHICLE

been removed from the outlet the inverter should automatically reset. If the power rating exceeds approximately 170 Watts, the power inverter may have to be reset manually. To reset the inverter manually press the power inverter button OFF and ON. To avoid overloading the circuit, check the power ratings on electrical devices prior to using the inverter.

**NOTE:** *Due to built-in overload protection, the power outlet will shut down if the 115 Volt AC (150 Watt maximum) power rating is exceeded.*

### WARNING!

**To avoid serious injury or death:**

- **Do not use a three-prong adaptor.**

- **Do not insert any objects into the receptacles.**
- **Do not touch with wet hands.**
- **Close the lid when not in use.**
- **If this outlet is mishandled, it may cause an electric shock and failure.**

### Power Inverter Operation

The power inverter is turned on and off using the Uconnect™ Touch System.

### Vehicles Equipped With Uconnect Touch™ 4.3

To turn the power inverter on or off perform the following:

1. Press the “More” hard-key (located next to the Uconnect Touch™ display).

2. Press the “Outlet” soft-key (located on the Uconnect Touch™ display) to turn the power inverter On or Off.

### Vehicles Equipped With Uconnect Touch™ 8.4 and 8.4 Nav

To enable or disable the power inverter perform the following:

1. Press the “Controls” soft-key.
2. Press the “Outlet” soft-key to turn the power inverter On or Off.

### CUPHOLDERS

There are two cupholders, located in the center floor console, for the front passengers.

## UNDERSTANDING THE FEATURES OF YOUR VEHICLE

art=035136178.tif NO TRANS

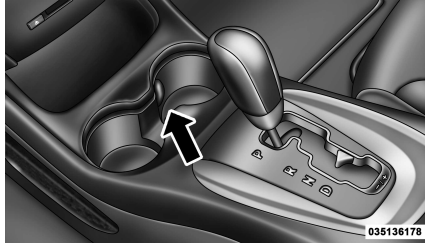

**Floor Console Cupholders**

For passengers in the second row there are two cupholders, located in the center armrest between the two seats.

When the armrest is folded flat the cupholders are in the back of the Head Restraint. The Head Restraint can be adjusted to better position the cupholders.

art=035137398.tif NO TRANS

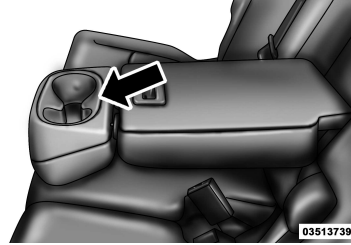

**Armrest Cupholders**

For vehicles equipped with third row seating, there are additional cupholders located in the trim panels.

In addition to cupholders, vehicles may also be equipped with bottle holders. The bottle holders are located on the door trim panels.

art=035236179.tif NO TRANS

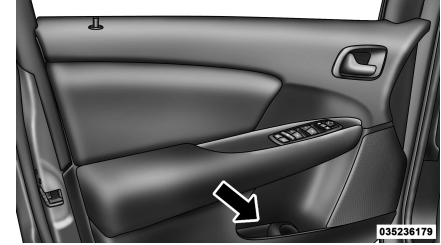

**Door Bottle Holder**

### **WARNING!**

**If containers of hot liquid are placed in the bottle holder, they can spill when the door is closed, burning the occupants. Be careful when closing the doors to avoid injury.**



**UNDERSTANDING THE FEATURES OF YOUR VEHICLE**

**STORAGE**

**Glove Box Storage**

The glove box storage compartment is located on the passenger side of the instrument panel. Pull on the release handle to open the glove box storage compartment.

art=035236181.tif NO TRANS

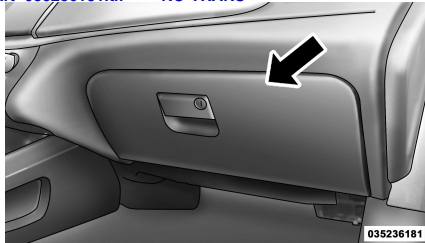

**Glove Box Storage Compartment**

**Floor Console Storage**

An open storage area, or cubby bin, is located in the floor console.

art=035236180.tif NO TRANS

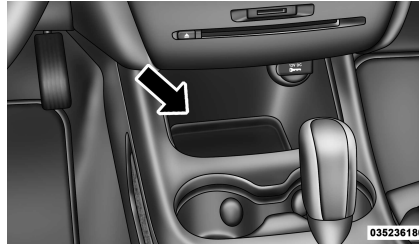

**Floor Console Cubby Bin**

**Center Console Storage**

There is a storage compartment located under the center console armrest.

art=035236182.tif NO TRANS

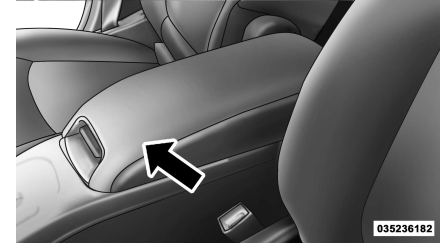

**Center Console**

Pull upward on the release handle, located on the front of the lid, to open the storage compartment.

## UNDERSTANDING THE FEATURES OF YOUR VEHICLE

art=035236183.tif NO TRANS



Opened Storage Compartment

### Sliding Armrest

The center console armrest can also be slid rearward for easy access to the storage area.

art=035236184.tif NO TRANS



Sliding Armrest

### WARNING!

Do not operate this vehicle with a console compartment lid in the open position. Cellular phones, music players, and other handheld electronic devices should be stowed while driving. Use of these devices while driving can cause an accident due to distraction, resulting in death or injury.

### Flip 'n Stow™ Front Passenger Seat Storage — If Equipped

The seat latch release-loop is located in the center of the seat cushion between the seat cushion and the seatback. Pull the loop upward to release the latch and then forward to open the seat to the detent position.

UNDERSTANDING THE FEATURES OF YOUR VEHICLE

art=035207221.tif NO TRANS

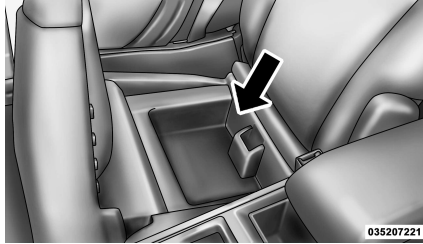

Front Passenger Seat Storage Compartment

**NOTE:** Make sure that objects inside the bin do not interfere with the latch before closing the seat. Push the seat cushion downward after closing it to make sure it latches to the base.

**WARNING!**

Be certain that the seat cushion is locked securely into position before using the seat. Otherwise, the seat will not provide the proper stability for passengers. An improperly latched seat cushion could cause serious injury.

**Second-Row Passenger Seat Temporary Storage Bin**

This is a temporary storage bin designed for use when the seatback/armrest is down. Be sure to remove all items from this bin before raising the seatback/armrest.

**Second-Row Map Pocket And Grocery Retainers — If Equipped**

A map storage pocket and grocery retainers are located on the back of the drivers seatback.

art=035236912.tif NO TRANS



Seat Storage And Grocery Retainers

## UNDERSTANDING THE FEATURES OF YOUR VEHICLE

### In-Floor Storage Bin With Removable Liner

**NOTE:** Position the front seat to at least a mid-track position to provide easier access to the storage bin.

An in-floor storage bin is located behind each front seat. Each 1.6 gal (5.9 l) bin can hold up to 12, 12 oz (0.35 l) cans, plus ice, or other items. The removable bin liner allows for easy filling, emptying, and cleaning.

To access the bin, position the floor mat aside (if equipped). Pull the door latch release-loop upward to release the latch and then forward to open the bin door.

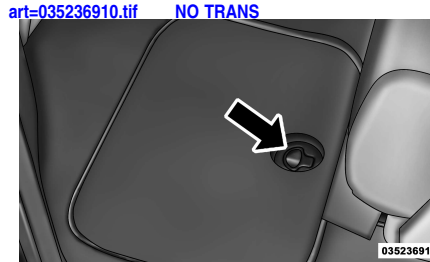

In-Floor Storage

The liner can be removed for easy cleaning by lifting on the notches as shown.

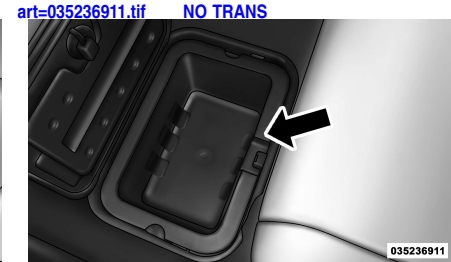

Removable Liner

## CARGO AREA FEATURES

### Rechargeable Flashlight — If Equipped

The rechargeable LED flashlight stores in its charging station in the left rear quarter trim panel. To remove it, press on the indent on the side of the flashlight and release.

## UNDERSTANDING THE FEATURES OF YOUR VEHICLE

art=035236909.tif NO TRANS



**Rechargeable Flashlight**

To operate the flashlight, press the switch once for high, twice for low, and a third time to return to off.

art=035410217.tif NO TRANS

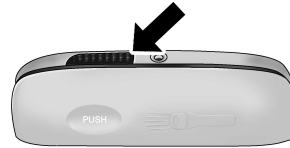

**Three-Press Switch**

**NOTE:** Be sure to return the flashlight to its charging station when not in use to ensure it is ready for operation the next time you need it.

### Cargo Management System

#### Five Passenger System Features

- A raised load floor that sits on top of a large built-in storage bin.

- A tri-fold door built into the load floor that allows easy access to items in the built-in storage bin.
- 60/40 split second-row passenger seats with fold flat feature, which allows for extended cargo space. Refer to "Seats" in "Understanding The Features Of Your Vehicle" for further information.
- An optional front passenger seat with fold flat feature, which extends cargo space even further. Refer to "Seats" in "Understanding The Features Of Your Vehicle" for further information.
- Cargo tie-downs.
- A retractable cargo area cover (if equipped).

## UNDERSTANDING THE FEATURES OF YOUR VEHICLE

### Seven Passenger System Features

- A large built-in storage bin with a hinged hardcover located in the floor behind the third-row passenger seats.
- 60/40 split second-row passenger seats with fold flat feature, which allows for extended cargo space. Refer to “Seats” in “Understanding The Features of Your Vehicle” for further information.
- 50/50 split third-row passenger seats with fold flat feature, which allows for extended cargo space. Refer to “Seats” in “Understanding The Features of Your Vehicle” for further information.
- An optional front passenger seat with fold flat feature, which extends cargo space even further. Refer to “Seats” in

“Understanding The Features of Your Vehicle” for further information.

- Cargo tie-downs.

### Cargo Tie-Downs

#### WARNING!

**Cargo tie-downs are not safe anchors for a child seat tether strap. In a sudden stop or collision, a tie-down could pull loose and allow the child seat to come loose. A child could be badly injured. Use only the anchors provided for child seat tethers.**

Cargo tie-downs are located on both rear trim panels. These tie-downs should be used to secure loads safely when the vehicle is moving.

art=035402568.tif NO TRANS

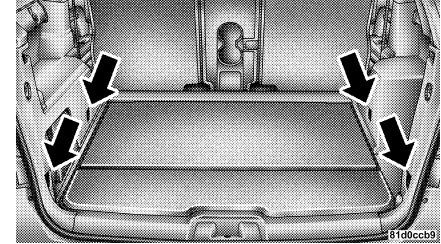

Cargo Tie-Downs

#### WARNING!

**The weight and position of cargo and passengers can change the vehicle center of gravity and vehicle handling. To avoid loss of control resulting in personal injury, follow these guidelines for loading your vehicle:**

---

## UNDERSTANDING THE FEATURES OF YOUR VEHICLE

- Do not carry loads that exceed the load limits described on the label attached to the left door or left door center pillar.
- Always place cargo evenly on the cargo floor. Put heavier objects as low and as far forward as possible.
- Place as much cargo as possible in front of the rear axle. Too much weight or improperly placed weight over or behind the rear axle can cause the vehicle to sway.
- Do not pile luggage or cargo higher than the top of the seatback. This could impair visibility or become a dangerous projectile in a sudden stop or collision.
- To help protect against personal injury, passengers should not be seated in the rear cargo area. The rear cargo space

is intended for load carrying purposes only, not for passengers, who should sit in seats and use seat belts.

### **Retractable Cargo Area Cover (If Equipped) — Five Passenger Models**

**NOTE:** *The purpose of this cover is for privacy, not to secure loads. It will not prevent cargo from shifting or protect passengers from loose cargo.*

The removable retractable cargo area cover mounts in the cargo area behind the top of the rear seats.

The cover, when extended, covers the cargo area to keep items out of sight. Notches in the trim panels near the liftgate opening secure the extended cover in place.

The cover rolls away neatly inside its housing when not in use. You can also remove the cover from the vehicle to make more room in the cargo area.

To install the cover, position it in the vehicle so that the flat side of the housing faces upward. Then, insert either the left or the right spring-loaded post (located on the ends of the cover housing) into the left attachment point or the right attachment point (shown).

## UNDERSTANDING THE FEATURES OF YOUR VEHICLE

art=035402569.tif NO TRANS

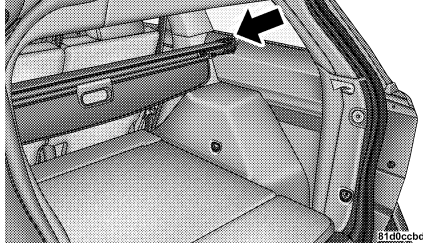

**Installing Retractable Cargo Area Cover**

Insert the spring-loaded post on the opposite end of the cover housing into the attachment point on the opposite side of the vehicle.

Grab the cover handle and pull it toward you. As the cover nears the liftgate opening, guide the rear attachment posts (on both ends of the cover) into the notches in the trim panels. Lower the cover to posi-

tion the posts into the bottom of the notches and release the handle.

art=035402570.tif NO TRANS

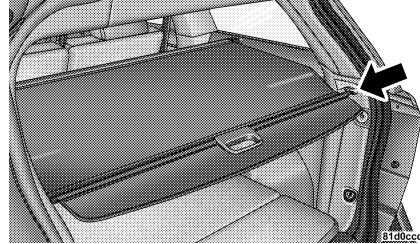

**Positioning Retractable Cargo Area Cover**

### WARNING!

A cargo cover that is unsecured in the vehicle could cause injury in a collision. It could become airborne during a sudden stop and strike someone inside the vehicle. Do not store the cargo cover on the cargo floor or in the passenger compartment. Remove the cover from the vehicle when taken from its mounting. Do not store it in the vehicle.

## REAR WINDOW FEATURES

### Rear Window Wiper/Washer

The rear window wiper/washer control is located on the right side of the steering column.



UNDERSTANDING THE FEATURES OF YOUR VEHICLE

art=031536316.tif NO TRANS



Rear Wiper/Washer

art=036400244.tif NO TRANS



Rotate the switch upward to the first detent position for rear wiper operation.

art=036400246.tif NO TRANS



Rotate the switch upward past the first detent position to activate the rear washer. The washer pump will continue to operate as long as the switch is held. Upon release, the wiper will cycle three times before returning to the set position.

art=036436318.tif NO TRANS



Rear Wiper/Washer Control

If the rear wiper is operating when the ignition is turned to the LOCK position, the wiper will automatically return to the "Park" position. When the vehicle is restarted, the wiper will resume function at whichever position the switch is set at.

**CAUTION!**

- Turn the rear wiper off when driving through an automatic car wash. Damage to the rear wiper may result if the rear wiper switch is left in the on position.
- In cold weather, always turn off the rear wiper switch and allow the rear wiper to return to the park position before turning off the engine. If the rear wiper switch is left on and the rear wiper freezes to the window, damage to the rear wiper motor may occur when the vehicle is restarted.

## UNDERSTANDING THE FEATURES OF YOUR VEHICLE

- Always remove any buildup of snow that prevents the rear wiper blade from returning to the park position. If the rear wiper control is turned off and the blade cannot return to the park position, damage to the rear wiper motor may occur.

### Rear Window Defroster



The rear window defroster button is located on the climate control panel. Press this button to turn on the rear window defroster and the heated outside mirrors (if equipped). An indicator in the button will illuminate when the rear window defroster is on. The rear window defroster automatically turns off after approximately 10 minutes.

**NOTE:** To prevent excessive battery drain, use the rear window defroster only when the engine is operating.

### CAUTION!

Failure to follow these cautions can cause damage to the heating elements:

- Use care when washing the inside of the rear window. Do not use abrasive window cleaners on the interior surface of the window. Use a soft cloth and a mild washing solution, wiping parallel to the heating elements. Labels can be peeled off after soaking with warm water.

- Do not use scrapers, sharp instruments, or abrasive window cleaners on the interior surface of the window.
- Keep all objects a safe distance from the window.

## ROOF LUGGAGE RACK — IF EQUIPPED

The roof rack side rails on your vehicle are NOT designed to carry a load without the addition of crossbars. Crossbars can be purchased from MOPAR® accessories to provide a functional roof rack system.

**NOTE:** Metal crossbars are offered by MOPAR® accessories. See your authorized dealer.

External racks do not increase the total load carrying capacity of the vehicle. Be

**UNDERSTANDING THE FEATURES OF YOUR VEHICLE**

sure that the total occupant and luggage load inside the vehicle plus the load on the luggage rack do not exceed the maximum vehicle load capacity.

The roof rack cross rails and side rails together are designed to carry cargo weight. The load must not exceed 150 lbs (68 kg), and it should be distributed uniformly over the cross rails. In addition, the roof rack does not increase the total load carrying capacity of the vehicle. Be sure the total load of cargo inside the vehicle plus that on the roof rack does not exceed the maximum vehicle load capacity.

**CAUTION!**

- **To avoid damage to the roof rack and vehicle, do not exceed the maximum roof rack load capacity of 150 lbs (68 kg). Always distribute loads as evenly as possible and secure the load appropriately.**
- **Long loads, which extend over the windshield, such as wood panels or surfboards, or loads with large frontal area should be secured to both the front and rear of the vehicle.**
- **Place a blanket or other protection between the surface of the roof and the load.**

- **Travel at reduced speeds and turn corners carefully when carrying large or heavy loads on the roof rack. Wind forces, due to natural causes or nearby truck traffic, can add sudden upward lift to loads. This is especially true on large flat loads and may result in damage to the cargo or your vehicle.**

**WARNING!**

**Cargo must be securely tied before driving your vehicle. Improperly secured loads can fly off the vehicle, particularly at high speeds, resulting in personal injury or property damage. Follow the Roof Rack Cautions when carrying cargo on your roof rack.**



# SECTION 4

## UNDERSTANDING YOUR INSTRUMENT PANEL

• INSTRUMENT PANEL FEATURES . . . . .	195	• Soft-Keys . . . . .	213
• INSTRUMENT CLUSTER . . . . .	196	• Uconnect Touch™ 4.3 Settings — Customer Programmable Features . . . . .	213
• INSTRUMENT CLUSTER DESCRIPTIONS . . . . .	197	• Uconnect Touch™ System 8.4 Settings — Customer Programmable Features . . . . .	223
• ELECTRONIC VEHICLE INFORMATION CENTER (EVIC) . . . . .	204	• VIDEO ENTERTAINMENT SYSTEM (VES)™ — IF EQUIPPED . . . . .	234
• Electronic Vehicle Information Center (EVIC) Displays . . . . .	205	• iPod®/USB/MP3 CONTROL— IF EQUIPPED . . . . .	235
• EVIC White Telltale Lights . . . . .	206	• STEERING WHEEL AUDIO CONTROLS — IF EQUIPPED . . . . .	235
• EVIC Amber Telltale Lights . . . . .	207	• Right-Hand Switch Functions . . . . .	236
• EVIC Red Telltale Lights . . . . .	207	• Left-Hand Switch Functions for Radio Operation . . . . .	236
• Oil Change Required . . . . .	209	• Left-Hand Switch Functions for Media (ie, CD) Operation . . . . .	236
• Fuel Economy . . . . .	210	• CD/DVD DISC MAINTENANCE . . . . .	236
• Vehicle Speed . . . . .	211	• RADIO OPERATION AND MOBILE PHONES . . . . .	237
• Trip Info . . . . .	211	• CLIMATE CONTROLS . . . . .	237
• Units . . . . .	212		
• Vehicle Info (Customer Information Features) . . . . .	212		
• Uconnect TOUCH™ SETTINGS . . . . .	212		
• Hard-Keys . . . . .	212		

**UNDERSTANDING YOUR INSTRUMENT PANEL**

• General Overview . . . . .	237	• Rear Blower Control . . . . .	246
• Climate Control Functions . . . . .	242	• Rear Temperature Control . . . . .	246
• Automatic Temperature Control (ATC) . . . . .	243	• Rear Mode Control . . . . .	247
• Rear Automatic Temperature Control (ATC) — If Equipped . . . . .	244	• Operating Tips . . . . .	247

UNDERSTANDING YOUR INSTRUMENT PANEL

**INSTRUMENT PANEL FEATURES**

art=040136140.tif NO TRANS

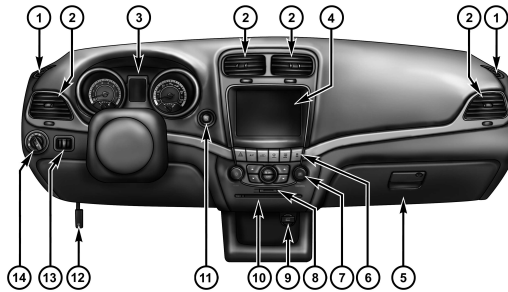

040136140

- 1 — Side Window Demist Outlet
- 2 — Air Outlet
- 3 — Instrument Cluster
- 4 — Uconnect Touch™ System
- 5 — Glove Compartment

- 6 — Switch Bank
- 7 — Uconnect Touch™ Hard Controls
- 8 — SD Memory Card Slot
- 9 — Power Outlet
- 10 — CD/DVD Slot

- 11 — Engine Start/Stop Button
- 12 — Hood Release Lever
- 13 — Dimmer Controls
- 14 — Headlight Switch

UNDERSTANDING YOUR INSTRUMENT PANEL

INSTRUMENT CLUSTER

art=040436362.tif NO TRANS

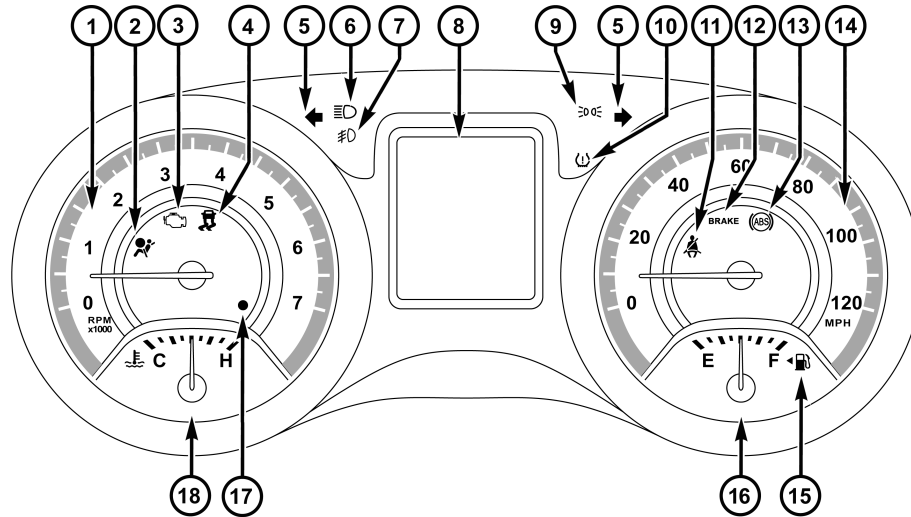



**UNDERSTANDING YOUR INSTRUMENT PANEL**

**INSTRUMENT CLUSTER DESCRIPTIONS**

**1. Tachometer**

The red segments indicate the maximum permissible engine revolutions per minute (RPM x 1000) for each gear range. Before reaching the red area, ease up on the accelerator.

**2. Airbag Warning Light**

art=022600747.tif NO TRANS



This light will turn on for four to eight seconds as a bulb check when the ignition switch is first turned to ON/RUN. If the light is either not on during starting, stays on, or turns on while driving, then have the system inspected at an authorized dealer as soon as possible. Refer to

“Occupant Restraints” in “Things To Know Before Starting Your Vehicle” for further information.

**3. Malfunction Indicator Light (MIL)**

art=040400383.tif NO TRANS



The Malfunction Indicator Light (MIL) is part of an onboard diagnostic system, called OBD, that monitors engine and automatic transmission control systems. The light will illuminate when the key is in the ON/RUN position, before engine start. If the bulb does not come on when turning the key from OFF to ON/RUN, have the condition checked promptly.

Certain conditions such as a loose or missing gas cap, poor fuel quality, etc., may illuminate the MIL after engine start. The vehicle should be serviced if the light stays on through several of your typical

driving cycles. In most situations, the vehicle will drive normally and will not require towing.

CAUTION!
<b>Prolonged driving with the MIL on could cause damage to the engine control system. It also could affect fuel economy and drivability. If the MIL is flashing, severe catalytic converter damage and power loss will soon occur. Immediate service is required.</b>

## UNDERSTANDING YOUR INSTRUMENT PANEL

### WARNING!

**A malfunctioning catalytic converter, as referenced above, can reach higher temperatures than in normal operating conditions. This can cause a fire if you drive slowly or park over flammable substances such as dry plants or wood or cardboard, etc. This could result in death or serious injury to the driver, occupants or others.**

#### 4. Electronic Stability Control (ESC) Activation/Malfunction Indicator Light — If Equipped

art=040453445.tif



NO TRANS  
The “ESC Activation/Malfunction Indicator Light” in the instrument cluster will come on when the ignition switch is turned to the ON/RUN

position. It should go out with the engine running. If the “ESC Activation/Malfunction Indicator Light” comes on continuously with the engine running, a malfunction has been detected in the ESC system. If this light remains on after several ignition cycles, and the vehicle has been driven several miles (kilometers) at speeds greater than 30 mph (48 km/h), see your authorized dealer as soon as possible to have the problem diagnosed and corrected.

#### NOTE:

- The “ESC Off Indicator Light” and the “ESC Activation/Malfunction Indicator Light” come on momentarily each time the ignition switch is turned to ON/RUN.
- Each time the ignition is turned to ON/RUN, the ESC system will be ON even if it was turned off previously.

- The ESC system will make buzzing or clicking sounds when it is active. This is normal; the sounds will stop when ESC becomes inactive following the maneuver that caused the ESC activation.

#### 5. Turn Signal Indicators

art=040407319.tif



NO TRANS  
The arrow will flash with the exterior turn signal when the turn signal lever is operated.

If the vehicle electronics sense that the vehicle has traveled about 1 mile (1.6 km) with the turn signals on, a continuous chime will sound to alert you to turn the signals off. If either indicator flashes at a rapid rate, check for a defective outside light bulb.

#### 6. High Beam Indicator

art=040480385.tif



NO TRANS  
This indicator shows that the high beam headlights are on. Push the

**UNDERSTANDING YOUR INSTRUMENT PANEL**

multifunction lever forward to switch the headlights to high beam, and pull toward yourself (normal position) to return to low beam.

**7. Front Fog Light Indicator — If**

**Equipped**  
art=031400346.tif NO TRANS



This indicator will illuminate when the front fog lights are on.

**8. Electronic Vehicle Information Center (EVIC) Display**

**Odometer**

The odometer display shows the total distance the vehicle has been driven.

Regulations require that upon transfer of vehicle ownership, the seller certify to the purchaser the correct mileage that the vehicle has been driven. If your odometer needs to be repaired or serviced, the

repair technician should leave the odometer reading the same as it was before the repair or service. If s/he cannot do so, then the odometer must be set at zero, and a sticker must be placed in the door jamb stating what the mileage was before the repair or service. It is a good idea for you to make a record of the odometer reading before the repair/service, so that you can be sure that it is properly reset, or that the door jamb sticker is accurate if the odometer must be reset at zero.

**Electronic Vehicle Information Center (EVIC) Display**

The Electronic Vehicle Information Center (EVIC) features a driver-interactive display that is located in the instrument cluster. For further information refer to "Electronic Vehicle Information Center (EVIC)".

**9. Position Light Indicator — If Equipped**

art=040408005.tif NO TRANS



This indicator will illuminate when the park lights or headlights are turned on.

**10. Tire Pressure Monitoring Telltale Light — If Equipped**

art=040400797.tif NO TRANS



Each tire, including the spare (if provided), should be checked monthly, when cold and inflated to the inflation pressure recommended by the

vehicle manufacturer on the vehicle placard or tire inflation pressure label. (If your vehicle has tires of a different size than the size indicated on the vehicle placard or tire inflation pressure label, you should determine the proper tire inflation pressure for those tires.)

## UNDERSTANDING YOUR INSTRUMENT PANEL

As an added safety feature, your vehicle has been equipped with a Tire Pressure Monitoring System (TPMS) that illuminates a low tire pressure telltale when one or more of your tires is significantly under-inflated. Accordingly, when the low tire pressure telltale illuminates, you should stop and check your tires as soon as possible, and inflate them to the proper pressure. Driving on a significantly under-inflated tire causes the tire to overheat and can lead to tire failure. Under-inflation also reduces fuel efficiency and tire tread life, and may affect the vehicle's handling and stopping ability.

Please note that the TPMS is not a substitute for proper tire maintenance, and it is the driver's responsibility to maintain correct tire pressure, even if under-inflation

has not reached the level to trigger illumination of the TPMS low tire pressure telltale.

Your vehicle has also been equipped with a TPMS malfunction indicator to indicate when the system is not operating properly. The TPMS malfunction indicator is combined with the low tire pressure telltale. When the system detects a malfunction, the telltale will flash for approximately one minute and then remain continuously illuminated. This sequence will continue upon subsequent vehicle start-ups as long as the malfunction exists. When the malfunction indicator is illuminated, the system may not be able to detect or signal low tire pressure as intended. TPMS malfunctions may occur for a variety of reasons, including the installation of replacement or alternate tires or wheels on the

vehicle that prevent the TPMS from functioning properly. Always check the TPMS malfunction telltale after replacing one or more tires or wheels on your vehicle, to ensure that the replacement or alternate tires and wheels allow the TPMS to continue to function properly.

**UNDERSTANDING YOUR INSTRUMENT PANEL**

**CAUTION!**

**The TPMS has been optimized for the original equipment tires and wheels. TPMS pressures and warning have been established for the tire size equipped on your vehicle. Undesirable system operation or sensor damage may result when using replacement equipment that is not of the same size, type, and/or style. Aftermarket wheels can cause sensor damage. Do not use tire sealant from a can, or balance beads if your vehicle is equipped with a TPMS, as damage to the sensors may result.**

**11 Seat Belt Reminder Light**



When the ignition switch is first turned to ON/RUN, this light will turn on for four to eight seconds as

a bulb check. During the bulb check, if the driver or front passenger's seat belt is unbuckled, a chime will sound. After the bulb check or when driving, if the driver's seat belt remains unbuckled, the Seat Belt Reminder Light will illuminate and the chime will sound. Refer to "Occupant Restraints" in "Things To Know Before Starting Your Vehicle" for further information.

**12 Brake Warning Light**

**BRAKE**

This light monitors various brake functions, including brake fluid level and parking brake application. If the brake light turns on, it may indicate that the parking brake is applied, that the brake fluid level is low, or that there is a problem with the anti-lock brake system reservoir.

If the light remains on when the parking brake has been disengaged, and the fluid level is at the full mark on the master cylinder reservoir, it indicates a possible brake hydraulic system malfunction or that a problem with the Brake Booster has been detected by the Anti-Lock Brake System (ABS) / Electronic Stability Program (ESP) system. In this case, the light will remain on until the condition has been corrected. If the problem is related to the brake booster, the ABS pump will run when applying the brake and a brake pedal pulsation may be felt during each stop.

The dual brake system provides a reserve braking capacity in the event of a failure to a portion of the hydraulic system. A leak in either half of the dual brake system is indicated by the Brake Warning Light,

## UNDERSTANDING YOUR INSTRUMENT PANEL

which will turn on when the brake fluid level in the master cylinder has dropped below a specified level.

The light will remain on until the cause is corrected.

**NOTE:** *The light may flash momentarily during sharp cornering maneuvers, which change fluid level conditions. The vehicle should have service performed, and the brake fluid level checked.*

If brake failure is indicated, immediate repair is necessary.

### WARNING!

**Driving a vehicle with the red brake light on is dangerous. Part of the brake system may have failed. It will take longer to stop the vehicle. You could have a collision. Have the vehicle checked immediately.**

Vehicles equipped with the Anti-Lock Brake System (ABS), are also equipped with Electronic Brake Force Distribution (EBD). In the event of an EBD failure, the Brake Warning Light will turn on along with the ABS Light. Immediate repair to the ABS system is required.

Operation of the Brake Warning Light can be checked by turning the ignition switch from the OFF position to the ON/RUN position. The light should illuminate for

approximately two seconds. The light should then turn off unless the parking brake is applied or a brake fault is detected. If the light does not illuminate, have the light inspected by an authorized dealer.

The light also will turn on when the parking brake is applied with the ignition switch in the ON/RUN position.

**NOTE:** *This light shows only that the parking brake is applied. It does not show the degree of brake application.*

### 13. Anti-Lock Brake (ABS) Light

This light monitors the Anti-Lock Brake System (ABS). The light will turn on when the ignition switch is turned to the ON/RUN position and may stay on for as long as four seconds.



**UNDERSTANDING YOUR INSTRUMENT PANEL**

If the ABS light remains on or turns on while driving, it indicates that the Anti-Lock portion of the brake system is not functioning and that service is required. However, the conventional brake system will continue to operate normally if the BRAKE warning light is not on.

If the ABS light is on, the brake system should be serviced as soon as possible to restore the benefits of Anti-Lock brakes. If the ABS light does not turn on when the ignition switch is turned to the ON/RUN position, have the light inspected by an authorized dealer.

**14. Speedometer**

Indicates vehicle speed.

**15. Fuel Door Reminder**



The arrow in this symbol is a reminder that the Fuel Filler Door is located on the left side of the vehicle.

**16. Fuel Gauge**

The pointer shows the level of fuel in the fuel tank when the ignition switch is in the ON/RUN position.

**17. Vehicle Security Light — If Equipped**



art=040402339.tif

NO TRANS

This light will flash at a fast rate for approximately 15 seconds, when the vehicle security alarm is arming, and then will flash slowly until the vehicle is

disarmed.

**18. Temperature Gauge**

The temperature gauge shows engine coolant temperature. Any reading within the normal range indicates that the engine cooling system is operating satisfactorily.

The gauge pointer will likely indicate a higher temperature when driving in hot weather, up mountain grades, or when towing a trailer. It should not be allowed to exceed the upper limits of the normal operating range.

## UNDERSTANDING YOUR INSTRUMENT PANEL

### CAUTION!

Driving with a hot engine cooling system could damage your vehicle. If the temperature gauge reads “H” pull over and stop the vehicle. Idle the vehicle with the air conditioner turned off until the pointer drops back into the normal range. If the pointer remains on the “H” and you hear continuous chimes, turn the engine off immediately, and call an authorized dealership for service.

### WARNING!

A hot engine cooling system is dangerous. You or others could be badly burned by steam or boiling coolant. You may want to call an authorized dealership for service if your vehicle overheats. If you decide to look under the hood yourself, see “Maintaining Your Vehicle”. Follow the warnings under the Cooling System Pressure Cap paragraph.

## ELECTRONIC VEHICLE INFORMATION CENTER (EVIC)

The Electronic Vehicle Information Center (EVIC) features a driver-interactive display that is located in the instrument cluster.

art=041035317.tif NO TRANS

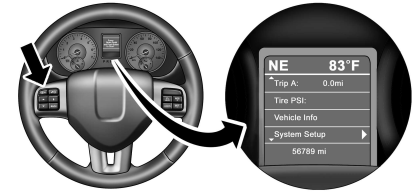

041035317

### Electronic Vehicle Information Center (EVIC)

This system allows the driver to select a variety of useful information by pressing the switches mounted on the steering wheel. The EVIC consists of the following:

- Radio Info
- Fuel Economy
- Vehicle Speed
- Trip Info



## UNDERSTANDING YOUR INSTRUMENT PANEL

- Tire Pressure
- Vehicle Info Messages (Stored Warning Messages)
- Turn Menu OFF

The system allows the driver to select information by pressing the following buttons mounted on the steering wheel.

art=040909599.tif NO TRANS



EVIC Steering Wheel Buttons

### UP Button

art=041005967.tif

NO TRANS



Press and release the UP button to scroll upward through the main menus (Fuel Economy, Vehicle Info, Tire PSI, Cruise, Messages, Units, System Setup) and sub menus.

### DOWN Button

art=041005969.tif

NO TRANS



Press and release the DOWN button to scroll downward through the main menus and sub menus.

### SELECT Button

art=041009868.tif

NO TRANS



Press and release the SELECT button for access to main menus, sub menus or to select a personal setting in the setup

menu. Press and hold the SELECT button for two seconds to reset features.

### BACK Button

art=041009870.tif

NO TRANS

## BACK

Press the BACK button to scroll back to a previous menu or sub menu.

### Electronic Vehicle Information Center (EVIC) Displays

When the appropriate conditions exist, the EVIC displays the following messages:

- Turn Signal On (with a continuous warning chime if the vehicle is driven more than 1 mile [1.6 km] with either turn signal on)
- Left Front Turn Signal Light Out (with a single chime)

## UNDERSTANDING YOUR INSTRUMENT PANEL

- Left Rear Turn Signal Light Out (with a single chime)
- Right Front Turn Signal Light Out (with a single chime)
- Right Rear Turn Signal Light Out (with a single chime)
- RKE Battery Low (with a single chime)
- Personal Settings Not Available – Vehicle Not in PARK
- Left/Right Front Door Ajar (one or more, with a single chime if speed is above 1 mph [1.6 km/h])
- Left/Right Rear Door Ajar (one or more, with a single chime if speed is above 1 mph [1.6 km/h])
- Door(s) Ajar (with a single chime if vehicle is in motion)
- Liftgate Ajar (with a single chime)
- Low Washer Fluid (with a single chime)
- Low Tire Pressure
- Service Tire Pressure
- ECO (Fuel Saver Indicator) — if equipped
- Channel # Transmit
- Channel # Training
- Channel # Trained
- Clearing Channels
- Channels Cleared
- Did Not Train
- Check Gascap (refer to “Adding Fuel” in “Starting And Operating”)

- Oil Change Required (with a single chime)

### EVIC White Telltale Lights

This area will show reconfigurable white caution telltales. These telltales include:

- **Shift Lever Status**

The shift lever status “P,R,N,D,L,5,4,3,2,1” are displayed indicating the shift lever position. Telltales “5,4,3,2,1” indicate the Electronic Range Select (ERS) feature has been engaged and the gear selected is displayed. For further information on ERS, refer to “Starting And Operating”

- **Electronic Speed Control ON**

This light will turn on when the electronic speed control is ON. For further information, refer to “Electronic Speed Control” in



art=041033482.tif NO TRANS

## UNDERSTANDING YOUR INSTRUMENT PANEL

“Understanding The Features Of Your Vehicle”.

### • **Electronic Speed Control SET**

art=032100155.tif

NO TRANS



This light will turn on when the electronic speed control is SET. For further information, refer to “Electronic Speed Control” in “Understanding The

Features Of Your Vehicle”.

### • **EVIC Amber Telltale Lights**

This area will show reconfigurable amber caution telltales. These telltales include:

#### • **Low Fuel Light**

art=040400374.tif

NO TRANS



When the fuel level reaches approximately 3.0 gal (11.0 L) this light will turn on, and remain on until fuel is added.

### • **Loose Gascap Indicator**

art=041007754.tif

NO TRANS



If the vehicle diagnostic system determines that the fuel filler cap is loose, improperly installed, or damaged, a loose gascap indicator will display in the telltale display area. Tighten the fuel filler cap properly and press the SELECT button to turn off the message. If the problem continues, the message will appear the next time the vehicle is started.

A loose, improperly installed, or damaged fuel filler cap may also turn on the Malfunction Indicator Light (MIL).

### • **Windshield Washer Fluid Low Indicator**

art=040437642.tif

NO TRANS



This light will turn on to indicate the windshield washer fluid is low.

### • **EVIC Red Telltale Lights**

This area will show reconfigurable red telltales. These telltales include:

#### • **Door Ajar**

art=041009896.tif

NO TRANS



This light will turn on to indicate that one or more door may be ajar.

#### • **Oil Pressure Warning Light**

art=040400378.tif

NO TRANS



This light indicates low engine oil pressure. The light should turn on momentarily when the engine is started. If the light turns on while driving, stop the vehicle and shut off the engine as soon as possible. A chime will sound for four minutes when this light turns on.

Do not operate the vehicle until the cause is corrected. This light does not show how

## UNDERSTANDING YOUR INSTRUMENT PANEL

much oil is in the engine. The engine oil level must be checked under the hood.

### • **Charging System Light**



This light shows the status of the electrical charging system. The light should come on when the ignition switch is first turned ON and remain on briefly as a bulb check. If the light stays on or comes on while driving, turn off some of the vehicle's non-essential electrical devices or increase engine speed (if at idle). If the charging system light remains on, it means that the vehicle is experiencing a problem with the charging system. Obtain SERVICE IMMEDIATELY. See an authorized dealer.

If jump starting is required, refer to "Jump Starting Procedures" in "What To Do In Emergencies".

### • **Electronic Throttle Control (ETC) Light**

art=040400380.tif



NO TRANS  
This light informs you of a problem with the Electronic Throttle Control (ETC) system. The light will come on when the ignition is first turned ON and remain on briefly as a bulb check. If the light does not come on during starting, have the system checked by an authorized dealer.

If a problem is detected, the light will come on while the engine is running. Cycle the ignition key when the vehicle has completely stopped and the shift lever is placed in the PARK position. The light should turn off.

If the light remains lit with the engine running, your vehicle will usually be drivable. However, see an authorized dealer

for service as soon as possible. If the light is flashing when the engine is running, immediate service is required and you may experience reduced performance, an elevated/rough idle or engine stall and your vehicle may require towing.

### • **Engine Temperature Warning Light**



art=040400375.tif NO TRANS  
This light warns of an overheated engine condition. As temperatures rise and the gauge approaches **H**, this indicator will illuminate and a single chime will sound after reaching a set threshold. Further overheating will cause the temperature gauge to pass **H**, the indicator will continuously flash and a continuous chime will occur until the engine is allowed to cool.

If the light turns on while driving, safely pull over and stop the vehicle. If the A/C system is on, turn it off. Also, shift the

## UNDERSTANDING YOUR INSTRUMENT PANEL

transmission into NEUTRAL and idle the vehicle. If the temperature reading does not return to normal, turn the engine off immediately and call for service. Refer to "If Your Engine Overheats" in "What To Do In Emergencies" for more information.

- **Transmission Temperature Warning Light**

art=040400794.tif

NO TRANS



This light indicates that the transmission fluid temperature is running hot. This may occur with severe usage, such as trailer towing. If this light turns on, safely pull over and stop the vehicle. Then, shift the transmission into NEUTRAL and run the engine at idle or faster until the light turns off.

### CAUTION!

**Continuous driving with the Transmission Temperature Warning Light illuminated will eventually cause severe transmission damage or transmission failure.**

### WARNING!

**If the Transmission Temperature Warning Light is illuminated and you continue operating the vehicle, in some circumstances you could cause the fluid to boil over, come in contact with hot engine or exhaust components and cause a fire.**

### Oil Change Required

Your vehicle is equipped with an engine oil change indicator system. The "Oil Change

Required" message will flash in the EVIC display for approximately 10 seconds after a single chime has sounded to indicate the next scheduled oil change interval. The engine oil change indicator system is duty cycle based, which means the engine oil change interval may fluctuate dependent upon your personal driving style.

Unless reset, this message will continue to display each time you turn the ignition switch to the ON position. To turn off the message temporarily, press and release the MENU button. To reset the oil change indicator system (after performing the scheduled maintenance) perform the following procedure:

1. Cycle the ignition to the ON/RUN position. (Do not start the engine).

## UNDERSTANDING YOUR INSTRUMENT PANEL

2. Fully depress the accelerator pedal slowly three times within 10 seconds.
3. Turn the ignition switch to the OFF position.

**NOTE:** *If the indicator message illuminates when you start the vehicle, the oil change indicator system did not reset. If necessary, repeat this procedure.*

### Fuel Economy

Press and release the UP or DOWN button until "Fuel Economy" displays highlighted in the EVIC and press the SELECT button. Press and release the UP/DOWN buttons until one of the following Fuel Economy functions displays in the EVIC:

- Average Fuel Economy/Fuel Saver Mode
- Distance To Empty (DTE)

- Miles Per Gallon (MPG)

Press the UP/DOWN buttons to cycle through all the Trip Computer functions.

The Trip Functions mode displays the following information:

### Average Fuel Economy / Fuel Saver Mode — If Equipped

Shows the average fuel economy since the last reset. When the fuel economy is reset, the display will read "RESET" or show dashes for two seconds. Then, the history information will be erased, and the averaging will continue from the last fuel average reading before the reset.

The FUEL SAVER MODE message will display above the average fuel economy in the EVIC display. This message will appear whenever MDS (if equipped) al-

lows the engine to operate on four cylinders, or if you are driving in a fuel efficient manner.

art=041009379.tif NO TRANS

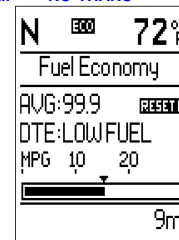

041009379

### Fuel Saver Mode — On

This feature allows you to monitor when you are driving in a fuel efficient manner, and it can be used to modify driving habits in order to increase fuel economy.

## UNDERSTANDING YOUR INSTRUMENT PANEL

### Distance To Empty (DTE)

Shows the estimated distance that can be traveled with the fuel remaining in the tank. This estimated distance is determined by a weighted average of the instantaneous and average fuel economy, according to the current fuel tank level. DTE cannot be reset through the SELECT button.

**NOTE:** *Significant changes in driving style or vehicle loading will greatly affect the actual drivable distance of the vehicle, regardless of the DTE displayed value.*

When the DTE value is less than 30 miles (48 km) estimated driving distance, the DTE display will change to a "LOW FUEL" message. This display will continue until the vehicle runs out of fuel. Adding a significant amount of fuel to the vehicle will turn off the "LOW FUEL" message and a new DTE value will display.

### Vehicle Speed

Press and release the UP or DOWN button until "Vehicle Speed" displays highlighted in the EVIC and press the SELECT button. Press the SELECT button to display the current speed in mph or km/h. Pressing the SELECT button a second time will toggle the unit of measure between mph or km/h

**NOTE:** *Changing the unit of measure in the Vehicle Speed menu will not change the unit of measure in the EVIC.*

### Trip Info

Press and release the UP or DOWN button until "Trip Info" displays highlighted in the EVIC and press the SELECT button. Press and release the UP/DOWN buttons until one of the following Trip functions displays in the EVIC:

- Trip A
- Trip B
- Elapsed Time

Press the UP/DOWN buttons to cycle through all the Trip Computer functions.

The Trip Functions mode displays the following information:

### Trip A

Shows the total distance traveled for Trip A since the last reset.

### Trip B

Shows the total distance traveled for Trip B since the last reset.

### Elapsed Time

Shows the total elapsed time of travel since the last reset when the ignition is in

## UNDERSTANDING YOUR INSTRUMENT PANEL

the ACC position. Elapsed time will increment when the ignition is in the ON/RUN position.

### To Reset The Display

Reset will only occur while a resettable function is being displayed. Press and release the SELECT button once to clear the resettable function being displayed. To reset all resettable functions, press and hold the SELECT button for two seconds. Current display will reset along with other functions

### Units

Press and release the UP or DOWN button until "Units" displays highlighted in the EVIC and press the SELECT button. The EVIC, odometer, and navigation system (if equipped) can be changed between English and Metric units of measure. To make your selection, scroll up or down until the

preferred setting is highlighted, then press and release the SELECT button until a check-mark appears next to the setting, showing that setting has been selected.

### Vehicle Info (Customer Information Features)

Press and release the UP or DOWN button until "Vehicle Info" displays in the EVIC and press the SELECT button. Press the UP and DOWN button to scroll through the available information displays, then press SELECT to display anyone of the following choices.

- **Coolant Temp**

Displays the actual coolant temperature.

- **Oil Temperature**

Displays the actual oil temperature.

- **Oil Pressure**

Displays the actual oil pressure.

- **Trans Temperature**

Displays the actual transmission temperature.

- **Engine Hours**

Displays the hours of engine operation.

## Uconnect TOUCH™ SETTINGS

The Uconnect Touch™ system uses a combination of soft and hard keys located on the center of the instrument panel that allows you to access and change the customer programmable features.

### Hard-Keys

Hard-keys are located on the left and right side of the Uconnect Touch™ 4.3 display.



**UNDERSTANDING YOUR INSTRUMENT PANEL**

**Soft-Keys**

Soft-keys are accessible on the Uconnect Touch™ display.

**Uconnect Touch™ 4.3 Settings — Customer Programmable Features**

In this mode the Uconnect Touch™ system allows you to access programmable features that may be equipped such as Display, Clock, Safety/Assistance, Lights, Doors & Locks, Heated Seats, Engine Off Operation, Compass Settings, Audio, Phone/Bluetooth and SIRIUS Setup through hard-keys and soft-keys.

**NOTE:** Only one touchscreen area may be selected at a time.

art=044336083.tif NO TRANS



044336083

**1 — Uconnect Touch™ 4.3 Settings Hard-key**

Press the "Settings" hard-key to access the Settings screen, use the Page Up/Down soft-keys to scroll through the following settings. Touch the desired setting soft key to change the setting using the description shown on the following pages for each setting

art=044435867.tif NO TRANS



044435867

**Uconnect Touch™ 4.3 Soft-keys**

**Display**

• **Brightness**

Press the Brightness soft-key to change this display. When in this display you may select display brightness with the headlights on and the headlights off. Adjust the brightness with the + and – setting soft-keys or by selecting any point on the scale in between the + and – soft-keys followed by pressing the arrow back soft-key.

## UNDERSTANDING YOUR INSTRUMENT PANEL

- **Mode**

Press the Mode soft-key to change this display. When in this display you may select one of the auto display settings. To change Mode status press and release the Day, Night or Auto soft-key followed by pressing the arrow back soft-key.

- **Language**

Press the Language soft-key to change this display. When in this display you may select one of three languages for all display nomenclature, including the trip functions and the navigation system (if equipped). Press the English, French (Français), Spanish (Español) button to select the language preferred followed by pressing the arrow back soft-key. Then, as you continue, the information will display in the selected language.

- **Units**

Press the Units soft-key to change this display. When in this display you may select to have the EVIC, odometer, and navigation system (if equipped) changed between US and Metric units of measure. Press US or Metric followed by pressing the arrow back soft-key. Then, as you continue, the information will display in the selected units of measure.

- **Voice Response**

Press the Voice Response soft-key to change this display. When in this display you may change the Voice Response Length settings. To change the Voice Response Length press and release the Brief or Long soft-key followed by pressing the arrow back soft-key.

- **Touch Screen Beep**

Press the Touch Screen Beep soft-key to change this display. When in this display you may turn on or shut off the sound heard when a touch screen button (soft-key) is pressed. To change the Touch Screen Beep setting press and release the On or Off soft-key followed by pressing the arrow back soft-key.

- **Fuel Saver Display**

Press the Fuel Saver Display soft-key to change this display. The “ECO” message is located in the instrument cluster display, this message can be turned on or off. To make your selection, press the Fuel Saver Display soft-key, select On or Off followed by pressing the arrow back soft-key.

---

## UNDERSTANDING YOUR INSTRUMENT PANEL

### Clock

- **Set Time**

Press the Set Time soft-key to change this display. When in this display you may select the time display settings. To make your selection, press the Set Time soft-key, adjust the hours and minutes using the up and down soft-keys, select AM or PM, select 12 hr or 24 hr followed by pressing the arrow back soft-key when all selections are complete.

- **Show Time Status**

Press the Show Time Status soft-key to change this display. When in this display you may turn on or shut off the digital clock in the status bar. To change the Show Time Status setting press and release the On or Off soft-key followed by pressing the arrow back soft-key.

- **Sync Time**

Press the Sync Time soft-key to change this display. When in this display you may automatically have the radio set the time. To change the Sync Time setting press and release the On or Off soft-key followed by pressing the arrow back soft-key.

### Safety / Assistance

- **Front Collision Warning**

Press the Front Collision Warning soft-key to change this display. The Front Collision Warning (FCW) feature can be set to Far, set to Near or turned Off. The default status of FCW is the Far setting. This means the system will warn you of a possible collision with the vehicle in front of you when you are farther away. This gives you the most reaction time. To change the setting for more dynamic driving select the Near setting. This warns you

of a possible collision with the vehicle in front of you when you are much closer. This allows for a more dynamic driving experience. To change FCW status press and release the Off, Near or Far button followed by pressing the arrow back soft-key.

For further information, refer to "Adaptive Cruise Control (ACC)" in "Understanding The Features Of Your Vehicle".

- **Park Assist**

Press the Park Assist soft-key to change this display. The Rear Park Assist system will scan for objects behind the vehicle when the transmission shift lever is in REVERSE and the vehicle speed is less than 11 mph (18 km/h). The system can be enabled with Sound Only, Sound and Display, or turned OFF. To change the Park Assist status press and release the Off,

## UNDERSTANDING YOUR INSTRUMENT PANEL

Sound Only or Sounds and Display button followed by pressing the arrow back soft-key. Refer to "Rear Park Assist System" in "Understanding The Features Of Your Vehicle" for system function and operating information.

- **Tilt Mirrors in Reverse**

Press the Tilt Mirrors in Reverse soft-key to change this display. When this feature is selected, the outside rearview mirrors will tilt downward when the ignition is in the RUN position and the transmission shift lever is in the REVERSE position. The mirrors will move back to their previous position when the transmission is shifted out of REVERSE. To make your selection, press the Tilt Mirrors in Reverse soft-key, select On or Off followed by pressing the arrow back soft-key.

- **Blind Spot Alert**

Press the Blind Spot Alert soft-key to change this display. When this feature is selected the Blind Spot Alert feature can be set to Off, Lights or Lights and Chime. The Blind Spot Alert feature can be activated in "Lights" mode, when this mode is selected the Blind Spot Monitor (BSM) system is activated and will only show a visual alert in the outside mirrors. When "Lights & Chime" mode is activated the Blind Spot Monitor (BSM) will show a visual alert in the outside mirrors as well as an audible alert when the turn signal is on. When "Off" is selected the Blind Spot Monitor (BSM) system is deactivated. To change the Blind Spot Alert status press the Off, Lights or Lights & Chime soft-key followed by pressing the arrow back soft-key.

**NOTE:** *If your vehicle has experienced any damage in the area where the sensor is located, even if the fascia is not damaged, the sensor may have become misaligned. Take your vehicle to an authorized dealer to verify sensor alignment. Having a sensor that is misaligned will result in the BSM not operating to specification.*

- **Rain Sensing**

Press the Rain Sensing soft-key to change this display. When this feature is selected, the system will automatically activate the windshield wipers if it senses moisture on the windshield. To make your selection, press the Rain Sensing soft-key, select On or Off followed by pressing the arrow back soft-key.

---

## UNDERSTANDING YOUR INSTRUMENT PANEL

- **Hill Start Assist**

Press the Hill Start Assist soft-key to change this display. When this feature is selected, the Hill Start Assist (HSA) system is active. Refer to “Electronic Brake Control System” in “Starting And Operating” for system function and operating information. To make your selection, press the Hill Start Assist soft-key, select On or Off followed by pressing the arrow back soft-key.

### Lights

- **Headlight Off Delay**

Press the Headlight Off Delay soft-key to change this display. When this feature is selected, the driver can choose to have the headlights remain on for 0, 30, 60, or 90 seconds when exiting the vehicle. To change the Headlight Off Delay status

press the 0, 30, 60 or 90 soft-key followed by pressing the arrow back soft-key.

- **Illuminated Approach**

Press the Illuminated Approach soft-key to change this display. When this feature is selected, the headlights will activate and remain on for 0, 30, 60, or 90 seconds when the doors are unlocked with the RKE transmitter. To change the Illuminated Approach status press the 0, 30, 60 or 90 soft-key followed by pressing the arrow back soft-key.

- **Headlights with Wipers**

Press the Headlights with Wipers soft-key to change this display. When this feature is selected, and the headlight switch is in the AUTO position, the headlights will turn on approximately 10 seconds after the wipers are turned on. The headlights will also turn off when the wipers are turned off if they

were turned on by this feature. To make your selection, press the Headlights with Wipers soft-key, select On or Off followed by pressing the arrow back soft-key.

- **Auto High Beams**

Press the Auto High Beams soft-key to change this display. When this feature is selected, the high beam headlights will deactivate automatically under certain conditions. To make your selection, press the Auto High Beams soft-key, select ON or OFF followed by pressing the arrow back soft-key. Refer to “Lights/SmartBeam™ — If Equipped” in “Understanding The Features Of Your Vehicle” for further information.

- **Daytime Running Lights**

Press the Daytime Running Lights soft-key to change this display. When this feature is

## UNDERSTANDING YOUR INSTRUMENT PANEL

selected, the headlights will turn on whenever the engine is running. To make your selection, press the Daytime Running Lights soft-key, select ON or OFF followed by pressing the arrow back soft-key.

- **Steering Directed Lights**

Press the Steering Directed Lights soft-key to change this display. When this feature is selected, the headlights turn relative to a change in direction of the steering wheel. To make your selection, press the Steering Directed Lights soft-key, select ON or OFF followed by pressing the arrow back soft-key.

- **Flash Headlights with Lock**

Press the Flash Headlights with Lock soft-key to change this display. When this feature is selected, the front and rear turn signals will flash when the doors are locked or unlocked with the RKE transmit-

ter. This feature may be selected with or without the sound horn on lock feature selected. To make your selection, press the Flash Headlights with Lock soft-key, select On or Off followed by pressing the arrow back soft-key.

### Doors & Locks

- **Auto Unlock on Exit**

Press the Auto Unlock on Exit soft-key to change this display. When this feature is selected, all doors will unlock when the vehicle is stopped and the transmission is in the PARK or NEUTRAL position and the driver's door is opened. To make your selection, press the Auto Unlock on Exit soft-key, select On or Off followed by pressing the arrow back soft-key.

- **Flash Lights with Lock**

Press the Flash Lights with Lock soft-key to change this display. When this feature is selected, the front and rear turn signals will flash when the doors are locked or unlocked with the RKE transmitter. To make your selection, press the Flash Lights with Lock soft-key, select On or Off followed by pressing the arrow back soft-key.

- **Sound Horn with Remote Start**

Press the Sound Horn with Remote Start soft-key to change this display. When this feature is selected, the horn will sound when the remote start is activated. To make your selection, press the Sound Horn with Remote Start soft-key, select On or Off followed by pressing the arrow back soft-key.

---

## UNDERSTANDING YOUR INSTRUMENT PANEL

- **Sounds Horn with Lock**

Press the Sounds Horn with Lock soft-key to change this display. When this feature is selected, the horn will chirp when the doors are locked or unlocked with the RKE transmitter. To make your selection, press the Sounds Horn with Lock soft-key, select On or Off followed by pressing the arrow back soft-key.

- **Remote Door Unlock Order**

Press the Remote Door Unlock Order soft-key to change this display. When **Unlock Driver Door Only On 1st Press** is selected, only the driver's door will unlock on the first press of the RKE transmitter UNLOCK button. When Driver Door 1st Press is selected, you must press the RKE transmitter UNLOCK button twice to unlock the passenger's doors. When **Unlock All Doors On 1st Press** is selected, all of the

doors will unlock on the first press of the RKE transmitter UNLOCK button.

**NOTE:** *If the vehicle is equipped with Keyless Enter-N-Go (Passive Entry) and the EVIC is programmed to Unlock All Doors 1st Press, all doors will unlock no matter which Passive Entry equipped door handle is grasped. If Driver Door 1st Press is programmed, only the driver's door will unlock when the driver's door is grasped. With Passive Entry, if Driver Door 1st Press is programmed touching the handle more than once will only result in the driver's door opening. If driver door first is selected, once the driver door is opened, the interior door lock/unlock switch can be used to unlock all doors (or use RKE transmitter).*

- **Memory Linked to FOB**

Press the Memory Linked to FOB soft-key to change this display. This feature provides automatic driver seat positioning to enhance driver mobility when entering and exiting the vehicle, driver 1 and driver 2 last mode, settings and presets. To make your selection, press the Memory Linked to FOB soft-key, select ON or OFF followed by pressing the arrow back soft-key.

**NOTE:** *The seat will return to the memorized seat location (if Recall Memory with Remote Key Unlock is set to ON) when the RKE transmitter is used to unlock the door. Refer to "Driver Memory Seat" in "Understanding The Features Of Your Vehicle" for further information.*

## UNDERSTANDING YOUR INSTRUMENT PANEL

- **Passive Entry (Keyless Enter-N-Go)**

Press the Passive Entry soft-key to change this display. This feature allows you to lock and unlock the vehicle's door(s) without having to press the RKE transmitter lock or unlock buttons. To make your selection, press the Passive Entry soft-key, select ON or OFF followed by pressing the arrow back soft-key. Refer to "Keyless Enter-N-Go" in "Things To Know Before Starting Your Vehicle".

### Heated Seats

- **Auto Heated Seats**

Press the Auto Heated Seats soft-key to change this display. When this feature is selected the driver's heated seat will automatically turn on when temperatures are below 40° F (4.4° C). To make your selection, press the Auto Heated Seats soft-key,

select On or Off followed by pressing the arrow back soft-key.

### Engine Off Options

- **Easy Exit Seats**

Press the Easy Exit Seats soft-key to change this display. This feature provides automatic driver seat positioning to enhance driver mobility when entering and exiting the vehicle. To make your selection, press the Easy Exit Seats soft-key, select On or Off followed by pressing the arrow back soft-key.

**NOTE:** *The seat will return to the memorized seat location (if Recall Memory with Remote Key Unlock is set to ON) when the RKE transmitter is used to unlock the door. Refer to "Driver Memory Seat" in "Understanding The Features Of Your Vehicle" for further information.*

- **Headlight Off Delay**

Press the Headlight Off Delay soft-key to change this display. When this feature is selected, the driver can choose to have the headlights remain on for 0, 30, 60, or 90 seconds when exiting the vehicle. To change the Headlight Off Delay status press the 0, 30, 60 or 90 soft-key followed by pressing the arrow back soft-key.

- **Engine Off Power Delay**

Press the Engine Off Power Delay soft-key to change this display. When this feature is selected, the power window switches, radio, Uconnect™ phone system (if equipped), DVD video system (if equipped), power sunroof (if equipped), and power outlets will remain active for up to 10 minutes after the ignition is cycled to OFF. Opening either front vehicle door will cancel this feature. To change the Engine



## UNDERSTANDING YOUR INSTRUMENT PANEL

Off Power Delay status press the 0 seconds, 45 seconds, 5 minutes or 10 minutes soft-key followed by pressing the arrow back soft-key.

### Compass Settings

#### • Variance

Press the Variance soft-key to change this display. Compass Variance is the difference between Magnetic North and Geographic North. To compensate for the differences the variance should be set for the zone where the vehicle is driven, per the zone map. Once properly set, the compass will automatically compensate for the differences, and provide the most accurate compass heading. For the most accurate compass performance, the compass must be set using the following steps.

**NOTE:** Keep magnetic materials away from the top of the instrument panel, such as iPod's, Mobile Phones, Laptops and Radar Detectors. This is where the compass module is located, and it can cause interference with the compass sensor, and it may give false readings.

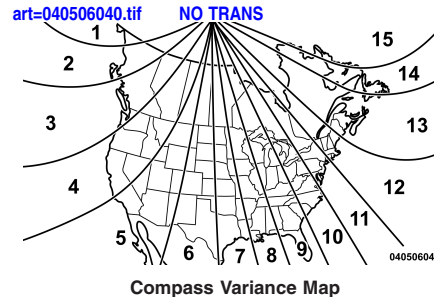

Compass Variance Map

#### • Calibration

Press the Calibration key to change this setting. This compass is self-calibrating, which eliminates the need to manually reset the compass. When the vehicle is new, the compass may appear erratic and the EVIC will display CAL until the compass is calibrated. You may also calibrate the compass by pressing the ON soft-key and completing one or more 360-degree turns (in an area free from large metal or metallic objects) until the CAL indicator displayed in the EVIC turns off. The compass will now function normally.

**NOTE:** A good calibration requires a level surface and an environment free from large metallic objects such as buildings, bridges, underground cables, railroad tracks, etc.

## UNDERSTANDING YOUR INSTRUMENT PANEL

### Audio

- **Equalizer**

Press the Equalizer soft-key to change this display. When in this display you may adjust the Bass, Mid and Treble settings. Adjust the settings with the + and – setting soft-keys or by selecting any point on the scale in between the + and – soft-keys followed by pressing the arrow back soft-key.

**NOTE:** *Bass/mid/treble allow the you to simply slide your finger up/down to change the setting as well as press directly on the desired setting.*

- **Balance / Fade**

Press the Balance / Fade soft-key to change this display. When in this display you may adjust the Balance and Fade settings.

- **Speed Adjusted Volume**

Press the Speed Adjusted Volume soft-key to change this display. Decreases volume relative to vehicle speed. To change the Speed Adjusted Volume press the Off, 1, 2 or 3 soft-key followed by pressing the arrow back soft-key.

- **Surround Sound**

Press the Surround Sound soft-key to change this display. Provides simulated surround sound mode. To make your selection, press the Surround Sound soft-key, select ON or OFF followed by pressing the arrow back soft-key.

### Phone / Bluetooth

- **Paired Devices**

This feature shows which phones are paired to the Phone/Bluetooth system. For

further information, refer to the Uconnect Touch™ Supplement.

### SIRIUS Setup

- **Channel Skip**

SIRIUS can be programmed to designate a group of channels that are the most desirable to listen to or to exclude undesirable channels while scanning. To make your selection, press the Channel Skip Seats soft-key, select the channels you would like to skip followed by pressing the arrow back soft-key.

- **Subscription Info**

New vehicle purchasers or lessees will receive a free limited time subscription to SIRIUS Satellite Radio with your radio. Following expiration of the free services, it

## UNDERSTANDING YOUR INSTRUMENT PANEL

will be necessary to access the information on the Subscription Information screen in order to re-subscribe.

Touch the Subscription Info soft-key to access the Subscription Information screen.

Write down the SIRIUS ID numbers for your receiver. To reactivate your service, either call the number listed on the screen or visit the provider online.

**NOTE:** *SIRIUS Travel Link is a separate subscription.*

### Uconnect Touch™ System 8.4 Settings — Customer Programmable Features

Press the More soft-key, then press the Settings soft-key to display the menu setting screen. In this mode the Uconnect Touch™ system allows you to access pro-

grammable features that may be equipped such as Display, Clock, Safety/ Assistance, Lights, Doors & Locks, Auto-On Comfort & Remote Start, Engine Off Operation, Compass Settings, Audio, Phone/Bluetooth and SIRIUS Setup.

**NOTE:** *Only one touchscreen area may be selected at a time.*

art-044435868.tif NO TRANS



Uconnect Touch™ 8.4 Soft-keys

When making a selection, press the soft-key to enter the desired mode. Once in the desired mode press and release the preferred setting until a check-mark appears next to the setting, showing that setting has been selected.

Once the setting is complete press the Back Arrow soft-key to return to the previous menu or press the X soft-key to close out of the settings screen. Pressing the Up or Down Arrow soft-keys on the right side of the screen will allow you to toggle up or down through the available settings.

### Display

After pressing the Display soft-key the following settings will be available.

- **Display Mode**

When in this display you may select one of the auto display settings. To change Mode

## UNDERSTANDING YOUR INSTRUMENT PANEL

status press and release the Day, Night or Auto soft-key followed by pressing the arrow back soft-key.

- **Display Brightness with Headlights ON**

When in this display you may select display brightness with the headlights on and the headlights off. Adjust the brightness with the + and – setting soft-keys or by selecting any point on the scale in between the + and – soft-keys followed by pressing the arrow back soft-key.

- **Display Brightness with Headlights OFF**

When in this display you may select display brightness with the headlights on and the headlights off. Adjust the brightness with the + and – setting soft-keys or by selecting any point on the scale in be-

tween the + and – soft-keys followed by pressing the arrow back soft-key.

- **Set Language**

When in this display you may select one of three languages for all display nomenclature, including the trip functions and the navigation system (if equipped). Press the Set Language soft-key and then press the desired language soft-key until a check-mark appears next to the language, showing that setting has been selected. Press the back arrow soft-key to return to the previous menu.

- **Units**

When in this display you may select to have the EVIC, odometer, and navigation system (if equipped) changed between US and Metric units of measure. Press US or Metric until a check-mark appears next to the setting, showing that setting has

been selected. Press the back arrow soft-key to return to the previous menu.

- **Voice Response Length**

When in this display you may change the Voice Response Length settings. To change the Voice Response Length press the Brief or Detailed soft-key until a check-mark appears next to the setting, showing that setting has been selected. Press the back arrow soft-key to return to the previous menu.

- **Touchscreen Beep**

When in this display you may turn on or shut off the sound heard when a touchscreen button (soft-key) is pressed. Press the Touchscreen Beep soft-key until a check-mark appears next to the setting, showing that setting has been selected. Press the back arrow soft-key to return to the previous menu.

---

## UNDERSTANDING YOUR INSTRUMENT PANEL

- **Navigation Turn-By-Turn in Cluster**

When this feature is selected, the turn-by-turn directions will appear in the display as the vehicle approaches a designated turn within a programmed route. To make your selection, press the Navigation Turn-By-Turn in Cluster soft-key, until a check-mark appears next to the setting, showing that setting has been selected. Press the back arrow soft-key to return to the previous menu.

- **Fuel Saver Display in Cluster**

The "ECO" message is located in the instrument cluster display, this message can be turned on or off. To make your selection, press the Fuel Saver Display soft-key, until a check-mark appears next to the setting, showing that setting has been selected. Press the back arrow soft-key to return to the previous menu.

### **Clock**

After pressing the Clock soft-key the following settings will be available.

- **Sync Time with GPS**

When in this display you may automatically have the radio set the time. To change the Sync Time setting press the Sync with GPS Time soft-key until a check-mark appears next to the setting, showing that setting has been selected. Press the back arrow soft-key to return to the previous menu.

- **Set Time Hours**

When in this display you may adjust the hours. The Sync with GPS Time soft-key must be unchecked. To make your selection press the + or - soft-keys to adjust the hours up or down. Press the back arrow soft-key to return to the previous menu or

press the X soft-key to close out of the settings screen.

- **Set Time Minutes**

When in this display you may adjust the minutes. The Sync with GPS Time soft-key must be unchecked. To make your selection press the + or - soft-keys to adjust the minutes up or down. Press the back arrow soft-key to return to the previous menu or press the X soft-key to close out of the settings screen.

- **Time Format**

When in this display you may select the time format display setting. Press the Time Format soft-key until a check-mark appears next to the 12hrs or 24hrs setting, showing that setting has been selected. Press the back arrow soft-key to return to the previous menu.

## UNDERSTANDING YOUR INSTRUMENT PANEL

- **Show Time in Status Bar**

When in this display you may turn on or shut off the digital clock in the status bar. To change the Show Time Status setting press the Show Time in Status Bar soft-key until a check-mark appears next to setting, showing that setting has been selected. Press the back arrow soft-key to return to the previous menu.

### **Safety / Assistance**

After pressing the Safety / Assistance soft-key the following settings will be available.

- **Front Collision Sensitivity**

The Front Collision Warning (FCW) feature can be set to Far, set to Near or turned Off. The default status of FCW is the Far setting. This means the system will warn you of a possible collision with the vehicle in front of you when you are farther away. This gives you the most reaction

time. To change the setting for more dynamic driving select the Near setting. This warns you of a possible collision with the vehicle in front of you when you are much closer. This allows for a more dynamic driving experience. To change FCW status press and release the Off, Near or Far button followed by pressing the arrow back soft-key.

For further information, refer to "Adaptive Cruise Control (ACC)" in "Understanding The Features Of Your Vehicle".

- **Park Assist**

The Rear Park Assist system will scan for objects behind the vehicle when the transmission shift lever is in REVERSE and the vehicle speed is less than 11 mph (18 km/h). The system can be enabled with Sound Only, Sound and Display, or turned OFF. To change the Park Assist

status press and release the Off, Sound Only or Sounds and Display button followed by pressing the arrow back soft-key. Refer to "Rear Park Assist System" in "Understanding The Features Of Your Vehicle" for system function and operating information.

- **Tilt Mirrors In Reverse**

When this feature is selected, the outside sideview mirrors will tilt downward when the ignition is in the RUN position and the transmission shift lever is in the REVERSE position. The mirrors will move back to their previous position when the transmission is shifted out of REVERSE. To make your selection, press the Tilt Mirrors in Reverse soft-key, until a check-mark appears next to setting, showing that setting has been selected. Press the back arrow soft-key to return to the previous menu.

---

## UNDERSTANDING YOUR INSTRUMENT PANEL

- **Blind Spot Alert**

When this feature is selected the Blind Spot Alert feature can be set to Off, Lights or Lights and Chime. The Blind Spot Alert feature can be activated in "Lights" mode, when this mode is selected the Blind Spot Monitor (BSM) system is activated and will only show a visual alert in the outside mirrors. When "Lights & Chime" mode is activated the Blind Spot Monitor (BSM) will show a visual alert in the outside mirrors as well as an audible alert when the turn signal is on. When "Off" is selected the Blind Spot Monitor (BSM) system is deactivated. To change the Blind Spot Alert status press the Off, Lights or Lights & Chime soft-key followed by pressing the arrow back soft-key.

**NOTE:** *If your vehicle has experienced any damage in the area where the sensor*

*is located, even if the fascia is not damaged, the sensor may have become misaligned. Take your vehicle to an authorized dealer to verify sensor alignment. Having a sensor that is misaligned will result in the BSM not operating to specification.*

- **Parkview Backup Camera**

Your vehicle may be equipped with the ParkView® Rear Back Up Camera that allows you to see an on-screen image of the rear surroundings of your vehicle whenever the shift lever is put into REVERSE. The image will be displayed on the radio touchscreen display along with a caution note to "check entire surroundings" across the top of the screen. After five seconds this note will disappear. The ParkView® camera is located on the rear of the vehicle above the rear License

plate. To make your selection, press the Parkview Backup Camera soft-key, until a check-mark appears next to setting, showing that setting has been selected. Press the back arrow soft-key to return to the previous menu.

- **Rain Sensing Auto Wipers**

When this feature is selected, the system will automatically activate the windshield wipers if it senses moisture on the windshield. To make your selection, press the Rain Sensing soft-key, until a check-mark appears next to setting, showing that setting has been selected. Press the back arrow soft-key to return to the previous menu.

- **Hill Start Assist**

When this feature is selected, the Hill Start Assist (HSA) system is active. Refer to "Electronic Brake Control System" in

## UNDERSTANDING YOUR INSTRUMENT PANEL

“Starting And Operating” for system function and operating information. To make your selection, press the Hill Start Assist soft-key, until a check-mark appears next to setting, showing that setting has been selected. Press the back arrow soft-key to return to the previous menu.

### Lights

After pressing the Lights soft-key the following settings will be available.

- **Headlight Off Delay**

When this feature is selected, the driver can choose to have the headlights remain on for 0, 30, 60, or 90 seconds when exiting the vehicle. To change the Headlight Off Delay status press the 0, 30, 60 or 90 soft-key followed by pressing the arrow back soft-key.

- **Headlight Illumination on Approach**

When this feature is selected, the headlights will activate and remain on for 0, 30, 60, or 90 seconds when the doors are unlocked with the RKE transmitter. To change the Illuminated Approach status press the + or - soft-key to select your desired time interval. Press the back arrow soft-key to return to the previous menu.

- **Headlights with Wipers**

When this feature is selected, and the headlight switch is in the AUTO position, the headlights will turn on approximately 10 seconds after the wipers are turned on. The headlights will also turn off when the wipers are turned off if they were turned on by this feature. To make your selection, press the Headlights with Wipers soft-key, until a check-mark appears next to setting, showing that setting has been se-

lected. Press the back arrow soft-key to return to the previous menu.

- **Auto Dim High Beams**

When this feature is selected, the high beam headlights will deactivate automatically under certain conditions. To make your selection, press the Auto High Beams soft-key, until a check-mark appears next to setting, showing that setting has been selected. Press the back arrow soft-key to return to the previous menu.. Refer to “Lights/SmartBeam™ — If Equipped” in “Understanding The Features Of Your Vehicle” for further information.

- **Daytime Running Lights**

When this feature is selected, the headlights will turn on whenever the engine is running. To make your selection, press the Daytime Running Lights soft-key, until a check-mark appears next to setting.



---

## UNDERSTANDING YOUR INSTRUMENT PANEL

showing that setting has been selected. Press the back arrow soft-key to return to the previous menu.

- **Steering Directed Lights**

When this feature is selected, the headlights turn relative to a change in direction of the steering wheel. To make your selection, press the Steering Directed Lights soft-key, until a check-mark appears next to setting, showing that setting has been selected. Press the back arrow soft-key to return to the previous menu.

- **Headlight Dip (Traffic Changeover)**

Low beam headlights have more control of upward light and direct most of their light downward and either to the right for right hand drive countries or to the left for left hand drive countries to provide safe forward visibility without excessive glare.

- **Flash Headlights With Lock**

When this feature is selected, the front and rear turn signals will flash when the doors are locked or unlocked with the RKE transmitter. This feature may be selected with or without the sound horn on lock feature selected. To make your selection, press the Flash Headlights with Lock soft-key, until a check-mark appears next to setting, showing that setting has been selected. Press the back arrow soft-key to return to the previous menu.

### Doors & Locks

After pressing the Doors & Locks soft-key the following settings will be available.

- **Auto Unlock on Exit**

When this feature is selected, all doors will unlock when the vehicle is stopped and the transmission is in the PARK or NEUTRAL position and the driver's door is

opened. To make your selection, press the Auto Unlock on Exit soft-key, until a check-mark appears next to setting, showing that setting has been selected. Press the back arrow soft-key to return to the previous menu.

- **Flash Headlight with Lock**

When this feature is selected, the front and rear turn signals will flash when the doors are locked or unlocked with the RKE transmitter. To make your selection, press the Flash Lights with Lock soft-key, until a check-mark appears next to setting, showing that setting has been selected. Press the back arrow soft-key to return to the previous menu.

- **Sound Horn with Lock**

When this feature is selected, the horn will sound when the remote start is activated. To make your selection, press the Sound

## UNDERSTANDING YOUR INSTRUMENT PANEL

Horn with Remote Start soft-key, until a check-mark appears next to setting, showing that setting has been selected. Press the back arrow soft-key to return to the previous menu.

- **Sound Horn with Remote Start**

When this feature is selected, the horn will sound when the remote start is activated. To make your selection, press the Sound Horn with Remote Start soft-key, until a check-mark appears next to setting, showing that setting has been selected. Press the back arrow soft-key to return to the previous menu.

- **1st Press of Key Fob Unlocks**

When **Unlock Driver Door Only On 1st Press** is selected, only the driver's door will unlock on the first press of the RKE transmitter UNLOCK button. When Driver Door 1st Press is selected, you must press

the RKE transmitter UNLOCK button twice to unlock the passenger's doors. When **Unlock All Doors On 1st Press** is selected, all of the doors will unlock on the first press of the RKE transmitter UNLOCK button.

**NOTE:** *If the vehicle is programmed Unlock All Doors 1st Press, all doors will unlock no matter which Passive Entry equipped door handle is grasped. If Driver Door 1st Press is programmed, only the driver's door will unlock when the driver's door is grasped. With Passive Entry, if Driver Door 1st Press is programmed touching the handle more than once will only result in the driver's door opening. If driver door first is selected, once the driver door is opened, the interior door lock/unlock switch can be used to unlock all doors (or use RKE transmitter).*

- **Passive Entry**

This feature allows you to lock and unlock the vehicle's door(s) without having to press the RKE transmitter lock or unlock buttons. To make your selection, press the Passive Entry soft-key, until a check-mark appears next to setting, showing that setting has been selected. Press the back arrow soft-key to return to the previous menu.. Refer to "Keyless Enter-N-Go" in "Things To Know Before Starting Your Vehicle".

- **Personal Settings Linked to FOB**

This feature provides automatic driver seat positioning to enhance driver mobility when entering and exiting the vehicle. To make your selection, press the Memory Linked to FOB soft-key, until a check-mark

## UNDERSTANDING YOUR INSTRUMENT PANEL

appears next to setting, showing that setting has been selected. Press the back arrow soft-key to return to the previous menu.

**NOTE:** *The seat will return to the memorized seat location (if Recall Memory with Remote Key Unlock is set to ON) when the RKE transmitter is used to unlock the door. Refer to "Driver Memory Seat" in "Understanding The Features Of Your Vehicle" for further information.*

### **Auto-On Comfort & Remote Start**

After pressing the Auto-On Comfort & Remote Start soft-key the following settings will be available.

- **Horn with Remote Start**

When this feature is selected, the horn will sound when the remote start is activated. To make your selection, press the Sound

Horn with Remote Start soft-key, until a check-mark appears next to setting, showing that setting has been selected. Press the back arrow soft-key to return to the previous menu.

- **Auto-on Driver Heated/Ventilated Seat & Steering Wheel with Vehicle Start**

When this feature is selected the driver's heated seat and heated steering wheel will automatically turn on when temperatures are below 40° F (4.4° C). When temperatures are above 80° F (26.7° C) the driver vented seat will turn on. To make your selection, press the Auto Heated Seats soft-key, until a check-mark appears next to setting, showing that setting has been selected. Press the back arrow soft-key to return to the previous menu.

### **Engine Off Options**

After pressing the Engine Off Options soft-key the following settings will be available.

- **Easy Exit Seat**

This feature provides automatic driver seat positioning to enhance driver mobility when entering and exiting the vehicle. To make your selection, press the Easy Exit Seats soft-key, until a check-mark appears next to setting, showing that setting has been selected. Press the back arrow soft-key to return to the previous menu.

- **Engine Off Power Delay**

When this feature is selected, the power window switches, radio, Uconnect™ phone system (if equipped), DVD video system (if equipped), power sunroof (if equipped), and power outlets will remain active for up to 10 minutes after the ignition is cycled to OFF. Opening either front

## UNDERSTANDING YOUR INSTRUMENT PANEL

vehicle door will cancel this feature. To change the Engine Off Power Delay status press the 0 seconds, 45 seconds, 5 minutes or 10 minutes soft-key followed by pressing the arrow back soft-key.

### • **Headlight Off Delay**

When this feature is selected, the driver can choose to have the headlights remain on for 0, 30, 60, or 90 seconds when exiting the vehicle. To change the Headlight Off Delay status press the + or - soft-key to select your desired time interval. Press the back arrow soft-key to return to the previous menu.

### Compass Settings

After pressing the Compass Settings soft-key the following settings will be available.

### • **Variance**

Compass Variance is the difference between Magnetic North and Geographic North. To compensate for the differences the variance should be set for the zone where the vehicle is driven, per the zone map. Once properly set, the compass will automatically compensate for the differences, and provide the most accurate compass heading. For the most accurate compass performance, the compass must be set using the following steps.

**NOTE:** *Keep magnetic materials away from the top of the instrument panel, such as iPod's, Mobile Phones, Laptops and Radar Detectors. This is where the compass module is located, and it can cause interference with the compass sensor, and it may give false readings.*

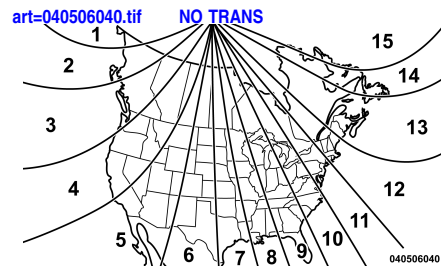

Compass Variance Map

### • **Perform Compass Calibration**

Press the Calibration key to change this setting. This compass is self-calibrating, which eliminates the need to manually reset the compass. When the vehicle is new, the compass may appear erratic and the EVIC will display CAL until the compass is calibrated. You may also calibrate the compass by pressing the ON soft-key and completing one or more 360-degree

---

## UNDERSTANDING YOUR INSTRUMENT PANEL

turns (in an area free from large metal or metallic objects) until the CAL indicator displayed in the EVIC turns off. The compass will now function normally.

### **Audio**

After pressing the Audio soft-key the following settings will be available.

- **Balance/Fade**

When in this display you may adjust the Balance and Fade settings.

- **Equalizer**

When in this display you may adjust the Bass, Mid and Treble settings. Adjust the settings with the + and – setting soft-keys or by selecting any point on the scale in between the + and – soft-keys followed by pressing the arrow back soft-key.

**NOTE:** *Bass/mid/treble allow the you to simply slide your finger up/down to change the setting as well as press directly on the desired setting.*

- **Speed Adjusted Volume**

Decreases volume relative to vehicle speed. To change the Speed Adjusted Volume press the Off, 1, 2 or 3 soft-key followed by pressing the arrow back soft-key.

- **Music Info Cleanup**

This feature helps organize music files for optimized music navigation. To make your selection, press the Music Info Cleanup soft-key, select On or Off followed by pressing the arrow back soft-key.

### **Phone/Bluetooth**

After pressing the Phone/Bluetooth soft-key the following settings will be available.

- **Paired Devices**

This feature shows which phones are paired to the Phone/Bluetooth system. For further information, refer to the Uconnect Touch™ Supplement.

### **SIRIUS Setup**

After pressing the SIRIUS Setup soft-key the following settings will be available.

- **Channel Skip**

SIRIUS can be programmed to designate a group of channels that are the most desirable to listen to or to exclude undesirable channels while scanning. To make your selection, press the Channel Skip Seats soft-key, select the channels you would like to skip followed by pressing the arrow back soft-key.

## UNDERSTANDING YOUR INSTRUMENT PANEL

### • **Subscription Information**

New vehicle purchasers or lessees will receive a free limited time subscription to SIRIUS Satellite Radio with your radio. Following expiration of the free services, it will be necessary to access the information on the Subscription Information screen in order to re-subscribe.

Touch the Subscription Info soft-key to access the Subscription Information screen.

Write down the SIRIUS ID numbers for your receiver. To reactivate your service, either call the number listed on the screen or visit the provider online.

**NOTE:** *SIRIUS Travel Link is a separate subscription.*

### **VIDEO ENTERTAINMENT SYSTEM (VES)™ — IF EQUIPPED**

The optional Video Entertainment System (VES)™ includes the following components for rear seat entertainment:

- A diagonal 9 in (22 cm) Liquid Crystal Display (LCD) screen integrated into the center overhead console. The screen features brightness control for optimum daytime and nighttime viewing.
- The LCD Screen swings down from the console to allow the rear seat passenger(s) to view the display.

art=044906077.tif

NO TRANS



#### **VES™ with Rear HVAC Controls**

- The touch screen radio and DVD player controls allow front seat operation for easy setup in the case of younger rear seat passengers.
- A battery-powered infrared remote control that snaps into a molded compartment in the center console.

**UNDERSTANDING YOUR INSTRUMENT PANEL**

- Two wireless infrared headsets allow rear seat passengers to listen to the same or individual audio sources.

art=044900232.tif NO TRANS

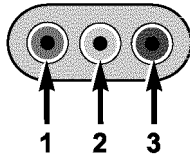

Audio/Video RCA Jacks (AUX Jacks) on the rear of the center console enable the monitor to display video directly from a video camera, connect video

games for display on the screen, or play music directly from an MP3 player.

1. Video in (yellow)
2. Left audio in (white)
3. Right audio in (red)

**NOTE:** Refer to your "Uconnect Touch™ User's Manual" for detailed operating instructions.

**iPod®/USB/MP3 CONTROL— IF EQUIPPED**

This feature allows an iPod® or external USB device to be plugged into the USB port.

iPod® control supports Mini, 4G, Photo, Nano, 5G iPod® and iPhone® devices. Some iPod® software versions may not fully support the iPod® control features. Please visit Apple's website for software updates.

For further information, refer to the Uconnect Touch™ User's Manual.

**STEERING WHEEL AUDIO CONTROLS — IF EQUIPPED**

The remote sound system controls are located on the rear surface of the steering wheel. The left and right-hand controls are rocker-type switches with a pushbutton in the center of each switch. Reach behind the steering wheel to access the switches.

art=045035190.tif NO TRANS

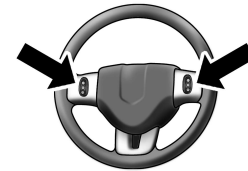

045035190

**Remote Sound Controls (Back View Of Steering Wheel)**

## UNDERSTANDING YOUR INSTRUMENT PANEL

### Right-Hand Switch Functions

- Press the top of the switch to increase the volume.
- Press the bottom of the switch to decrease the volume.
- Press the button in the center of the switch to change modes (i.e., AM, FM, etc.).

### Left-Hand Switch Functions for Radio Operation

- Press the top of the switch to SEEK the next listenable station up from the current setting.
- Press the bottom of the switch to SEEK the next listenable station down from the current setting.

- Press the button in the center of the switch to tune to the next preset that you have programmed.

### Left-Hand Switch Functions for Media (i.e., CD) Operation

- Press the top of the switch once to listen to the next track.
- Press the bottom of the switch once either to listen to the beginning of the current track or to listen to the beginning of the previous track if it is within one second after the current track begins to play.
- Press the switch up or down twice to listen to the second track, three times to listen to the third track, and so forth.

- Press the button located in the center of the switch to change to the next preset that you have programmed.

### CD/DVD DISC MAINTENANCE

To keep a CD/DVD in good condition, take the following precautions:

1. Handle the disc by its edge; avoid touching the surface.
2. If the disc is stained, clean the surface with a soft cloth, wiping from center to edge.
3. Do not apply paper or tape to the disc; avoid scratching the disc.
4. Do not use solvents such as benzene, thinner, cleaners, or anti-static sprays.
5. Store the disc in its case after playing.



## UNDERSTANDING YOUR INSTRUMENT PANEL

6. Do not expose the disc to direct sunlight.
7. Do not store the disc where temperatures may become too high.

**NOTE:** *If you experience difficulty in playing a particular disc, it may be damaged (i.e., scratched, reflective coating removed, a hair, moisture or dew on the disc) oversized, or have protection encoding. Try a known good disc before considering disc player service.*

### RADIO OPERATION AND MOBILE PHONES

Under certain conditions, the mobile phone being on in your vehicle can cause erratic or noisy performance from your radio. This condition may be lessened or eliminated by relocating the mobile phone antenna. This condition is not harmful to

the radio. If your radio performance does not satisfactorily "clear" by the repositioning of the antenna, it is recommended that the radio volume be turned down or off during mobile phone operation when not using Uconnect™ (if equipped).

### CLIMATE CONTROLS

#### General Overview

The air conditioning and heating system is designed to make you comfortable in all types of weather. This system can be operated through either the Automatic Climate Controls on the instrument panel or through the Uconnect Touch™ system display.

When the Uconnect Touch™ system is in different modes (Radio, Player, Settings, More, etc.) the driver and passenger tem-

perature settings will be indicated at the top of the display.

#### Hard-Keys

Hard-keys are located on the left and right side of the Uconnect Touch™ 4.3 screen in the center of the instrument panel. There are also hard-keys located below the Uconnect Touch™ screen.

[art=044336084.tif](#) NO TRANS



044336084

1 — Uconnect Touch™ System 4.3 Climate Hard-key

**UNDERSTANDING YOUR INSTRUMENT PANEL**

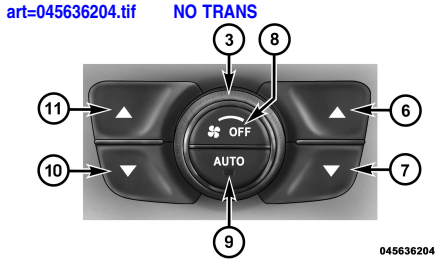

**Automatic Temperature Controls — Hard-keys**

**Soft-Keys**

Soft-keys are accessible on the Uconnect Touch™ system screen.

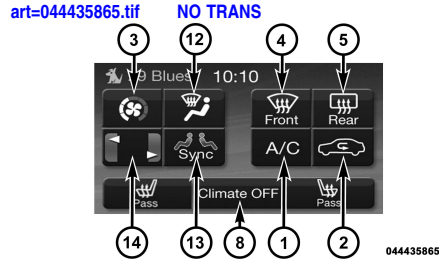

**Uconnect Touch™ System 4.3 Manual Temperature Controls — Soft-keys**

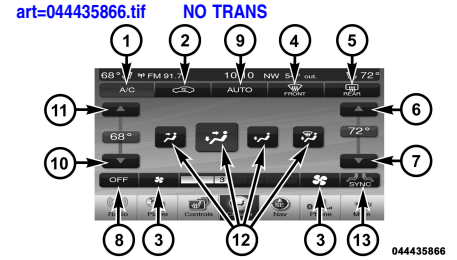

**Uconnect Touch™ System 8.4 Automatic Temperature Controls — Soft-keys**

**Button Descriptions (Applies To Both Hard-keys And Soft-keys)**

**1. A/C Button**

Press and release to change the current Air Conditioning (A/C) setting, the indicator illuminates when A/C is ON. If equipped with ATC, performing this function will cause the automatic operation to

---

## UNDERSTANDING YOUR INSTRUMENT PANEL

switch into manual mode and the AUTO indicator will turn off.

### **2. Recirculation Control Button**

Press and release to change the current setting, the indicator illuminates when ON.

### **3. Blower Control**

Blower control is used to regulate the amount of air forced through the climate system. There are seven blower speeds available. Adjusting the blower will cause automatic mode to switch to manual operation if equipped with ATC. The speeds can be selected using either hard-neys or soft-keys as follows:

#### **Hard-key**

The blower speed increases as you turn the control clockwise from the lowest

blower setting. The blower speed decreases as you turn the knob counter-clockwise.

#### **Soft-key — Uconnect Touch™ System**

##### **4.3**

Press the blower soft-key to enter the blower setting screen. Once in the blower settings screen use the UP and DOWN arrows to adjust the blower speed setting, or directly select the speed setting by pressing the blower bar area around the blower icon. The blower speed increases as you press the UP arrow or move clockwise on the setting scale and decreases when press the DOWN arrow or move counter-clockwise on the setting scale.

#### **Soft-key — Uconnect Touch™ System**

##### **8.4**

Use the small blower icon to reduce the blower setting and the large blower icon to

increase the blower setting. Blower can also be selected by pressing the blower bar area between the icons.

#### **4. Front Defrost Button**

Press and release to change the current airflow setting to Defrost mode. The indicator illuminates when this feature is ON. Performing this function will cause the ATC to switch into manual mode (if equipped). The blower speed may increase when Defrost mode is selected. If the front defrost mode is turned off the climate system will return the previous setting.

#### **5. Rear Defrost Button**

Press and release this button to turn on the rear window defroster and the heated outside mirrors (if equipped). An indicator will illuminate when the rear window defroster is on. The rear window defroster automatically turns off after 10 minutes.

## UNDERSTANDING YOUR INSTRUMENT PANEL

### CAUTION!

Failure to follow these cautions can cause damage to the heating elements:

- Use care when washing the inside of the rear window. Do not use abrasive window cleaners on the interior surface of the window. Use a soft cloth and a mild washing solution, wiping parallel to the heating elements. Labels can be peeled off after soaking with warm water.
- Do not use scrapers, sharp instruments, or abrasive window cleaners on the interior surface of the window.

- Keep all objects a safe distance from the window.

### 6. Passenger Temperature Control Up Button

Provides the passenger with independent temperature control. Push the button for warmer temperature settings.

**NOTE:** Pressing this button while in Sync mode will automatically exit Sync.

### 7. Passenger Temperature Control Down Button

Provides the passenger with independent temperature control. Push the button for cooler temperature settings.

**NOTE:** Pressing this button while in Sync mode will automatically exit Sync.

### 8. Climate Control OFF Button

Press and release this button to turn the Climate Control ON/OFF.

### 9. AUTO Operation Button — If Equipped

Automatically controls the interior cabin temperature by adjusting airflow distribution and amount. Performing this function will cause the ATC to switch between manual mode and automatic modes. Refer to "Automatic Operation" for more information.

### 10. Driver Temperature Control Down Button

Provides the driver with independent temperature control. Push the button for cooler temperature settings.

**UNDERSTANDING YOUR INSTRUMENT PANEL**

**NOTE:** In Sync mode, this button will also automatically adjust the passenger and rear temperature setting at the same time.

**11. Driver Temperature Control Up Button**

Provides the driver with independent temperature control. Push the button for warmer temperature settings.

**NOTE:** In Sync mode, this button will also automatically adjust the passenger and rear temperature setting at the same time.

**12. Modes**

The airflow distribution mode can be adjusted so air comes from the instrument panel outlets, floor outlets, demist outlets and defrost outlets. The Mode settings are as follows:

**Panel Mode**



art=045600401.tif NO TRANS  
Air comes from the outlets in the instrument panel. Each of these outlets can be individually adjusted to direct the flow of air. The air vanes of the center outlets and outboard outlets can be moved up and down or side to side to regulate airflow direction. There is a shut off wheel located below the air vanes to shut off or adjust the amount of airflow from these outlets.

**Bi-Level Mode**



art=045600402.tif NO TRANS  
Air comes from the instrument panel outlets and floor outlets. A slight amount of air is directed through the defrost and side window demister outlets.

**NOTE:** BI-LEVEL mode is designed under comfort conditions to provide cooler air out of the panel outlets and warmer air from the floor outlets.

**Floor Mode**



art=045600403.tif NO TRANS  
Air comes from the floor outlets. A slight amount of air is directed through the defrost and side window demister outlets.

**Mix Mode**



art=045600404.tif NO TRANS  
Air comes from the floor, defrost and side window demist outlets. This mode works best in cold or snowy conditions.

**Defrost Mode**



art=045600405.tif NO TRANS  
Air comes from the windshield and side window demist outlets. Use Defrost mode with maximum temperature settings for best windshield and side window defrosting and defogging. When the defrost mode is selected, the blower level may increase.

## UNDERSTANDING YOUR INSTRUMENT PANEL

### 13. SYNC

Press the Sync soft-key to toggle the Sync feature On/Off. The Sync indicator is illuminated when this feature is enabled. Sync is used to synchronize the passenger and rear temperature setting with the driver temperature setting. Changing the passenger temperature setting while in Sync will automatically exit this feature.

**NOTE:** When SYNC is ON and the driver selects Mix or Defrost Mode, Rear mode will be Floor.

### 14. Temperature Control (Manual Temperature Control Only)

Press the temperature soft-key to regulate the temperature of the air inside the passenger compartment. Moving the temperature bar into the red area, indicates warmer temperatures. Moving the tem-

perature bar into the blue area indicates cooler temperatures.

### Climate Control Functions

#### A/C (Air Conditioning)

The Air Conditioning (A/C) button allows the operator to manually activate or deactivate the air conditioning system. When the air conditioning system is turned on, cool dehumidified air will flow through the outlets into the cabin. For improved fuel economy, press the A/C button to turn off the air conditioning and manually adjust the blower and airflow mode settings.

#### NOTE:

- For Manual Climate Controls, if the system is in Mix or Defrost Mode, the A/C can be turned off.

- If fog or mist appears on the windshield or side glass, select Defrost mode and increase blower speed.
- If your air conditioning performance seems lower than expected, check the front of the A/C condenser (located in front of the radiator), for an accumulation of dirt or insects. Clean with a gentle water spray from behind the radiator and through the condenser. Fabric front fascia protectors may reduce airflow to the condenser, reducing air conditioning performance.

#### Recirculation Control



When outside air contains smoke, odors, or high humidity, or if rapid cooling is desired, you may wish to recirculate interior air by pressing the Recirculation control button. The recirculation

## UNDERSTANDING YOUR INSTRUMENT PANEL

indicator will illuminate when this button is selected. Push the button a second time to turn off the Recirculation mode and allow outside air into the vehicle.

**NOTE:** *In cold weather, use of Recirculation mode may lead to excessive window fogging. The Recirculation mode is not allowed in Mix, Floor and Defrost modes to improve window clearing operation. Recirculation will be disabled automatically if these modes are selected. Attempting to use Recirculation while in these modes will cause the LED in the control button to blink and then turn off.*

### **Automatic Temperature Control (ATC)**

ATC Hard-keys are located in the center of the instrument panel.

Soft-keys are accessible on the Uconnect Touch™ system screen.

### **Automatic Operation**

1. Press the AUTO hard-key or soft-key button (9) on the Automatic Temperature Control (ATC) Panel.
2. Next, adjust the temperature you would like the system to maintain by adjusting the driver and passenger temperature hard or soft control buttons (6, 7, 10, 11). Once the desired temperature is displayed, the system will achieve and automatically maintain that comfort level.
3. When the system is set up for your comfort level, it is not necessary to change the settings. You will experience the greatest efficiency by simply allowing the system to function automatically.

### **NOTE:**

- *It is not necessary to move the tempera-*

*ture settings for cold or hot vehicles. The system automatically adjusts the temperature, mode and blower speed to provide comfort as quickly as possible.*

- *The temperature can be displayed in U.S. or Metric units by selecting the US/M customer-programmable feature. Refer to the “Uconnect Touch™ System Settings” in this section of the manual.*

To provide you with maximum comfort in the Automatic mode, during cold start-ups the blower fan will remain on low until the engine warms up. The blower will increase in speed and transition into Auto mode.

### **Manual Operation**

The system allows for manual selection of blower speed, air distribution mode, A/C status and recirculation control.

## UNDERSTANDING YOUR INSTRUMENT PANEL

The blower fan speed can be set to any fixed speed by adjusting the blower control. The fan will now operate at a fixed speed until additional speeds are selected. This allows the front occupants to control the volume of air circulated in the vehicle and cancel the Auto mode.

The operator can also select the direction of the airflow by selecting one of the available mode settings. A/C operation and Recirculation control can also be manually selected in Manual operation.

### Rear Automatic Temperature Control (ATC) — If Equipped

The rear ATC system has floor air outlets at the rear right side of the 3rd Row seats and overhead outlets at each outboard rear seating position. The system provides

heated air through the floor outlets or cool, dehumidified air through the headliner outlets.

The rear system temperature control is in the Uconnect Touch™ system, located on the instrument panel.

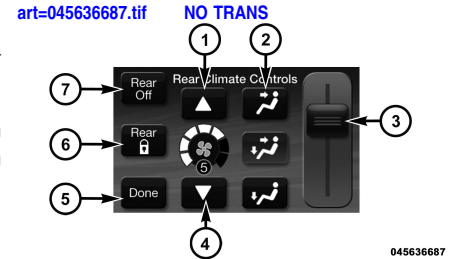

Rear Climate Controls 4.3 Screen

- |                          |                        |
|--------------------------|------------------------|
| 1 — Blower Up Soft-key   | 5 — Done Soft-key      |
| 2 — Mode Soft-key        | 6 — Rear Lock Soft-key |
| 3 — Temperature Soft-key | 7 — Rear Off Soft-key  |
| 4 — Blower Down Soft-key |                        |



**UNDERSTANDING YOUR INSTRUMENT PANEL**

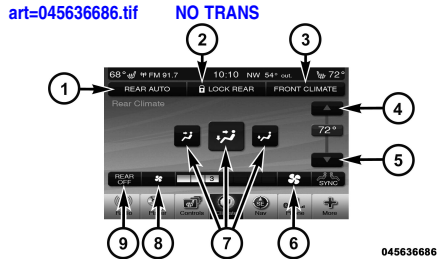

**Rear Climate Controls 8.4 Screen**

- |                               |                          |
|-------------------------------|--------------------------|
| 1 — Rear Auto Soft-key        | 6 — Blower Up Soft-key   |
| 2 — Rear Lock Soft-key        | 7 — Mode Soft-key        |
| 3 — Front Climate Soft-key    | 8 — Blower Down Soft-key |
| 4 — Temperature Up Soft-key   | 9 — Rear Off Soft-key    |
| 5 — Temperature Down Soft-key |                          |

**Rear Lock**

Pressing the Rear Temperature Lock soft-key on the Uconnect Touch™ screen, illuminates a lock symbol in the rear display. The rear temperature and air source are controlled from the front Uconnect Touch™ system.

Rear second row occupants can only adjust the rear ATC control when the Rear Temperature Lock button is turned off.

The rear ATC is located in the headliner, near the center of the vehicle.

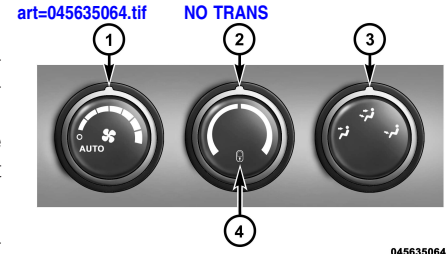

**Rear ATC Control Features**

- |                      |                           |
|----------------------|---------------------------|
| 1 - Blower Speed     | 3 - Rear MODE             |
| 2 - Rear Temperature | 4 - Rear Temperature Lock |

- Press the Rear Temperature Lock button on the Uconnect Touch™ screen. This turns off the Rear Temperature Lock icon in the rear temperature knob.

## UNDERSTANDING YOUR INSTRUMENT PANEL

- Rotate the Rear Blower, Rear Temperature and the Rear Mode Control knobs to suit your comfort needs.
- ATC is selected by adjusting the rear blower knob counterclockwise to AUTO.

Once the desired temperature is displayed, the ATC System will automatically achieve and maintain that comfort level. When the system is set up for your comfort level, it is not necessary to change the settings. You will experience the greatest efficiency by simply allowing the system to function automatically.

**NOTE:** *It is not necessary to move the temperature settings for cold or hot vehicles. The system automatically adjusts the temperature, mode and fan speed to provide comfort as quickly as possible.*

### Rear Blower Control

The rear blower control knob can be manually set to off, or any fixed blower speed, by rotating the knob from low to high. This allows the rear seat occupants to control the volume of air circulated in the rear of the vehicle.

### CAUTION!

**Interior air enters the Rear Automatic Temperature Control System through an intake grille, located in the right side trim panel behind the third row seats. The rear outlets are located in the right side trim panel of the 3rd Row seat. Do not block or place objects directly in front of the inlet grille or heater outlets. The electrical system could overload causing damage to the blower motor.**

### Rear Temperature Control

To change the temperature in the rear of the vehicle, rotate the temperature knob

## UNDERSTANDING YOUR INSTRUMENT PANEL

counterclockwise to lower the temperature, and clockwise to increase the temperature. The rear temperature settings are displayed in the Uconnect Touch™ system.

When rear controls are locked by the Uconnect Touch™ system, the Rear Temperature Lock symbol on the temperature knob is illuminated and any rear overhead adjustments are ignored.

### Rear Mode Control

#### Auto Mode

The rear system automatically maintains the correct mode and comfort level desired by the rear seat occupants.

#### Headliner Mode

[art=045600401.tif](#) NO TRANS



Air comes from the outlets in the headliner. Each of these outlets can

be individually adjusted to direct the flow of air. Moving the air vanes of the outlets to one side will shut off the airflow.

#### Bi-Level Mode

[art=045600402.tif](#) NO TRANS



Air comes from both the headliner outlets and the floor outlets.

**NOTE:** *In many temperature positions, the BI-LEVEL mode is designed to provide cooler air out of the headliner outlets and warmer air from the floor outlets.*

#### Floor Mode

[art=045600403.tif](#) NO TRANS



Air comes from the floor outlets.

### Operating Tips

**NOTE:** *Refer to the chart at the end of this section for suggested control settings for various weather conditions.*

### Summer Operation

The engine cooling system in air-conditioned vehicles must be protected with a high-quality antifreeze coolant to provide proper corrosion protection and to protect against engine overheating. A solution of 50% ethylene glycol antifreeze coolant and 50% water is recommended. Refer to "Maintenance Procedures" in "Maintaining Your Vehicle" for proper coolant selection.

### Winter Operation

Use of the air Recirculation mode during Winter months is not recommended because it may cause window fogging.

### Vacation Storage

Any time you store your vehicle or keep it out of service (i.e., vacation) for two weeks or more, run the air conditioning system at idle for about five minutes in the fresh air

## UNDERSTANDING YOUR INSTRUMENT PANEL

and high blower setting. This will ensure adequate system lubrication to minimize the possibility of compressor damage when the system is started again.

### Window Fogging

Interior fogging on the windshield can be quickly removed by turning the mode selector to Defrost. The Defrost/Floor mode can be used to maintain a clear windshield and provide sufficient heating. If side window fogging becomes a problem

increase blower speed. Vehicle windows tend to fog on the inside in mild but rainy or humid weather.

**NOTE:** *Recirculate without A/C should not be used for long periods, as fogging may occur.*

### Outside Air Intake

Make sure the air intake, located directly in front of the windshield, is free of obstructions such as leaves. Leaves collected in the air intake may reduce airflow,

and if they enter the plenum, they could plug the water drains. In Winter months, make sure the air intake is clear of ice, slush, and snow.





















### A/C Air Filter

The climate control system filters outside air containing dust, pollen and some odors. Strong odors cannot be totally filtered out. Refer to "Maintenance Procedures" in "Maintaining Your Vehicle" for filter replacement instructions.

**UNDERSTANDING YOUR INSTRUMENT PANEL**

**Manual Control Setting Suggestions For Various Weather Conditions**

art=045636890.tif TRANSLATE

WEATHER	CONTROL SETTINGS
<p>HOT WEATHER AND VEHICLE INTERIOR IS VERY HOT</p>  	<p>Open the windows, start the vehicle, set the Mode control to Panel  or Bi-Level , and turn on A/C. Set the Fan control to the High position (full clockwise). Set the temperature control to full cool. After the hot air is flushed from the vehicle, set the Mode control to Recirculate  with A/C on and roll up the windows. Once you are comfortable, set the Mode control to Panel  or Bi-Level  with A/C on.</p>
<p>WARM WEATHER</p>  	<p>If it's sunny, set the Mode control to Panel  and turn on A/C. If it's cloudy or dark, set the Mode control to Bi-Level  with A/C on. Adjust Temperature control for comfort.</p>
<p>COOL OR COLD HUMID CONDITIONS</p>  	<p>Set the Mode control to Mix  or Defrost . Set the Fan Control to the High position (full clockwise). Adjust Fan and Temperature control for comfort if windows are clear.</p>
<p>COLD DRY CONDITIONS</p>  	<p>Set the Mode control to Floor . If it's sunny, you may want more upper air. In this case, set the Mode control to Bi-Level . In very cold weather, if you need extra heat at the windshield, set the Mode control to Mix  or Defrost  as needed. Adjust Fan and Temperature control for comfort.</p>

**045636890**



# SECTION 5

## STARTING AND OPERATING

• STARTING PROCEDURES . . . . .	254	• DRIVING ON SLIPPERY SURFACES . . . . .	263
• Automatic Transmission . . . . .	254	• Acceleration . . . . .	263
• Keyless Enter-N-Go . . . . .	254	• Traction . . . . .	264
• Normal Starting . . . . .	255	• DRIVING THROUGH WATER . . . . .	264
• Extreme Cold Weather (Below -20°F or -29°C) . . . . .	256	• Flowing/Rising Water . . . . .	264
• If Engine Fails To Start . . . . .	256	• Shallow Standing Water . . . . .	265
• After Starting . . . . .	257	• POWER STEERING . . . . .	266
• ENGINE BLOCK HEATER — IF EQUIPPED . . . . .	257	• Power Steering Fluid Check . . . . .	267
• AUTOMATIC TRANSMISSION . . . . .	257	• PARKING BRAKE . . . . .	267
• Brake/Transmission Shift Interlock System . . . . .	258	• BRAKE SYSTEM . . . . .	269
• Four-Speed or Six-Speed Automatic Transmission . . . . .	259	• Anti-Lock Brake System (ABS) . . . . .	270
• Gear Ranges . . . . .	259	• ELECTRONIC BRAKE CONTROL SYSTEM . . . . .	270
• AUTOSTICK® — IF EQUIPPED . . . . .	262	• Anti-Lock Brake System (ABS) . . . . .	270
• Operation . . . . .	262	• Brake Assist System (BAS) . . . . .	272
• General Information . . . . .	262	• Traction Control System (TCS) . . . . .	273
• ALL WHEEL DRIVE (AWD) — IF EQUIPPED . . . . .	263	• Electronic Roll Mitigation (ERM) . . . . .	273
		• Electronic Stability Control (ESC) . . . . .	274

**STARTING AND OPERATING**

• ESC Activation/Malfunction Indicator Light and ESC OFF Indicator Light . . . . .	275	• TIRE PRESSURE MONITOR SYSTEM (TPMS) . . .	294
• Trailer Sway Control (TSC) . . . . .	276	• Base System . . . . .	296
• TIRE SAFETY INFORMATION . . . . .	277	• Premium System – If Equipped . . . . .	298
• Tire Markings . . . . .	277	• General Information . . . . .	301
• Tire Terminology and Definitions . . . . .	280	• FUEL REQUIREMENTS . . . . .	301
• Tire Loading And Tire Pressure . . . . .	282	• Reformulated Gasoline . . . . .	302
• TIRES — GENERAL INFORMATION . . . . .	285	• Gasoline/Oxygenate Blends . . . . .	302
• Tire Pressure . . . . .	285	• E-85 Usage In Non-Flex Fuel Vehicles . . . . .	303
• Tire Inflation Pressures . . . . .	286	• MMT In Gasoline . . . . .	303
• Radial-Ply Tires . . . . .	287	• Materials Added to Fuel . . . . .	303
• Spare Tire Matching Original Equipped Tire and Wheel – If Equipped . . . . .	288	• Fuel System Cautions . . . . .	304
• Compact Spare Tire – If Equipped . . . . .	288	• Carbon Monoxide Warnings . . . . .	304
• Full Size Spare – If Equipped . . . . .	289	• FLEXIBLE FUEL (3.6L ENGINE ONLY) — IF EQUIPPED . . . . .	305
• Limited-Use Spare – If Equipped . . . . .	289	• E-85 General Information . . . . .	305
• Tire Spinning . . . . .	290	• Ethanol Fuel (E-85) . . . . .	306
• Tread Wear Indicators . . . . .	290	• Fuel Requirements . . . . .	306
• Life Of Tire . . . . .	291	• Selection Of Engine Oil For Flexible Fuel Vehicles (E-85) and Gasoline Vehicles . . . . .	307
• Replacement Tires . . . . .	291	• Starting . . . . .	307
• TIRE CHAINS . . . . .	292	• Cruising Range . . . . .	307
• SNOW TIRES . . . . .	293	• Replacement Parts . . . . .	307
• TIRE ROTATION RECOMMENDATIONS . . . . .	294	• Maintenance . . . . .	308



---

**STARTING AND OPERATING**

• ADDING FUEL . . . . .	308	• Common Towing Definitions . . . . .	311
• Fuel Filler Cap (Gas Cap) . . . . .	308	• Trailer Hitch Classification . . . . .	314
• Loose Fuel Filler Cap Message . . . . .	309	• Trailer Towing Weights (Maximum Trailer Weight Ratings) . . . . .	315
• VEHICLE LOADING . . . . .	309	• Trailer And Tongue Weight . . . . .	317
• Vehicle Certification Label . . . . .	309	• Towing Requirements . . . . .	318
• Gross Vehicle Weight Rating (GVWR) . . . . .	310	• Towing Tips . . . . .	322
• Gross Axle Weight Rating (GAWR) . . . . .	310	• RECREATIONAL TOWING (BEHIND MOTORHOME, ETC) . . . . .	323
• Overloading . . . . .	310		
• Loading . . . . .	311		
• TRAILER TOWING . . . . .	311		

## STARTING AND OPERATING

### STARTING PROCEDURES

Before starting your vehicle, adjust your seat, adjust the inside and outside mirrors, fasten your seat belt, and if present, instruct all other occupants to buckle their seat belts.

#### WARNING!

**Never leave children alone in a vehicle. Leaving unattended children in a vehicle is dangerous for a number of reasons. A child or others could be seriously or fatally injured. Do not leave the ignition in the ACC or RUN position. A child could operate power windows, other controls, or move the vehicle.**

### Automatic Transmission

The shift lever must be in the NEUTRAL or PARK position before you can start the engine. Apply the brakes before shifting into any driving gear.

#### CAUTION!

**Damage to the transmission may occur if the following precautions are not observed:**

- Shift into **PARK** only after the vehicle has come to a complete stop.
- Shift into or out of **REVERSE** only after the vehicle has come to a complete stop and the engine is at idle speed.

- **Do not shift from REVERSE, PARK, or NEUTRAL into any forward gear when the engine is above idle speed.**
- **Before shifting into any gear, make sure your foot is firmly on the brake pedal.**

### Keyless Enter-N-Go



This feature allows the driver to operate the ignition switch with the push of a button, as long as the Remote Keyless Entry (RKE) transmitter is in the passenger

compartment.

---

## STARTING AND OPERATING

### Normal Starting

#### Using the ENGINE START/STOP Button

**NOTE:** Normal starting of either a cold or a warm engine is obtained without pumping or pressing the accelerator pedal.

To start the engine, the transmission must be in PARK or NEUTRAL. Press and hold the brake pedal while pressing the ENGINE START/STOP button once. The system takes over and attempts to start the vehicle. If the vehicle fails to start, the starter will disengage automatically after 10 seconds. If you wish to stop the cranking of the engine prior to the engine starting, press the button again.

#### To Turn Off the Engine Using ENGINE START/STOP Button

1. Place the shift lever in PARK, then press and release the ENGINE START/STOP button.
2. The ignition switch will return to the OFF position.
3. If the shift lever is not in PARK, the ENGINE START/STOP button must be held for two seconds and vehicle speed must be above 5 mph (8 km/h) before the engine will shut off. The ignition switch position will remain in the ACC position until the shift lever is in PARK and the button is pressed twice to the OFF position. If the shift lever is not in PARK and the ENGINE START/STOP button is pressed once, the EVIC (if equipped) will display a "Vehicle Not In Park" message and the

engine will remain running. Never leave a vehicle out of the PARK position, or it could roll.

**NOTE:** If the ignition switch is left in the ACC or RUN (engine not running) position and the transmission is in PARK, the system will automatically time out after 30 minutes of inactivity and the ignition will switch to the OFF position.

#### ENGINE START/STOP Button Functions – With Driver's Foot OFF the Brake Pedal (In PARK or NEUTRAL Position)

The ENGINE START/STOP button operates similar to an ignition switch. It has four positions, OFF, ACC, RUN and START. To change the ignition switch positions without starting the vehicle and use the accessories follow these steps.

## STARTING AND OPERATING

- Starting with the ignition switch in the OFF position:
- Press the ENGINE START/STOP button once to change the ignition switch to the ACC position (EVIC will display "ACC"),
- Press the ENGINE START/STOP button a second time to change the ignition switch to the RUN position (EVIC will display "ON/RUN"),
- Press the ENGINE START/STOP button a third time to return the ignition switch to the OFF position (EVIC will display "OFF").

### Extreme Cold Weather (Below $-20^{\circ}\text{F}$ or $-29^{\circ}\text{C}$ )

To ensure reliable starting at these temperatures, use of an externally powered

electric engine block heater (available from your authorized dealer) is recommended.

### If Engine Fails To Start

#### WARNING!

- **Never pour fuel or other flammable liquids into the throttle body air inlet opening in an attempt to start the vehicle. This could result in a flash fire causing serious personal injury.**

- **Do not attempt to push or tow your vehicle to get it started. Vehicles equipped with an automatic transmission cannot be started this way. Unburned fuel could enter the catalytic converter and once the engine has started, ignite and damage the converter and vehicle. If the vehicle has a discharged battery, booster cables may be used to obtain a start from a booster battery or the battery in another vehicle. This type of start can be dangerous if done improperly. Refer to "Jump Starting" in "What To Do In Emergencies" for further information.**

**Clearing a Flooded Engine (Using ENGINE START/STOP Button)**

If the engine fails to start after you have followed the “Normal Starting” or “Extreme Cold Weather” procedures, it may be flooded. To clear any excess fuel, press and hold the brake pedal, push the accelerator pedal all the way to the floor and hold it, then press and release the ENGINE START/STOP button once. The starter motor will engage automatically, run for 10 seconds, and then disengage. Once this occurs, release the accelerator pedal and the brake pedal, wait 10 to 15 seconds, then repeat the “Normal Starting” procedure.

**After Starting**

The idle speed is controlled automatically and it will decrease as the engine warms up.

**ENGINE BLOCK HEATER — IF EQUIPPED**

The engine block heater warms the engine, and permits quicker starts in cold weather. Connect the cord to a standard 110-115 Volt AC electrical outlet with a grounded, three-wire extension cord.

The engine block heater cord is bundled under the hood between the headlight assembly and the Totally Integrated Power Module (Fuse Box) on the driver’s side of the vehicle.

The engine block heater must be plugged in at least one hour to have an adequate effect on the engine.

**WARNING!**

**Remember to disconnect the engine block heater cord before driving. Damage to the 110-115 Volt electrical cord could cause electrocution.**

**AUTOMATIC TRANSMISSION**

**CAUTION!**

**Damage to the transmission may occur if the following precautions are not observed:**

- **Shift into PARK only after the vehicle has come to a complete stop.**

## STARTING AND OPERATING

- Shift into or out of REVERSE only after the vehicle has come to a complete stop and the engine is at idle speed.
- Do not shift from REVERSE, PARK, or NEUTRAL into any forward gear when the engine is above idle speed.
- Before shifting into any gear, make sure your foot is firmly on the brake pedal.

**NOTE:** *You must press and hold the brake pedal down while shifting out of PARK.*

### WARNING!

- It is dangerous to move the shift lever out of PARK or NEUTRAL if the engine speed is higher than idle speed. If your foot is not firmly on the brake pedal, the vehicle could accelerate quickly forward or in reverse. You could lose control of the vehicle and hit someone or something. Only shift into gear when the engine is idling normally and when your right foot is firmly on the brake pedal.

- Unintended movement of a vehicle could injure those in and near the vehicle. As with all vehicles, you should never exit a vehicle while the engine is running. Before exiting a vehicle, you should always shift the vehicle into PARK, and apply the parking brake. Furthermore, you should never leave unattended children inside a vehicle.

### Brake/Transmission Shift Interlock System

This vehicle is equipped with a Brake Transmission Shift Interlock System (BTSI) that holds the shift lever in the PARK position when the ignition switch is in the LOCK position (OFF position with Keyless Enter-N-Go). To move the shift lever out of the PARK position, the ignition switch must be turned to the ON or START position

## STARTING AND OPERATING

(engine running or not) and the brake pedal must be pressed.

### Four-Speed or Six-Speed Automatic Transmission

The electronically controlled transmission provides a precise shift schedule. The transmission electronics are self-calibrating; therefore, the first few shifts on a new vehicle may be somewhat abrupt. This is a normal condition, and precision shifts will develop within a few hundred miles (kilometers).

art=051010805.tif NO TRANS



Shift Lever

### Gear Ranges

#### PARK

This range supplements the parking brake by locking the transmission. The engine can be started in this range. Never attempt to use PARK while vehicle is in motion. Apply parking brake when leaving vehicle in this range.

When parking on a flat surface, place the shift lever in the PARK position first, and then apply the parking brake.

When parking on a hill, it is important to set the parking brake before placing the shift lever in PARK, otherwise the load on the transmission locking mechanism may make it difficult to move the shift lever out of PARK. As an added precaution, turn the front wheels toward the curb on a downhill grade and away from the curb on an uphill grade.

**STARTING AND OPERATING**

**WARNING!**

- Never use the PARK position as a substitute for the parking brake. Always apply the parking brake fully when parked to guard against vehicle movement and possible injury or damage.
- Never leave children in the vehicle alone. Leaving unattended children in a vehicle is dangerous for a number of reasons. The child or others could be seriously or fatally injured. They could operate the windows, other vehicle controls or move the vehicle.

**CAUTION!**

**DO NOT** race the engine when shifting from PARK or NEUTRAL positions into another gear range as this can damage the drivetrain.

**REVERSE**

This range is for moving the vehicle backward. Shift into REVERSE only after the vehicle has come to a complete stop.

**NEUTRAL**

This range is used when vehicle is standing for prolonged periods with engine running. Engine may be started in this range. Set the parking brake and shift the transmission into PARK if you must leave the vehicle.

**WARNING!**

**Do not coast in NEUTRAL and never turn off the ignition to coast down a hill. These are unsafe practices that limit your response to changing traffic or road conditions. You might lose control of the vehicle and have a collision.**

**DRIVE — Six-Speed Transmission**

This range should be used for most city and highway driving. It provides the smoothest upshifts, downshifts, and best fuel economy. However, use the AutoStick® mode and select the appropriate gear when frequent transmission shifting occurs in the DRIVE range, such as when operating the vehicle under heavy loading conditions, (i.e., in hilly terrain, traveling into strong head winds or while



---

## STARTING AND OPERATING

towing heavy trailers). Under these conditions, reducing shifting by selecting the appropriate gear in AutoStick® will improve performance and extend transmission life by reducing excessive shifting and heat build-up.

### “D” (Overdrive) — Four-Speed Transmission

This range should be used for most city and highway driving. It provides the smoothest upshifts, downshifts, and best fuel economy. However, select the “3” range when frequent transmission shifting occurs while using the “D” (Overdrive) range, such as when operating the vehicle under heavy loading conditions, (i.e., in hilly terrain, traveling into strong head winds or while towing heavy trailers). Under these conditions, using the “3” range will improve performance and extend

transmission life by reducing excessive shifting and heat build-up.

### Reset Mode - Electronic Transmission

The transmission is monitored electronically for abnormal conditions. If a condition is detected that could cause damage, the transmission automatically shifts into second gear (third gear for six-speed automatic). The transmission remains in second gear (third gear for six-speed automatic) despite the forward gear selected. PARK, REVERSE, and NEUTRAL will continue to operate. This Reset feature allows the vehicle to be driven to an authorized dealer for service without damaging the transmission.

In the event of a momentary problem, the transmission can be reset to regain all forward gears by performing the following steps:

1. Stop the vehicle.
2. Shift into PARK.
3. Turn the ignition switch to the LOCK position (OFF position with Keyless Enter-Go).
4. Restart the engine.
5. Shift into the desired gear range and resume driving.

**NOTE:** *Even if the transmission can be reset, it is recommended that you visit an authorized dealer at your earliest possible convenience. Your authorized dealer has diagnostic equipment to determine if the problem could recur.*

If the transmission cannot be reset, authorized dealer service is required.

## STARTING AND OPERATING

### AUTOSTICK® — IF EQUIPPED

AutoStick® is a driver-interactive feature providing manual shift control, giving you more control of the vehicle. AutoStick® allows you to maximize engine braking, eliminate undesirable upshifts and downshifts, and improve overall vehicle performance. This system can also provide you with more control during passing, city driving, cold slippery conditions, mountain driving, trailer towing, and many other situations.

#### Operation

When the shift lever is in the AutoStick® position (below the DRIVE position), it can be moved from side to side. This allows the driver to manually select the transmission gear being used. Moving the shift lever to the left (-) triggers a downshift and to the right (+) an upshift. The gear posi-

tion will display in the instrument cluster on the transmission range indicator.

**NOTE:** *In AutoStick® mode, the transmission will only shift up or down when the driver moves the shift lever to the right (+) or left (-). AutoStick® is deactivated when the shift lever is moved out of the AutoStick® (+/-) position.*

#### General Information

- You can launch the vehicle from a stop in any gear except top gear. The system will ignore attempts to upshift into top gear at too low of a vehicle speed.
- If a ratio other than first is selected, and the vehicle is brought to a stop, the transmission control logic will automatically select the first gear ratio.

- Starting out in second gear is helpful in snow or icy conditions. To select second gear after the vehicle is brought to a stop, tap the shift lever to the right (+) once.
- Avoid using speed control when AutoStick® is engaged.
- Transmission shifting will be more noticeable when AutoStick® is engaged.
- If a downshift would cause the engine to over-speed, that shift will not occur until it is safe for the engine.
- Mostly the transmission will stay in the manually selected ratio, however:
  - If the system detects powertrain overheating, the transmission will revert to the automatic shift mode and

---

**STARTING AND OPERATING**

remain in that mode until the powertrain cools off.

- If the system detects a problem, it will disable the AutoStick® mode and the transmission will return to the automatic mode until the problem is corrected.

**ALL WHEEL DRIVE (AWD) — IF EQUIPPED**

This feature provides on-demand All-Wheel Drive (AWD). The system is automatic with no driver inputs or additional driving skills required. Under normal driving conditions, the front wheels provide most of the traction. If the front wheels begin to lose traction, power is shifted automatically to the rear wheels. The

greater the front wheel traction loss, the greater the power transfer to the rear wheels.

Additionally, on dry pavement under heavy throttle input (where one may have no wheel spin), torque will be sent to the rear in a pre-emptive effort to improve vehicle launch and performance characteristics.

<p><b>CAUTION!</b></p> <p><b>All wheels must have the same size and type tires. Unequal tire sizes must not be used. Unequal tire size may cause failure of the power transfer unit.</b></p>
--

**DRIVING ON SLIPPERY SURFACES**

**Acceleration**

Rapid acceleration on snow covered, wet, or other slippery surfaces may cause the front wheels to pull erratically to the right or left. This phenomenon occurs when there is a difference in the surface traction under the front (driving) wheels.

## STARTING AND OPERATING

### WARNING!

**Rapid acceleration on slippery surfaces is dangerous. Unequal traction can cause sudden pulling of the front wheels. You could lose control of the vehicle and possibly have a collision. Accelerate slowly and carefully whenever there is likely to be poor traction (ice, snow, wet, mud, loose sand, etc.).**

### Traction

When driving on wet or slushy roads, it is possible for a wedge of water to build up between the tire and road surface. This is hydroplaning and may cause partial or complete loss of vehicle control and stopping ability. To reduce this possibility, the following precautions should be observed:

1. Slow down during rainstorms or when the roads are slushy.
2. Slow down if the road has standing water or puddles.
3. Replace the tires when tread wear indicators first become visible.
4. Keep tires properly inflated.
5. Maintain sufficient distance between your vehicle and the vehicle in front of you to avoid a collision in a sudden stop.

### DRIVING THROUGH WATER

Driving through water more than a few inches/centimeters deep will require extra caution to ensure safety and prevent damage to your vehicle.

### Flowing/Rising Water

### WARNING!

**Do not drive on or across a road or path where water is flowing and/or rising (as in storm run-off). Flowing water can wear away the road or path's surface and cause your vehicle to sink into deeper water. Furthermore, flowing and/or rising water can carry your vehicle away swiftly. Failure to follow this warning may result in injuries that are serious or fatal to you, your passengers, and others around you.**

**STARTING AND OPERATING**

**Shallow Standing Water**

Although your vehicle is capable of driving through shallow standing water, consider the following Caution and Warning before doing so.

**CAUTION!**

- Always check the depth of the standing water before driving through it. Never drive through standing water that is deeper than the bottom of the tire rims mounted on the vehicle.
- Determine the condition of the road or the path that is under water and if there are any obstacles in the way before driving through the standing water.

- Do not exceed 5 mph (8 km/h) when driving through standing water. This will minimize wave effects.
- Driving through standing water may cause damage to your vehicle's drivetrain components. Always inspect your vehicle's fluids (i.e., engine oil, transmission, axle, etc.) for signs of contamination (i.e., fluid that is milky or foamy in appearance) after driving through standing water. Do not continue to operate the vehicle if any fluid appears contaminated, as this may result in further damage. Such damage is not covered by the New Vehicle Limited Warranty.

- Getting water inside your vehicle's engine can cause it to lock up and stall out, and cause serious internal damage to the engine. Such damage is not covered by the New Vehicle Limited Warranty.

**WARNING!**

- Driving through standing water limits your vehicle's traction capabilities. Do not exceed 5 mph (8 km/h) when driving through standing water.

## STARTING AND OPERATING

- **Driving through standing water limits your vehicle's braking capabilities, which increases stopping distances. Therefore, after driving through standing water, drive slowly and lightly press on the brake pedal several times to dry the brakes.**
- **Getting water inside your vehicle's engine can cause it to lock up and stall out, and leave you stranded.**
- **Failure to follow these warnings may result in injuries that are serious or fatal to you, your passengers, and others around you.**

### POWER STEERING

The standard power steering system will give you good vehicle response and increased ease of maneuverability in tight

spaces. The system will provide mechanical steering capability if power assist is lost.

If for some reason the power assist is interrupted, it will still be possible to steer your vehicle. Under these conditions, you will observe a substantial increase in steering effort, especially at very low vehicle speeds and during parking maneuvers.

#### NOTE:

- *Increased noise levels at the end of the steering wheel travel are considered normal and do not indicate that there is a problem with the power steering system.*
- *Upon initial start-up in cold weather, the power steering pump may make noise for a short amount of time. This is due to*

*the cold, thick fluid in the steering system. This noise should be considered normal, and it does not in any way damage the steering system.*

#### WARNING!

**Continued operation with reduced power steering assist could pose a safety risk to yourself and others. Service should be obtained as soon as possible.**

## STARTING AND OPERATING

### CAUTION!

**Prolonged operation of the steering system at the end of the steering wheel travel will increase the steering fluid temperature and it should be avoided when possible. Damage to the power steering pump may occur.**

#### Power Steering Fluid Check

Checking the power steering fluid level at a defined service interval is not required. The fluid should only be checked if a leak is suspected, abnormal noises are apparent, and/or the system is not functioning as anticipated. Coordinate inspection efforts through an authorized dealer.

### CAUTION!

**Do not use chemical flushes in your power steering system as the chemicals can damage your power steering components. Such damage is not covered by the New Vehicle Limited Warranty.**

### WARNING!

**Fluid level should be checked on a level surface and with the engine off to prevent injury from moving parts and to ensure accurate fluid level reading. Do not overfill. Use only manufacturer's recommended power steering fluid.**

If necessary, add fluid to restore to the proper indicated level. With a clean cloth,

wipe any spilled fluid from all surfaces. Refer to "Fluids, Lubricants, and Genuine Parts" in "Maintaining Your Vehicle" for the correct fluid type.

### PARKING BRAKE

Before leaving the vehicle, make sure that the parking brake is fully applied. Also, be certain to leave the transmission in PARK.

The foot operated parking brake is located below the lower left corner of the instrument panel. To apply the park brake, firmly push the park brake pedal fully. To release the parking brake, press the park brake pedal a second time and let your foot up as you feel the brake disengage.

## STARTING AND OPERATING

art=054102586.tif NO TRANS

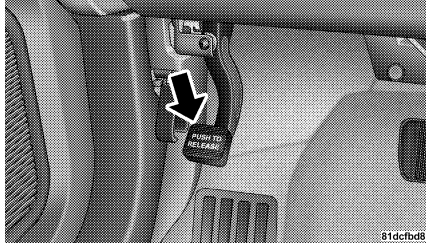

**Parking Brake**

When the parking brake is applied with the ignition switch ON, the “Brake Warning Light” in the instrument cluster will illuminate.

### NOTE:

- When the parking brake is applied and the transmission is placed in gear, the “Brake Warning Light” will flash. If vehicle speed is detected, a chime will sound to alert the driver. Fully release

the parking brake before attempting to move the vehicle.

- This light only shows that the parking brake is applied. It does not show the degree of brake application.

When parking on a hill, it is important to turn the front wheels toward the curb on a downhill grade and away from the curb on an uphill grade. For vehicles equipped with an automatic transmission, apply the parking brake before placing the shift lever in PARK, otherwise the load on the transmission locking mechanism may make it difficult to move the shift lever out of PARK. The parking brake should always be applied whenever the driver is not in the vehicle.

## WARNING!

- Never use the PARK position as a substitute for the parking brake. Always apply the parking brake fully when parked to guard against vehicle movement and possible injury or damage.
- Never leave children alone in a vehicle. Leaving unattended children in a vehicle is dangerous for a number of reasons. A child or others could be seriously or fatally injured.
- Be sure the parking brake is fully disengaged before driving; failure to do so can lead to brake failure and a collision.



**STARTING AND OPERATING**

- **Always fully apply the parking brake when leaving your vehicle or it may roll and cause damage or injury. Also, be certain to leave the transmission in PARK. Failure to do so may cause the vehicle to roll and cause damage or injury.**

**CAUTION!**

**If the “Brake Warning Light” remains on with the parking brake released, a brake system malfunction is indicated. Have the brake system serviced by an authorized dealer immediately.**

**art=054100609.tif** **NO TRANS**  
**BRAKE SYSTEM**

**BRAKE**

Your vehicle is equipped with dual hydraulic brake systems. If either of the two hydraulic systems loses normal capability, the remaining system will still function. However, there will be some loss of overall braking effectiveness. This will be evident by increased pedal travel during application and greater pedal force required to slow or stop the vehicle. In addition, if the malfunction is caused by a leak in the hydraulic system, the “Brake Warning Light” will turn on as the brake fluid level drops in the master cylinder.

In the event power assist is lost for any reason (i.e., repeated brake applications with the engine OFF) the brakes will still function. However, the effort required to

brake the vehicle will be much greater than that required with the power system operating.

**WARNING!**

- **Riding the brakes can lead to brake failure and possibly a collision. Driving with your foot resting or riding on the brake pedal can result in abnormally high brake temperatures, excessive lining wear, and possible brake damage. You would not have your full braking capacity in an emergency.**

## STARTING AND OPERATING

- **Driving a vehicle with the “Brake Warning Light” on is dangerous. A significant decrease in braking performance or vehicle stability during braking may occur. It will take you longer to stop the vehicle or will make your vehicle harder to control. You could have a collision. Have the vehicle checked immediately.**

### Anti-Lock Brake System (ABS)

This system aids the driver in maintaining vehicle control under adverse braking conditions. The system controls hydraulic brake pressure to prevent wheel lock-up to help avoid skidding on slippery surfaces during braking. Refer to “Anti-Lock Brake System (ABS)” under “Electronic

Brake Control System” in this section for more information.

### WARNING!

**The ABS cannot prevent the natural laws of physics from acting on the vehicle, nor can it increase the traction afforded by prevailing road conditions. ABS cannot prevent collisions, including those resulting from excessive speed in turns, driving on very slippery surfaces, or hydroplaning. The capabilities of an ABS-equipped vehicle must never be exploited in a reckless or dangerous manner, which could jeopardize the user’s safety or the safety of others.**

## ELECTRONIC BRAKE CONTROL SYSTEM

Your vehicle is equipped with an advanced electronic brake control system commonly referred to as ESC. This system includes Anti-Lock Brake System (ABS), Brake Assist System (BAS), Traction Control System (TCS), Electronic Roll Mitigation (ERM), Electronic Stability Control (ESC), and Trailer Sway Control (TSC). These systems work together to enhance both vehicle stability and control in various driving conditions.

### Anti-Lock Brake System (ABS)

The Anti-Lock Brake System (ABS) provides increased vehicle stability and brake performance under most braking conditions. The system automatically “pumps” the brakes during severe braking conditions to prevent wheel lock-up.

**STARTING AND OPERATING**

When the vehicle is driven over 7 mph (11 km/h), you may also hear a slight clicking sound as well as some related motor noises. These noises are the system performing its self check cycle to ensure that the ABS is working properly. This self check occurs each time the vehicle is started and accelerated past 7 mph (11 km/h).

ABS is activated during braking under certain road or stopping conditions. ABS-inducing conditions can include ice, snow, gravel, bumps, railroad tracks, loose debris, or panic stops.

You also may experience the following when the brake system goes into Anti-lock:

- The ABS motor running (it may continue to run for a short time after the stop),

- The clicking sound of solenoid valves,
- Brake pedal pulsations, and
- A slight drop or fall away of the brake pedal at the end of the stop.

These are all normal characteristics of ABS.

**WARNING!**

- **The ABS contains sophisticated electronic equipment that may be susceptible to interference caused by improperly installed or high output radio transmitting equipment. This interference can cause possible loss of anti-lock braking capability. Installation of such equipment should be performed by qualified professionals.**

- **Pumping of the Anti-Lock Brakes will diminish their effectiveness and may lead to an accident. Pumping makes the stopping distance longer. Just press firmly on your brake pedal when you need to slow down or stop.**
- **The ABS cannot prevent the natural laws of physics from acting on the vehicle, nor can it increase braking or steering efficiency beyond that afforded by the condition of the vehicle brakes and tires or the traction afforded.**
- **The ABS cannot prevent accidents, including those resulting from excessive speed in turns, following another vehicle too closely, or hydroplaning.**

## STARTING AND OPERATING

- **The capabilities of an ABS equipped vehicle must never be exploited in a reckless or dangerous manner, which could jeopardize the user's safety or the safety of others.**

All vehicle wheels and tires must be the same size and type and tires must be properly inflated to produce accurate signals for the computer.

### Anti-Lock Brake Light



The Anti-Lock Brake Light monitors the ABS. The light will turn on when the ignition switch is turned to the ON position and may stay on for as long as four seconds.

If the ABS Light remains on or comes on while driving, it indicates that the Anti-Lock portion of the brake system is not functioning and that service is required. However, the conventional brake system will continue to operate normally if the Brake System Warning Light is not on.

If the ABS Light is on, the brake system should be serviced as soon as possible to restore the benefits of Anti-Lock brakes. If the ABS Light does not come on when the ignition switch is turned to the ON position, have the light repaired as soon as possible.

If both the Brake System Warning Light and the ABS Light remain on, the ABS and Electronic Brake Force Distribution (EBD) systems are not functioning. Immediate repair to the ABS system is required.

### Brake Assist System (BAS)

The BAS is designed to optimize the vehicle's braking capability during emergency braking maneuvers. The system detects an emergency braking situation by sensing the rate and amount of brake application and then applies optimum pressure to the brakes. This can help reduce braking distances. The BAS complements the ABS. Applying the brakes very quickly results in the best BAS assistance. To receive the benefit of the system, you must apply continuous braking pressure during the stopping sequence, (do not "pump" the brakes). Do not reduce brake pedal pressure unless braking is no longer desired. Once the brake pedal is released, the BAS is deactivated.

## STARTING AND OPERATING

### WARNING!

**BAS cannot prevent the natural laws of physics from acting on the vehicle, nor can it increase the traction afforded by prevailing road conditions. BAS cannot prevent accidents, including those resulting from excessive speed in turns, driving on very slippery surfaces, or hydroplaning. The capabilities of a BAS-equipped vehicle must never be exploited in a reckless or dangerous manner, which could jeopardize the user's safety or the safety of others.**

### Traction Control System (TCS)

This system monitors the amount of wheel spin of each of the driven wheels. If wheel spin is detected, brake pressure is ap-

plied to the slipping wheel(s) and engine power is reduced to provide enhanced acceleration and stability. A feature of the TCS functions similar to a limited slip differential and controls the wheel spin across a driven axle. If one wheel on a driven axle is spinning faster than the other, the system will apply the brake of the spinning wheel. This will allow more engine torque to be applied to the wheel that is not spinning. This feature remains active even if TCS and ESC are in the "Partial Off" mode. Refer to "Electronic Stability Control (ESC)" in this section for more information.

### Electronic Roll Mitigation (ERM)

This system anticipates the potential for wheel lift by monitoring the driver's steering wheel input and the speed of the vehicle. When ERM determines that the

rate of change of the steering wheel angle and vehicle's speed are sufficient to potentially cause wheel lift, it then applies the appropriate brake and may also reduce engine power to lessen the chance that wheel lift will occur. ERM will only intervene during very severe or evasive driving maneuvers. ERM can only reduce the chance of wheel lift occurring during severe or evasive driving maneuvers. It cannot prevent wheel lift due to other factors, such as road conditions, leaving the roadway, or striking objects or other vehicles.

## STARTING AND OPERATING

### WARNING!

**Many factors, such as vehicle loading, road conditions, and driving conditions, influence the chance that wheel lift or rollover may occur. ERM cannot prevent all wheel lift or rollovers, especially those that involve leaving the roadway or striking objects or other vehicles. The capabilities of an ERM-equipped vehicle must never be exploited in a reckless or dangerous manner, which could jeopardize the user's safety or the safety of others.**

### Electronic Stability Control (ESC)

This system enhances directional control and stability of the vehicle under various driving conditions. ESC corrects for over-steering and under-steering the vehicle by

applying the brake of the appropriate wheel. Engine power may also be reduced to help the vehicle maintain the desired path.

The ESC uses sensors in the vehicle to determine the path that the driver intends to steer the vehicle and compares it to the actual path of the vehicle. When the actual path does not match the intended path, the ESC applies the brake of the appropriate wheel to assist in counteracting the condition of over-steer or under-steer.

- Over-steer - when the vehicle is turning more than appropriate for the steering wheel position.
- Under-steer - when the vehicle is turning less than appropriate for the steering wheel position.

### ESC Operating Modes

The ESC system has two available operating modes.

#### **Full On**

This is the normal operating mode for ESC. Whenever the vehicle is started the system will be in this mode. This mode should be used for most driving situations. ESC should only be turned to "Partial Off" for specific reasons as noted. Refer to "Partial Off" for additional information.

#### **Partial Off**

The "ESC OFF" button is located in the switch bank above the climate control. To enter the "Partial Off" mode, momentarily press the "ESC OFF" button and the "ESC Activation/Malfunction Indicator Light" will illuminate. To turn the ESC on again, momentarily press the "ESC OFF" button and the "ESC Activation/Malfunction Indicator

## STARTING AND OPERATING

Light" will turn off. This will restore the normal "ESC On" mode of operation.

art=054810808.tif NO TRANS



ESC OFF Button

**NOTE:** To improve the vehicle's traction when driving with snow chains, or when starting off in deep snow, sand, or gravel, it may be desirable to switch to the "Partial Off" mode by momentarily pressing the "ESC OFF" button. Once the situation requiring "Partial Off" mode is overcome,

turn ESC back on by momentarily pressing the "ESC OFF" button. This may be done while the vehicle is in motion.

### ESC Activation/Malfunction Indicator Light and ESC OFF Indicator Light

art=640433445.tif NO TRANS



The "ESC Activation/Malfunction Indicator Light" in the instrument cluster will come on when the ignition switch is turned to the ON position. It should go out with the engine running. If the "ESC Activation/Malfunction Indicator Light" comes on continuously with the engine running, a malfunction has been detected in the ESC system. If this light remains on after several ignition cycles, and the vehicle has been driven several miles (kilometers) at speeds greater than 30 mph (48 km/h), see your

authorized dealer as soon as possible to have the problem diagnosed and corrected.

The "ESC Activation/Malfunction Indicator Light" (located in the instrument cluster) starts to flash as soon as the tires lose traction and the ESC system becomes active. The "ESC Activation/Malfunction Indicator Light" also flashes when TCS is active. If the "ESC Activation/Malfunction Indicator Light" begins to flash during acceleration, ease up on the accelerator and apply as little throttle as possible. Be sure to adapt your speed and driving to the prevailing road conditions.

### NOTE:

- The "ESC Activation/Malfunction Indicator Light" and the "ESC OFF Indicator Light" come on momentarily each time the ignition switch is turned ON.

## STARTING AND OPERATING

- Each time the ignition is turned ON, the ESC system will be ON even if it was turned off previously.
- The ESC system will make buzzing or clicking sounds when it is active. This is normal; the sounds will stop when ESC becomes inactive following the maneuver that caused the ESC activation.

art=054807480.tif

NO TRANS



The "ESC OFF Indicator Light" indicates the Electronic Stability Control (ESC) is off.

### Trailer Sway Control (TSC)

TSC uses sensors in the vehicle to recognize an excessively swaying trailer. TSC activates automatically once the excessively swaying trailer is recognized. When TSC is functioning, the "ESC Activation/Malfunction Indicator Light" will flash, the

engine power will be reduced, and you will feel the brake being applied to individual wheels in an attempt to stop the trailer from swaying.

**NOTE:** The TSC is disabled when the ESC system is in the "Partial Off" mode.

### WARNING!

- **TSC cannot stop all trailers from swaying. Always use caution when towing a trailer and follow the tongue weight recommendations. Refer to "Vehicle Loading" and "Trailer Towing" in "Starting and Operating" for further information.**

- **If TSC activates while towing a trailer, stop the vehicle at the nearest safe location and adjust the trailer load to eliminate the trailer sway.**
- **Failure to follow these warnings can result in an accident or serious personal injury.**



**STARTING AND OPERATING**

**TIRE SAFETY INFORMATION**

**Tire Markings**

art=054903773.tif

NO TRANS

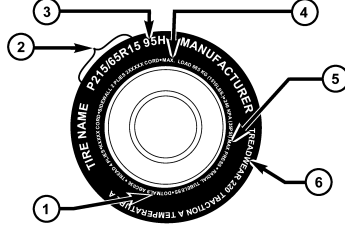

054903773

- |  |  |
|--|--|
| 1 — U.S. DOT Safety Standards Code (TIN) | 4 — Maximum Load                               |
| 2 — Size Designation                     | 5 — Maximum Pressure                           |
| 3 — Service Description                  | 6 — Treadwear, Traction and Temperature Grades |

**NOTE:**

- *P* (Passenger) - Metric tire sizing is based on U.S. design standards. *P*-Metric tires have the letter "P" molded into the sidewall preceding the size designation. Example: P215/65R15 95H.
- European-Metric tire sizing is based on European design standards. Tires designed to this standard have the tire size molded into the sidewall beginning with the section width. The letter "P" is absent from this tire size designation. Example: 215/65R15 96H.
- *LT* (Light Truck) - Metric tire sizing is based on U.S. design standards. The size designation for *LT*-Metric tires is the

same as for *P*-Metric tires except for the letters "LT" that are molded into the sidewall preceding the size designation. Example: LT235/85R16.

- Temporary spare tires are high-pressure compact spares designed for temporary emergency use only. Tires designed to this standard have the letter "T" molded into the sidewall preceding the size designation. Example: T145/80D18 103M.
- High flotation tire sizing is based on U.S. design standards, and it begins with the tire diameter molded into the sidewall. Example: 31x10.5 R15 LT.

**STARTING AND OPERATING**

**Tire Sizing Chart**

<b>TIRE SIZING TERMS</b>	
<b>Size Designation:</b>	
<p><b>P</b> = Passenger Car tire size based on U.S. design standards                      "...blank..." = Passenger Car tire based on European design standards  <b>LT</b> = Light Truck tire based on U.S. design standards  <b>T</b> = Temporary spare tire  <b>31</b> = Overall diameter in inches (in)</p>	
<p><b>215</b> = Section width in millimeters (mm)</p>	
<p><b>65</b> = Aspect ratio in percent (%)                      — Ratio of section height to section width of tire  <b>10.5</b> = Section width in inches (in)</p>	
<p><b>R</b> = Construction code                      — "R" means radial construction                      — "D" means diagonal or bias construction</p>	
<p><b>15</b> = Rim diameter in inches (in)</p>	
<b>Service Description:</b>	

**STARTING AND OPERATING**

<b>TIRE SIZING TERMS</b>	
<b>95</b> = Load Index	— A numerical code associated with the maximum load a tire can carry
<b>H</b> = Speed Symbol	— A symbol indicating the range of speeds at which a tire can carry a load corresponding to its load index under certain operating conditions — The maximum speed corresponding to the speed symbol should only be achieved under specified operating conditions (i.e., tire pressure, vehicle loading, road conditions, and posted speed limits)
<b>Load Identification:</b>	
	"....blank...." = Absence of any text on the sidewall of the tire indicates a Standard Load (SL) Tire
	<b>Extra Load (XL)</b> = Extra load (or reinforced) tire
	<b>Light Load</b> = Light load tire
	<b>C, D, E</b> = Load range associated with the maximum load a tire can carry at a specified pressure
	<b>Maximum Load</b> — Maximum load indicates the maximum load this tire is designed to carry
	<b>Maximum Pressure</b> — Maximum pressure indicates the maximum permissible cold tire inflation pressure for this tire

**Tire Identification Number (TIN)**

The TIN may be found on one or both sides of the tire, however, the date code may only be on one side. Tires with white sidewalls will have the full TIN, including the date code, located on the white sidewall side of the tire. Look for the TIN on the outboard side

**STARTING AND OPERATING**

of black sidewall tires as mounted on the vehicle. If the TIN is not found on the outboard side, then you will find it on the inboard side of the tire.

<b>TIRE IDENTIFICATION NUMBER</b>
<b>EXAMPLE: DOT MA L9 ABCD 0301</b>
<b>DOT</b> = Department of Transportation — This symbol certifies that the tire is in compliance with the U.S. Department of Transportation tire safety standards, and is approved for highway use
<b>MA</b> = Code representing the tire manufacturing location (two digits)
<b>L9</b> = Code representing the tire size (two digits)
<b>ABCD</b> = Code used by the tire manufacturer (one to four digits)
<b>03</b> = Number representing the week in which the tire was manufactured (two digits) —03 means the 3rd week.
<b>01</b> = Number representing the year in which the tire was manufactured (two digits) —01 means the year 2001 — Prior to July 2000, tire manufacturers were only required to have one number to represent the year in which the tire was manufactured. Example: 031 could represent the 3rd week of 1981 or 1991

**Tire Terminology and Definitions**

**STARTING AND OPERATING**

<b>Term</b>	<b>Definition</b>
<b>B-Pillar</b>	The vehicle B-Pillar is a structural member of the body located between the front and rear door (of a four-door vehicle) running from the sill to the roof.
<b>Cold Tire Pressure</b>	Cold tire inflation pressure is defined as the tire pressure after the vehicle has not been driven for at least 3 hours, or driven less than 1 mile (1.6 km) after sitting for a three hour period. Inflation pressure is measured in units of PSI (pounds per square inch) or KPa (kilopascals).
<b>Maximum Inflation Pressure</b>	The maximum inflation pressure is the maximum permissible cold tire inflation pressure for this tire. The max inflation pressure is molded into the sidewall.
<b>Recommended Inflation Pressure</b>	Vehicle manufacturer's recommended tire inflation pressure as shown on the tire placard.
<b>Tire Placard</b>	A paper label permanently attached to the vehicle showing the vehicle's loading capacity, the original equipment tire size and the recommended inflation pressure.

**STARTING AND OPERATING**

**Tire Loading And Tire Pressure**

**Tire Placard Location**

**NOTE:** *The proper cold tire inflation pressure is listed on the driver's side B-Pillar.*

**Tire and Loading Information Placard**

art=054907701.tif NO TRANS

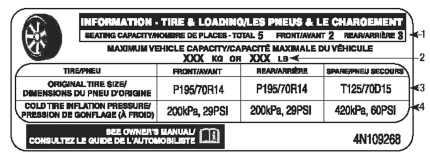

054907701

**Tire and Loading Information Placard**

This placard tells you important information about the:

- 1) number of people that can be carried in the vehicle
- 2) total weight your vehicle can carry
- 3) tire size designed for your vehicle
- 4) cold tire inflation pressures for the front, rear, and spare tires.

**Loading**

The vehicle maximum load on the tire must not exceed the load carrying capacity of the tire on your vehicle. You will not exceed the tire's load carrying capacity if you adhere to the loading conditions, tire size, and cold tire inflation pressures specified on the Tire and Loading Information placard and in the "Vehicle Loading" section of this manual.

**NOTE:** *Under a maximum loaded vehicle condition, gross axle weight ratings (GAWRs) for the front and rear axles must*

*not be exceeded. For further information on GAWRs, vehicle loading, and trailer towing, refer to "Vehicle Loading" in this section.*

To determine the maximum loading conditions of your vehicle, locate the statement "The combined weight of occupants and cargo should never exceed XXX kg or XXX lbs." on the Tire and Loading Information placard. The combined weight of occupants, cargo/luggage and trailer tongue weight (if applicable) should never exceed the weight referenced here.

**Steps For Determining Correct Load Limit**

1. Locate the statement "The combined weight of occupants and cargo should never exceed XXX kg or XXX lbs" on your vehicle's placard.

---

## STARTING AND OPERATING

2. Determine the combined weight of the driver and passengers that will be riding in your vehicle.

3. Subtract the combined weight of the driver and passengers from XXX kg or XXX lbs.

4. The resulting figure equals the available amount of cargo and luggage load capacity. For example, if "XXX" amount equals 1,400 lbs (635 kg) and there will be five 150 lb (68 kg) passengers in your vehicle, the amount of available cargo and luggage load capacity is 650 lbs (295 kg) (since  $5 \times 150 = 750$ , and  $1400 - 750 = 650$  lbs [295 kg]).

5. Determine the combined weight of luggage and cargo being loaded on the vehicle. That weight may not safely ex-

ceed the available cargo and luggage load capacity calculated in Step 4.

6. If your vehicle will be towing a trailer, load from your trailer will be transferred to your vehicle. Consult this manual to determine how this reduces the available cargo and luggage load capacity of your vehicle.

**NOTE:** *The following table shows examples on how to calculate total load, cargo/luggage, and towing capacities of your vehicle with varying seating configurations and number and size of occupants. This table is for illustration purposes only and may not be accurate for the seating and load carry capacity of your vehicle.*

**NOTE:** *For the following example, the combined weight of occupants and cargo*

*should never exceed 865 lbs (392 kg).*

**STARTING AND OPERATING**

art=054900419.tif NO TRANS

Occupants			Combined weight of occupants and cargo from Tire Placard	MINUS	Combined Occupant's weight	=	AVAILABLE Cargo/Luggage and Trailer Tongue Weight
TOTAL	FRONT	REAR					
<b>EXAMPLE 1</b>			865 lbs	minus	670 lbs	=	195 lbs
5	2	3					
<b>EXAMPLE 2</b>			865 lbs	minus	540 lbs	=	325 lbs
3	2	1					
<b>EXAMPLE 3</b>			865 lbs	minus	400 lbs	=	465 lbs
2	2	0					

EXAMPLE

Occupant 1: 200 lbs  
 Occupant 2: 130 lbs  
 Occupant 3: 160 lbs  
 Occupant 4: 100 lbs  
 Occupant 5: 80 lbs  
 TOTAL WEIGHT: 670 lbs

Occupant 1: 210 lbs  
 Occupant 2: 180 lbs  
 Occupant 3: 150 lbs  
 TOTAL WEIGHT: 540 lbs

Occupant 1: 200 lbs  
 Occupant 2: 200 lbs  
 TOTAL WEIGHT: 400 lbs

811a4d11



**STARTING AND OPERATING**

**WARNING!**

Overloading of your tires is dangerous. Overloading can cause tire failure, affect vehicle handling, and increase your stopping distance. Use tires of the recommended load capacity for your vehicle. Never overload them.

**TIRES — GENERAL INFORMATION**

**Tire Pressure**

Proper tire inflation pressure is essential to the safe and satisfactory operation of your vehicle. Three primary areas are affected by improper tire pressure:

**Safety**

**WARNING!**

- Improperly inflated tires are dangerous and can cause collisions.
- Under-inflation increases tire flexing and can result over-heating and in tire failure.
- Over-inflation reduces a tire's ability to cushion shock. Objects on the road and chuckholes can cause damage that result in tire failure.
- Unequal tire pressures can cause steering problems. You could lose control of your vehicle.
- Over-inflated or under-inflated tires can affect vehicle handling and can fail suddenly, resulting in loss of vehicle control.

- Unequal tire pressures from one side of the vehicle to the other can cause the vehicle to drift to the right or left.
- Always drive with each tire inflated to the recommended cold tire inflation pressure.

**Economy**

Improper inflation pressures can cause uneven wear patterns to develop across the tire tread. These abnormal wear patterns will reduce tread life resulting in a need for earlier tire replacement. Under-inflation, also increases tire rolling resistance and results in higher fuel consumption.

## STARTING AND OPERATING

### Ride Comfort and Vehicle Stability

Proper tire inflation contributes to a comfortable ride. Over-inflation produces a jarring and uncomfortable ride.

### Tire Inflation Pressures

The proper cold tire inflation pressure is listed on the driver's side B-Pillar.

Some vehicles may have Supplemental Tire Pressure Information for vehicle loads that are less than the maximum loaded vehicle condition. These pressure conditions will be found in the "Supplemental Tire Pressure Information" section of this manual.

The pressure should be checked and adjusted as well as inspecting for signs of tire wear or visible damage at least once a month. Use a good quality pocket-type gauge to check tire pressure. Do not make

a visual judgement when determining proper inflation. Radial tires may look properly inflated even when they are under-inflated.

#### CAUTION!

**After inspecting or adjusting the tire pressure, always reinstall the valve stem cap. This will prevent moisture and dirt from entering the valve stem, which could damage the valve stem.**

Inflation pressures specified on the placard are always "cold tire inflation pressure." Cold tire inflation pressure is defined as the tire pressure after the vehicle has not been driven for at least three hours, or driven less than 1 mile (1.6 km) after a three hour period. The cold tire inflation pressure must not exceed the

maximum inflation pressure molded into the tire sidewall.

Check tire pressures more often if subject to a wide range of outdoor temperatures, as tire pressures vary with temperature changes.

Tire pressures change by approximately 1 psi (7 kPa) per 12°F (7°C) of air temperature change. Keep this in mind when checking tire pressure inside a garage, especially in the winter.

Example: If garage temperature = 68°F (20°C) and the outside temperature = 32°F (0°C) then the cold tire inflation pressure should be increased by 3 psi (21 kPa), which equals 1 psi (7 kPa) for every 12°F (7°C) for this outside temperature condition.

**STARTING AND OPERATING**

Tire pressure may increase from 2 to 6 psi (13 to 40 kPa) during operation. DO NOT reduce this normal pressure build up or your tire pressure will be too low.

**Tire Pressures For High Speed Operation**

The manufacturer advocates driving at safe speeds within posted speed limits. Where speed limits or conditions are such that the vehicle can be driven at high speeds, maintaining correct tire inflation pressure is very important. Increased tire pressure and reduced vehicle loading may be required for high-speed vehicle operation. Refer to original equipment or an authorized tire dealer for recommended safe operating speeds, loading and cold tire inflation pressures.

**WARNING!**

**High speed driving with your vehicle under maximum load is dangerous. The added strain on your tires could cause them to fail. You could have a serious collision. Do not drive a vehicle loaded to the maximum capacity at continuous speeds above 75 mph (120 km/h).**

**Radial-Ply Tires**

**WARNING!**

**Combining radial ply tires with other types of tires on your vehicle will cause your vehicle to handle poorly. The instability could cause a collision. Always use radial ply tires in sets of four. Never combine them with other types of tires.**

Cuts and punctures in radial tires are repairable only in the tread area because of sidewall flexing. Consult your authorized tire dealer for radial tire repairs.

## STARTING AND OPERATING

### **Spare Tire Matching Original Equipped Tire and Wheel – If Equipped**

The spare tire of your vehicle is equivalent in look and function as the original equipment tire and wheel found on the front or rear axle of your vehicle. This spare tire may be used in the tire rotation for your vehicle. If your vehicle has an option for a spare tire matching original equipment tire and wheel, refer to the recommended tire rotation pattern in "Tire Rotation Recommendations" in "Starting and Operating" for further information.

If your vehicle is not equipped with an original equipment tire and wheel as a spare, a non-matching temporary emergency use spare may be equipped with your vehicle. Temporary use spares are engineered to be used only with your vehicle. Your vehicle may be equipped

with one of the following types of non-matching temporary use spares; compact, full size, or limited-use.

Do not install more than one non-matching temporary use spare tire/wheel on the vehicle at any given time.

#### **CAUTION!**

**Because of the reduced ground clearance, do not take your vehicle through an automatic car wash with a compact, full size or limited-use temporary spare installed. Damage to the vehicle may result.**

### **Compact Spare Tire – If Equipped**

The compact spare is for temporary emergency use only. You can identify if your vehicle is equipped with a compact spare

by looking at the spare tire description on the Tire and Loading Information Placard located on the driver's side door opening or on the sidewall of the tire. Compact spare tire descriptions begin with the letter "T" or "S" preceding the size designation. Example: T145/80D18 103M.

T, S = Temporary Spare Tire

Since this tire has limited tread life the original equipment tire should be repaired (or replaced) and reinstalled on your vehicle at the first opportunity.

Do not install a wheel cover or attempt to mount a conventional tire on the compact spare wheel, since the wheel is designed specifically for the compact spare. Do not install more than one compact spare tire/wheel on the vehicle at any given time

## STARTING AND OPERATING

### WARNING!

**Compact spares are for temporary emergency use only. With these spares, do not drive more than 50 mph (80 km/h). Temporary use spares have limited tread life. When the tread is worn to the tread wear indicators, the temporary use spare tire needs to be replaced. Be sure to follow the warnings, which apply to your spare. Failure to do so could result in spare tire failure and loss of vehicle control.**

### Full Size Spare – If Equipped

The full size spare is for temporary emergency use only. This tire may look like the original equipped tire on the front or rear axle of your vehicle, but it is not. This spare tire may have limited tread life.

When the tread is worn to the tread wear indicators, the temporary use full size spare tire needs to be replaced. Since it is not the same as your original equipment tire, replace (or repair) the original equipment tire and reinstall on the vehicle at the first opportunity.

### Limited-Use Spare – If Equipped

The limited-use spare tire is for temporary emergency use only. This tire is identified by a label located on the limited-use spare wheel. This label contains the driving limitations for this spare. This tire may look like the original equipped tire on the front or rear axle of your vehicle, but it is not. Installation of this limited-use spare tire affects vehicle handling. Since it is not the same as your original equipment tire, re-

place (or repair) the original equipment tire and reinstall on the vehicle at the first opportunity.

### WARNING!

**Limited-use spares are for emergency use only. Installation of this limited-use spare tire affects vehicle handling. With this tire, do not drive more than the speed listed on the limit-use spare wheel. Keep inflated to the cold tire inflation pressure listed on your Tire and Loading Information Placard located on the driver's side door opening. Replace (or repair) the original equipment tire at the first opportunity and reinstall it on your vehicle. Failure to do so could result in loss of vehicle control.**

## STARTING AND OPERATING

### Tire Spinning

When stuck in mud, sand, snow, or icy conditions, do not spin your vehicle's wheels faster than 30 mph (48 km/h) or for longer than 30 seconds continuously without stopping.

Refer to "Freeing A Stuck Vehicle" in "What To Do In Emergencies" for further information.

### WARNING!

**Fast spinning tires can be dangerous. Forces generated by excessive wheel speeds may cause tire damage or failure. A tire could explode and injure someone. Do not spin your vehicle's wheels faster than 30 mph (48 km/h) or for more than 30 seconds continuously when you are stuck, and do not let anyone near a spinning wheel, no matter what the speed.**

### Tread Wear Indicators

Tread wear indicators are in the original equipment tires to help you in determining when your tires should be replaced.

art=055007576.tif NO TRANS

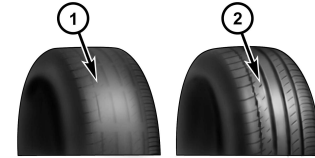

055007576

- 1 — Worn Tire
- 2 — New Tire

These indicators are molded into the bottom of the tread grooves. They will appear as bands when the tread depth becomes 1/16 in (2 mm). When the tread is worn to the tread wear indicators, the tire should be replaced.

## STARTING AND OPERATING

### Life Of Tire

The service life of a tire is dependent upon varying factors including but not limited to:

- Driving style
- Tire pressure
- Distance driven

### WARNING!

**Tires and spare tire should be replaced after six years, regardless of the remaining tread. Failure to follow this warning can result in sudden tire failure. You could lose control and have a collision resulting in serious injury or death.**

Keep dismantled tires in a cool, dry place with as little exposure to light as possible. Protect tires from contact with oil, grease, and gasoline.

### Replacement Tires

The tires on your new vehicle provide a balance of many characteristics. They should be inspected regularly for wear and correct cold tire inflation pressure. The manufacturer strongly recommends that you use tires equivalent to the originals in size, quality and performance when replacement is needed (refer to the paragraph on "Tread Wear Indicators"). Refer to the "Tire and Loading Information" placard for the size designation of your tire. The service description and load identification will be found on the original equipment tire. Failure to use equivalent replacement tires may adversely affect the

safety, handling, and ride of your vehicle. We recommend that you contact your original equipment or an authorized tire dealer with any questions you may have on tire specifications or capability.

## STARTING AND OPERATING

### WARNING!

- Do not use a tire, wheel size or rating other than that specified for your vehicle. Some combinations of unapproved tires and wheels may change suspension dimensions and performance characteristics, resulting in changes to steering, handling, and braking of your vehicle. This can cause unpredictable handling and stress to steering and suspension components. You could lose control and have a collision resulting in serious injury or death. Use only the tire and wheel sizes with load ratings approved for your vehicle.

- Never use a tire with a smaller load index or capacity, other than what was originally equipped on your vehicle. Using a tire with a smaller load index could result in tire overloading and failure. You could lose control and have a collision.
- Failure to equip your vehicle with tires having adequate speed capability can result in sudden tire failure and loss of vehicle control.

### CAUTION!

Replacing original tires with tires of a different size may result in false speedometer and odometer readings.

### TIRE CHAINS

Use only compact chains, or other traction aids that meet SAE type "Class S" specifications. Chains must be the proper size for the vehicle, as recommended by the chain manufacturer.

**NOTE:** Do not use tire chains on a compact spare tire.

### CAUTION!

To avoid damage to your vehicle or tires, observe the following precautions:

- Use chains on 215/65R16 tires only.



## STARTING AND OPERATING

- **Because of restricted chain clearance between tires and other suspension components, it is important that only chains in good condition are used. Broken chains can cause serious damage. Stop the vehicle immediately if noise occurs that could indicate chain breakage. Remove the damaged parts of the chain before further use.**
- **Do not exceed 45 mph (70 km/h).**
- **Drive cautiously and avoid severe turns and large bumps, especially with a loaded vehicle.**
- **Install chains on the front wheels as tightly as possible and then retighten after driving about 0.5 mile (0.8 km).**

- **Do not drive for prolonged periods of time on dry pavement.**
- **Observe the tire chain manufacturer's instructions on the method of installation, operating speed, and conditions for use. Always use the lower suggested operating speed of the chain manufacturer, if different from the speed recommended by the vehicle manufacturer.**

Always use the lower suggested operating speed if the chain manufacturer and vehicle manufacturer suggest different maximum speeds. This notice applies to all chain traction devices, including link and cable (radial) chains.

### SNOW TIRES

Some areas of the country require the use of snow tires during the winter. All season

tires satisfy this requirement and can be identified by the M+S designation on the tire sidewall.

If you need snow tires, select tires equivalent in size and type to the original equipment tires. Use snow tires only in sets of four; failure to do so may adversely affect the safety and handling of your vehicle.

Snow tires generally have lower speed ratings than what was originally equipped with your vehicle and should not be operated at sustained speeds over 75 mph (120 km/h). For speeds above 75 mph (120 km/h) refer to original equipment or an authorized tire dealer for recommended safe operating speeds, loading and cold tire inflation pressures.

While studded tires improve performance on ice, skid and traction capability on wet

## STARTING AND OPERATING

or dry surfaces may be poorer than that of non-studded tires. Some states prohibit studded tires; therefore, local laws should be checked before using these tire types.

### TIRE ROTATION RECOMMENDATIONS

Tires on the front and rear axles of vehicles operate at different loads and perform different steering, driving, and braking functions. For these reasons, they wear at unequal rates.

These effects can be reduced by timely rotation of tires. The benefits of rotation are especially worthwhile with aggressive tread designs such as those on all season type tires. Rotation will increase tread life, help to maintain mud, snow and wet traction levels, and contribute to a smooth, quiet ride.

Refer to the "Maintenance Schedule" for the proper maintenance intervals. The reasons for any rapid or unusual wear should be corrected prior to rotation being performed.

The suggested rotation method is the "rearward cross" shown in the following diagram. This rotation pattern does not apply to some directional tires that must not be reversed.

art=055707139.tif NO TRANS

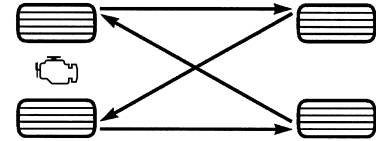

055707139

Tire Rotation

### TIRE PRESSURE MONITOR SYSTEM (TPMS)

The Tire Pressure Monitor System (TPMS) will warn the driver of a low tire pressure based on the vehicle recommended cold placard pressure.

The tire pressure will vary with temperature by about 1 psi (6.9 kPa) for every 12°F (6.5°C). This means that when the outside

---

## STARTING AND OPERATING

temperature decreases, the tire pressure will decrease. Tire pressure should always be set based on cold inflation tire pressure. This is defined as the tire pressure after the vehicle has not been driven for at least three hours, or driven less than 1 mile (1.6 km) after a three hour period. The cold tire inflation pressure must not exceed the maximum inflation pressure molded into the tire sidewall. Refer to "Tires – General Information" in "Starting and Operating" for information on how to properly inflate the vehicle's tires. The tire pressure will also increase as the vehicle is driven. This is normal and there should be no adjustment for this increased pressure.

The TPMS will warn the driver of a low tire pressure if the tire pressure falls below the low-pressure warning limit for any reason,

including low temperature effects and natural pressure loss through the tire.

The TPMS will continue to warn the driver of low tire pressure as long as the condition exists, and will not turn off until the tire pressure is at or above the recommended cold placard pressure. Once the low tire pressure warning (Tire Pressure Monitoring Telltale Light) illuminates, you must increase the tire pressure to the recommended cold placard pressure in order for the "Tire Pressure Monitoring Telltale Light" to turn off. The system will automatically update and the "Tire Pressure Monitoring Telltale Light" will turn off once the system receives the updated tire pressures. The vehicle may need to be driven for up to 20 minutes above 15 mph (24 km/h) in order for the TPMS to receive this information.

For example, your vehicle may have a recommended cold (parked for more than three hours) placard pressure of 33 psi (227 kPa). If the ambient temperature is 68°F (20°C) and the measured tire pressure is 28 psi (193 kPa), a temperature drop to 20°F (-7°C) will decrease the tire pressure to approximately 24 psi (165 kPa). This tire pressure is low enough to turn ON the "Tire Pressure Monitoring Telltale Light." Driving the vehicle may cause the tire pressure to rise to approximately 28 psi (193 kPa), but the "Tire Pressure Monitoring Telltale Light" will still be on. In this situation, the "Tire Pressure Monitoring Telltale Light" will turn off only after the tires are inflated to the vehicle's recommended cold placard pressure value.

## STARTING AND OPERATING

### CAUTION!

- The TPMS has been optimized for the original equipment tires and wheels. TPMS pressures and warning have been established for the tire size equipped on your vehicle. Undesirable system operation or sensor damage may result when using replacement equipment that is not of the same size, type, and/or style. Aftermarket wheels can cause sensor damage. Do not use aftermarket tire sealants or balance beads if your vehicle is equipped with a TPMS, as damage to the sensors may result.

- After inspecting or adjusting the tire pressure, always reinstall the valve stem cap. This will prevent moisture and dirt from entering the valve stem, which could damage the Tire Pressure Monitoring Sensor.

### NOTE:

- The TPMS is not intended to replace normal tire care and maintenance, or to provide warning of a tire failure or condition.
- The TPMS should not be used as a tire pressure gauge while adjusting your tire pressure.
- Driving on a significantly under-inflated tire causes the tire to overheat and can lead to tire failure. Under-inflation also

*reduces fuel efficiency and tire tread life, and may affect the vehicle's handling and stopping ability.*

- *The TPMS is not a substitute for proper tire maintenance, and it is the driver's responsibility to maintain correct tire pressure using an accurate tire pressure gauge, even if under-inflation has not reached the level to trigger illumination of the "Tire Pressure Monitoring Telltale Light."*
- *Seasonal temperature changes will affect tire pressure, and the TPMS will monitor the actual tire pressure in the tire.*

### Base System

The Tire Pressure Monitor System (TPMS) uses wireless technology with wheel rim mounted electronic sensors to monitor tire

## STARTING AND OPERATING

pressure levels. Sensors, mounted to each wheel as part of the valve stem, transmit tire pressure readings to the receiver module.

**NOTE:** *It is particularly important for you to check the tire pressure in all of the tires on your vehicle monthly and to maintain the proper pressure.*

The TPMS consists of the following components:

- Receiver Module
- Four Tire Pressure Monitoring Sensors
- Tire Pressure Monitoring Telltale Light

### Tire Pressure Monitoring Low

#### Pressure Warnings



The "Tire Pressure Monitoring Telltale Light" will illuminate in the in-

strument cluster, a "LOW TIRE" message will be displayed and a chime will sound when tire pressure is low in one or more of the four active road tires. Should this occur, you should stop as soon as possible, check the inflation pressure of each tire on your vehicle, and inflate each tire to the vehicle's recommended cold placard pressure value. Once the system receives the updated tire pressures, the system will automatically update and the "Tire Pressure Monitoring Telltale Light" and "LOW TIRE" message will turn off. The vehicle may need to be driven for up to 20 minutes above 15 mph (24 km/h) in order for the TPMS to receive this information.

### Service TPMS Warning

When a system fault is detected, the "Tire Pressure Monitoring Telltale Light" will flash on and off for 75 seconds and then

remain on solid. The system fault will also sound a chime. If the ignition switch is cycled, this sequence will repeat, providing the system fault still exists. The "Tire Pressure Monitoring Telltale Light" will turn off when the fault condition no longer exists. A system fault can occur due to any of the following:

1. Jamming due to electronic devices or driving next to facilities emitting the same Radio Frequencies as the TPMS sensors.
2. Installing some form of aftermarket window tinting that affects radio wave signals.
3. Lots of snow or ice around the wheels or wheel housings.
4. Using tire chains on the vehicle.
5. Using wheels/tires not equipped with TPMS sensors.

## STARTING AND OPERATING

### NOTE:

1. The compact spare tire does not have a tire pressure monitoring sensor. Therefore, the TPMS will not monitor the pressure in the compact spare tire.

2. If you install the compact spare tire in place of a road tire that has a pressure below the low-pressure warning limit, a chime will sound and the "Tire Pressure Monitoring Telltale Light" will turn on and a "LOW TIRE" message will be displayed for a minimum of five seconds upon the next ignition switch cycle.

3. After driving the vehicle for up to 20 minutes above 15 mph (24 km/h), the "Tire Pressure Monitoring Telltale Light" will flash on and off for 75 seconds and then remain on solid.

4. For each subsequent ignition switch cycle, a chime will sound and the "Tire Pressure Monitoring Telltale Light" will flash on and off for 75 seconds and then remain on solid.

5. Once you repair or replace the original road tire and reinstall it on the vehicle in place of the compact spare, the TPMS will update automatically and the "Tire Pressure Monitoring Telltale Light" will turn off, as long as no tire pressure is below the low-pressure warning limit in any of the four active road tires. The vehicle may need to be driven for up to 20 minutes above 15 mph (24 km/h) in order for the TPMS to receive this information.

### Premium System – If Equipped

The Tire Pressure Monitor System (TPMS) uses wireless technology with wheel rim mounted electronic sensors to monitor tire

pressure levels. Sensors, mounted to each wheel as part of the valve stem, transmit tire pressure readings to the receiver module.

**NOTE:** It is particularly important for you to check the tire pressure in all of the tires on your vehicle monthly and to maintain the proper pressure.

The TPMS consists of the following components:

- Receiver module
- Four Tire Pressure Monitoring Sensors
- Various Tire Pressure Monitoring System messages, which display in the Electronic Vehicle Information Center (EVIC)
- Tire Pressure Monitoring Telltale Light

**STARTING AND OPERATING**

**Tire Pressure Monitoring Low Pressure Warnings**



art=055900258.tif

NO TRANS

The “Tire Pressure Monitoring Telltale Light” will illuminate in the instrument cluster and a chime will sound when tire pressure is low in one or more of the four active road tires. In addition, the Electronic Vehicle Information Center (EVIC) will display a graphic showing the pressure values of each tire with the low tire pressure values flashing.

art=055800612.tif

NO TRANS

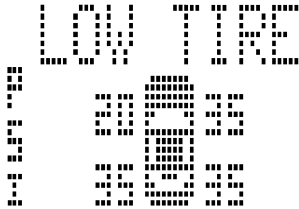

81826bed

Should this occur, you should stop as soon as possible and inflate the tires with low pressure (those flashing in the EVIC graphic) to the vehicle’s recommended cold placard pressure value. Once the system receives the updated tire pressures, the system will automatically update, the graphic display in the EVIC will stop flashing, and the “Tire Pressure Monitoring Telltale Light” will turn off. The vehicle may need to be driven for up to 20 minutes above 15 mph (24 km/h) in order for the TPMS to receive this information.

**Service TPMS Warning**

When a system fault is detected, the “Tire Pressure Monitoring Telltale Light” will flash on and off for 75 seconds and then remain on solid. The system fault will also sound a chime. In addition, the EVIC will

display a “SERVICE TPM SYSTEM” message for a minimum of five seconds and then display dashes (- -) in place of the pressure value to indicate which sensor is not being received.

art=055800613.tif

NO TRANS

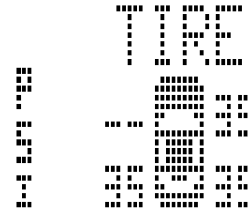

81826bd7

If the ignition switch is cycled, this sequence will repeat, providing the system fault still exists. If the system fault no longer exists, the “Tire Pressure Monitoring Telltale Light” will no longer flash, and

## STARTING AND OPERATING

the "SERVICE TPM SYSTEM" message will no longer display, and a pressure value will display in place of the dashes. A system fault can occur due to any of the following:

1. Jamming due to electronic devices or driving next to facilities emitting the same radio frequencies as the TPMS sensors.
2. Installing some form of aftermarket window tinting that affects radio wave signals.
3. Lots of snow or ice around the wheels or wheel housings.
4. Using tire chains on the vehicle.
5. Using wheels/tires not equipped with TPMS sensors.

The EVIC will also display a "SERVICE TPM SYSTEM" message for a minimum of

five seconds when a system fault related to an incorrect sensor location fault is detected. In this case, the "SERVICE TPM SYSTEM" message is then followed with a graphic display with pressure values still shown. This indicates that the pressure values are still being received from the TPM sensors but they may not be located in the correct vehicle position. The system still needs to be serviced as long as the "SERVICE TPM SYSTEM" message is displayed.

### NOTE:

1. *The compact spare tire does not have a tire pressure monitoring sensor. Therefore, the TPMS will not monitor the pressure in the compact spare tire.*
2. *If you install the compact spare tire in place of a road tire that has a pressure below the low-pressure warning limit,*

*upon the next ignition switch cycle, the "Tire Pressure Monitoring Telltale Light" will remain on and a chime will sound. In addition, the graphic in the EVIC will still display a flashing pressure value.*

*3. After driving the vehicle for up to 20 minutes above 15 mph (24 km/h), the "Tire Pressure Monitoring Telltale Light" will flash on and off for 75 seconds and then remain on solid. In addition, the EVIC will display a "SERVICE TPM SYSTEM" message for a minimum of five seconds and then display dashes (- -) in place of the pressure value.*

*4. For each subsequent ignition switch cycle, a chime will sound, the "Tire Pressure Monitoring Telltale Light" will flash on and off for 75 seconds and then remain on*



**STARTING AND OPERATING**

solid, and the EVIC will display a "SERVICE TPM SYSTEM" message for a minimum of five seconds and then display dashes (- -) in place of the pressure value.

5. Once you repair or replace the original road tire and reinstall it on the vehicle in place of the compact spare, the TPMS will update automatically. In addition, the "Tire Pressure Monitoring Telltale Light" will turn off and the graphic in the EVIC will display a new pressure value instead of dashes (- -), as long as no tire pressure is below the low-pressure warning limit in any of the four active road tires. The vehicle may need to be driven for up to 20 minutes above 15 mph (24 km/h) in order for the TPMS to receive this information.

**General Information**

This device complies with Part 15 of the FCC rules and RSS 210 of Industry

Canada. Operation is subject to the following conditions:

- This device may not cause harmful interference.
- This device must accept any interference received, including interference that may cause undesired operation.

The tire pressure sensors are covered under one of the following licenses:

- United States. . . . . MRXC4W4MA4
- Canada. . . . . 2546A-C4W4MA4

**FUEL REQUIREMENTS**

art=056202032.tif

NO TRANS



This engine is designed to meet all emissions regulations and provide excellent fuel economy and performance when using high-quality unleaded "regular" gasoline having an octane rating of 87. The use of premium gasoline is not recommended, as it will not provide any benefit over regular gasoline in these engines.

Light spark knock at low engine speeds is not harmful to your engine. However, continued heavy spark knock at high speeds can cause damage and immediate service is required. Poor quality gasoline can cause problems such as hard starting, stalling, and hesitations. If you experience

## STARTING AND OPERATING

these symptoms, try another brand of gasoline before considering service for the vehicle.

Over 40 auto manufacturers worldwide have issued and endorsed consistent gasoline specifications (the Worldwide Fuel Charter, WWFC) which define fuel properties necessary to deliver enhanced emissions, performance, and durability for your vehicle. The manufacturer recommends the use of gasolines that meet the WWFC specifications if they are available.

### Reformulated Gasoline

Many areas of the country require the use of cleaner burning gasoline referred to as "Reformulated Gasoline." Reformulated gasoline contains oxygenates and are specifically blended to reduce vehicle emissions and improve air quality.

The manufacturer supports the use of reformulated gasoline. Properly blended reformulated gasoline will provide excellent performance and durability of engine and fuel system components.

### Gasoline/Oxygenate Blends

Some fuel suppliers blend unleaded gasoline with oxygenates such as Ethanol. Fuels blended with oxygenates may be used in your vehicle.

### CAUTION!

**DO NOT use gasoline containing Methanol or gasoline containing more than 10% Ethanol. Use of these blends may result in starting and driveability problems, damage critical fuel system components, cause emissions to exceed the applicable standard, and/or cause the "Malfunction Indicator Light" to illuminate. Pump labels should clearly communicate if a fuel contains greater than 10% Ethanol.**

Problems that result from using gasoline containing Methanol or gasoline containing more than 10% Ethanol are not the responsibility of the manufacturer and may not be covered under warranty.

---

## STARTING AND OPERATING

### **E-85 Usage In Non-Flex Fuel Vehicles**

Non-FFV vehicles are compatible with gasoline containing 10% ethanol (E10). Gasoline with higher ethanol content may void the vehicle's warranty.

If a Non-FFV vehicle is inadvertently fueled with E-85 fuel, the engine will have some or all of these symptoms:

- operate in a lean mode
- OBD II "Malfunction Indicator Light" on
- poor engine performance
- poor cold start and cold driveability
- increased risk for fuel system component corrosion

To fix a Non-FFV vehicle inadvertently fueled once with E-85 perform the following:

- change the engine oil and oil filter
- disconnect and reconnect the battery
- drain the fuel tank (see your authorized dealer)

More extensive repairs will be required for prolonged exposure to E-85 fuel.

### **MMT In Gasoline**

MMT is a manganese-containing metallic additive that is blended into some gasoline to increase octane. Gasoline blended with MMT provides no performance advantage beyond gasoline of the same octane number without MMT. Gasoline blended with MMT reduces spark plug life and reduces emissions system performance in some vehicles. The manufacturer recommends that gasoline without MMT be used in your vehicle. The MMT

content of gasoline may not be indicated on the gasoline pump, therefore, you should ask your gasoline retailer whether the gasoline contains MMT. It is even more important to look for gasoline without MMT in Canada, because MMT can be used at levels higher than those allowed in the United States. MMT is prohibited in reformulated gasolines.

### **Materials Added to Fuel**

All gasoline sold in the United States is required to contain effective detergent additives. Use of additional detergents or other additives is not needed under normal conditions and they would result in additional cost. Therefore, you should not have to add anything to the fuel.

## STARTING AND OPERATING

### Fuel System Cautions

#### CAUTION!

Follow these guidelines to maintain your vehicle's performance:

- The use of leaded gas is prohibited by Federal law. Using leaded gasoline can impair engine performance and damage the emissions control system.

- An out-of-tune engine or certain fuel or ignition malfunctions can cause the catalytic converter to overheat. If you notice a pungent burning odor or some light smoke, your engine may be out of tune or malfunctioning and may require immediate service. Contact your authorized dealer for service assistance.
- The use of fuel additives, which are now being sold as octane enhancers, is not recommended. Most of these products contain high concentrations of methanol. Fuel system damage or vehicle performance problems resulting from the use of such fuels or additives is not the responsibility of the manufacturer.

**NOTE:** *Intentional tampering with the emissions control system can result in civil penalties being assessed against you.*

### Carbon Monoxide Warnings

#### WARNING!

Carbon monoxide (CO) in exhaust gases is deadly. Follow the precautions below to prevent carbon monoxide poisoning:

**STARTING AND OPERATING**

art=056502429.tif NO TRANS

- Do not inhale exhaust gases. They contain carbon monoxide, a colorless and odorless gas, which can kill. Never run the engine in a closed area, such as a garage, and never sit in a parked vehicle with the engine running for an extended period. If the vehicle is stopped in an open area with the engine running for more than a short period, adjust the ventilation system to force fresh, outside air into the vehicle.
- Guard against carbon monoxide with proper maintenance. Have the exhaust system inspected every time the vehicle is raised. Have any abnormal conditions repaired promptly. Until repaired, drive with all side windows fully open.

- Keep the liftgate closed when driving your vehicle to prevent carbon monoxide and other poisonous exhaust gases from entering the vehicle.

**FLEXIBLE FUEL (3.6L ENGINE ONLY) — IF EQUIPPED**

**E-85 General Information**

The information in this section is for Flexible Fuel vehicles only. These vehicles can be identified by a unique fuel filler door label that states **Ethanol (E-85) or Unleaded Gasoline Only**. This section only covers those subjects that are unique to these vehicles. Please refer to the other sections of this manual for information on features that are common between Flexible Fuel and gasoline-only powered vehicles.

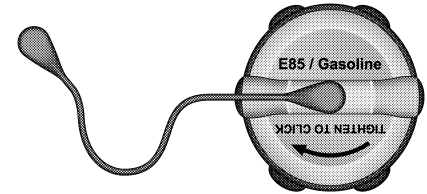

81ae46ab

E-85 Fuel Cap

**CAUTION!**

**Only vehicles with the E-85 fuel filler door label can operate on E-85.**

**STARTING AND OPERATING**

art=056502430.tif NO TRANS



81ae46a9

E-85 Badge

**Ethanol Fuel (E-85)**

E-85 is a mixture of approximately 85% fuel ethanol and 15% unleaded gasoline.

**WARNING!**

Ethanol vapors are extremely flammable and could cause serious personal injury. Never have any smoking materials lit in or near the vehicle when removing the fuel filler tube cap (gas cap) or filling the tank. Do not use E-85 as a cleaning agent and never use it near an open flame.

**Fuel Requirements**

Your vehicle will operate on both unleaded gasoline with an octane rating of 87, or E-85 fuel, or any mixture of these two. For best results, a refueling pattern that alternates between E-85 and unleaded gasoline should be avoided.

When you do switch fuel types it is recommended that:

- you do not switch when the fuel gauge indicates less than 1/4 full
- you do not add less than 5 gallons (19 Liters) when refueling
- you operate the vehicle immediately after refueling for a period of at least 5 minutes

Observing these precautions will avoid possible hard starting and/or significant deterioration in driveability during warm up.

**NOTE:**

- *When the ambient temperature is above 90° F (32° C), you may experience hard starting and rough idle following start up even if the above recommendations are followed.*

**STARTING AND OPERATING**

- *Some additives used in regular gasoline are not fully compatible with E-85 and may form deposits in your engine. To eliminate driveability issues that may be caused by these deposits, a supplemental gasoline additive, such as MOPAR® Injector Cleanup or Techron may be used.*

**Selection Of Engine Oil For Flexible Fuel Vehicles (E-85) and Gasoline Vehicles**

FFV vehicles operated on E-85 require specially formulated engine oils. These special requirements are included in MOPAR® engine oils, and in equivalent oils meeting Chrysler Specification MS-6395. The manufacturer requires engine oils that are API Certified and meet the requirements of Material Standard MS-6395. MS-6395 contains additional re-

quirements, developed during extensive fleet testing, to provide additional protection to Chrysler Group LLC engines. Use MOPAR® or an equivalent oil meeting the specification MS-6395.

**Starting**

The characteristics of E-85 fuel make it unsuitable for use when ambient temperatures fall below 0°F (-18°C). In the range of 0°F (-18°C) to 32°F (0°C), you may experience an increase in the time it takes for your engine to start, and a deterioration in driveability (sags and/or hesitations) until the engine is fully warmed up.

**NOTE:** *Use of the engine block heater (if equipped) is beneficial for E-85 startability when the ambient temperature is less than 32°F (0°C).*

**Cruising Range**

Because E-85 fuel contains less energy per gallon/liter than gasoline, you will experience an increase in fuel consumption. You can expect your miles per gallon (mpg)/miles per liter and your driving range to decrease by about 30%, compared to gasoline operation.

**Replacement Parts**

Many components in your Flexible Fuel Vehicle (FFV) are designed to be compatible with ethanol. Always be sure that your vehicle is serviced with correct ethanol compatible parts.

<b>CAUTION!</b>
<b>Replacing fuel system components with non-ethanol compatible components can damage your vehicle.</b>

## STARTING AND OPERATING

### Maintenance

#### CAUTION!

Do not use ethanol mixture greater than 85% in your vehicle. It will cause difficulty in cold starting and may affect driveability.

## ADDING FUEL

### Fuel Filler Cap (Gas Cap)

The gas cap is located behind the fuel filler door on the left side of the vehicle. If the gas cap is lost or damaged, be sure the replacement cap has been designed for use with this vehicle.

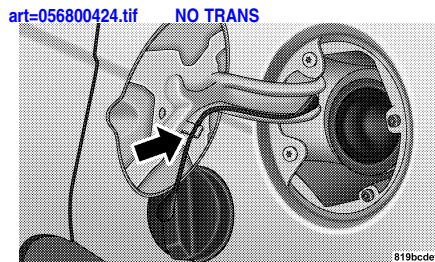

Fuel Filler Cap (Gas Cap)

**NOTE:** When removing the fuel filler cap, lay the cap tether in the hook, located on the fuel filler door reinforcement.

#### CAUTION!

- Damage to the fuel system or emissions control system could result from using an improper fuel tank filler tube cap (gas cap).

- A poorly fitting gas cap could let impurities into the fuel system.
- A poorly fitting gas cap may cause the “Malfunction Indicator Light (MIL)” to turn on.
- To avoid fuel spillage and overfilling, do not “top off” the fuel tank after filling. When the fuel nozzle “clicks” or shuts off, the fuel tank is full.

#### WARNING!

- Never have any smoking materials lit in or near the vehicle when the gas cap is removed or the tank is being filled.



## STARTING AND OPERATING

- **Never add fuel to the vehicle when the engine is running. This may violate certain regulations and/or local bylaws, and may cause the MIL to turn on.**
- **A fire may result if gasoline is pumped into a portable container that is inside of a vehicle. You could be burned. Always place gas containers on the ground while filling.**
- **Failure to follow this warning may result in serious injury or death.**

### NOTE:

- *Tighten the gas cap until you hear a “clicking” sound. This is an indication that the gas cap is tightened properly. The MIL in the instrument cluster may turn on if the gas cap is not secured*

*properly. Make sure that the gas cap is tightened each time the vehicle is refueled.*

- *When the fuel nozzle “clicks” or shuts off, the fuel tank is full.*

### Loose Fuel Filler Cap Message

If the vehicle diagnostic system determines that the fuel filler cap is loose, improperly installed, or damaged, the word “gASCAP” will display in the odometer. If this occurs, tighten the fuel filler cap until a “clicking” sound is heard and press the TRIP ODOMETER button to turn off the message. If the problem persists, the message will appear the next time the vehicle is started.

A loose, improperly installed, or damaged fuel filler cap may also turn on the MIL.

Refer to “Onboard Diagnostic System” in “Maintaining Your Vehicle” for further information.

### VEHICLE LOADING

The load carrying capacity of your vehicle is shown on the “Vehicle Certification Label.” This information should be used for passenger and luggage loading as indicated.

Do not exceed the specified Gross Vehicle Weight Rating (GVWR) or the Gross Axle Weight Rating (GAWR).

### Vehicle Certification Label

Your vehicle has a Vehicle Certification Label affixed to the rear of the driver’s door.

The label contains the following information:

## STARTING AND OPERATING

- Name of manufacturer
- Month and year of manufacture
- Gross Vehicle Weight Rating (GVWR)
- Gross Axle Weight Rating (GAWR) front
- Gross Axle Weight Rating (GAWR) rear
- Vehicle Identification Number (VIN)
- Type of Vehicle
- Month Day and Hour of Manufacture (MDH)

The bar code allows a computer scanner to read the VIN.

### **Gross Vehicle Weight Rating (GVWR)**

The GVWR is the total allowable weight of your vehicle. This includes driver, passen-

gers, and cargo. The total load must be limited so that you do not exceed the GVWR.

### **Gross Axle Weight Rating (GAWR)**

The GAWR is the maximum capacity of the front and rear axles. Distribute the load over the front and rear axles evenly. Make sure that you do not exceed either front or rear GAWR.

### **WARNING!**

**Because the front wheels steer the vehicle, it is important that you do not exceed the maximum front or rear GAWR. A dangerous driving condition can result if either rating is exceeded. You could lose control of the vehicle and have a collision.**

### **Overloading**

The load carrying components (axle, springs, tires, wheels, etc.) of your vehicle will provide satisfactory service as long as you do not exceed the GVWR and the front and rear GAWR.

The best way to figure out the total weight of your vehicle is to weigh it when it is fully loaded and ready for operation. Weigh it on a commercial scale to ensure that it is not over the GVWR.

Figure out the weight on the front and rear of the vehicle separately. It is important that you distribute the load evenly over the front and rear axles.

Overloading can cause potential safety hazards and shorten useful service life.

---

## STARTING AND OPERATING

Heavier axles or suspension components do not necessarily increase the vehicle's GVWR.

### **Loading**

To load your vehicle properly, first figure out its empty weight, axle-by-axle and side-by-side. Store heavier items down low and be sure you distribute their weight as evenly as possible. Stow all loose items securely before driving. If weighing the loaded vehicle shows that you have exceeded either GAWR, but the total load is within the specified GVWR, you must redistribute the weight. Improper weight distribution can have an adverse effect on the way your vehicle steers and handles and the way the brakes operate.

### **TRAILER TOWING**

In this section, you will find safety tips and information on limits to the type of towing you can reasonably do with your vehicle. Before towing a trailer, carefully review this information to tow your load as efficiently and safely as possible.

To maintain warranty coverage, follow the requirements and recommendations in this manual concerning vehicles used for trailer towing.

### **Common Towing Definitions**

The following trailer towing related definitions will assist you in understanding the following information:

#### **Gross Vehicle Weight Rating (GVWR)**

The GVWR is the total allowable weight of your vehicle. This includes driver, passengers, cargo, and tongue weight. The total

load must be limited so that you do not exceed the GVWR. Refer to "Vehicle Loading/Vehicle Certification Label" in "Starting and Operating" for further information.

#### **Gross Trailer Weight (GTW)**

The GTW is the weight of the trailer plus the weight of all cargo, consumables, and equipment (permanent or temporary) loaded in or on the trailer in its "loaded and ready for operation" condition.

The recommended way to measure GTW is to put your fully loaded trailer on a vehicle scale. The entire weight of the trailer must be supported by the scale.

## STARTING AND OPERATING

### Gross Combination Weight Rating (GCWR)

The GCWR is the total permissible weight of your vehicle and trailer when weighed in combination.

**NOTE:** *The GCWR rating includes a 150 lbs (68 kg) allowance for the presence of a driver.*

### Gross Axle Weight Rating (GAWR)

The GAWR is the maximum capacity of the front and rear axles. Distribute the load over the front and rear axles evenly. Make sure that you do not exceed either front or rear GAWR. Refer to "Vehicle Loading/ Vehicle Certification Label" in "Starting and Operating" for further information.

### WARNING!

**It is important that you do not exceed the maximum front or rear GAWR. A dangerous driving condition can result if either rating is exceeded. You could lose control of the vehicle and have a collision.**

### Tongue Weight (TW)

The tongue weight is the downward force exerted on the hitch ball by the trailer. In most cases, it should not be less than 10% or more than 15% of the trailer load. You must consider this as part of the load on your vehicle.

### Frontal Area

The frontal area is the maximum height multiplied by the maximum width of the front of a trailer.

### Trailer Sway Control – Electronic

Refer to "Electronic Brake Control System/ Trailer Sway Control (TSC)" in "Starting and Operating" for further information.

### Trailer Sway Control – Mechanical

The trailer sway control is a telescoping link that can be installed between the hitch receiver and the trailer tongue that typically provides adjustable friction associated with the telescoping motion to dampen any unwanted trailer swaying motions while traveling.

### Weight-Carrying Hitch

A weight-carrying hitch supports the trailer tongue weight, just as if it were luggage located at a hitch ball or some other connecting point of the vehicle. These kinds of hitches are the most popular on the market today and they are

**STARTING AND OPERATING**

commonly used to tow small- and medium-sized trailers.

**Weight-Distributing Hitch**

A weight-distributing system works by applying leverage through spring (load) bars. They are typically used for heavier loads to distribute trailer tongue weight to the tow vehicle's front axle and the trailer axle(s). When used in accordance with the manufacturers directions, it provides for a more level ride, offering more consistent steering and brake control thereby enhancing towing safety. The addition of a friction / hydraulic sway control also dampens sway caused by traffic and crosswinds and contributes positively to tow vehicle and trailer stability. Trailer sway control and a weight distributing (load equalizing) hitch are recommended for heavier Tongue Weights (TW) and may

be required depending on vehicle and trailer configuration/loading to comply with Gross Axle Weight Rating (GAWR) requirements.

**WARNING!**

- **An improperly adjusted weight distributing hitch system may reduce handling, stability, braking performance, and could result in a collision.**
- **Weight distributing systems may not be compatible with surge brake couplers. Consult with your hitch and trailer manufacturer or a reputable recreational vehicle dealer for additional information.**

art=057007215.tif NO TRANS

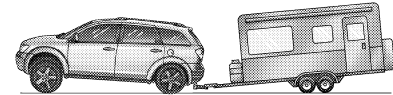

057007215

Without Weight-Distributing Hitch (Incorrect)  
art=057007214.tif NO TRANS

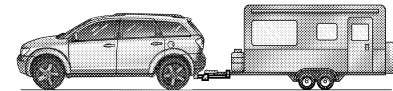

057007214

With Weight-Distributing Hitch (Correct)

**STARTING AND OPERATING**

art=057007212.tif NO TRANS

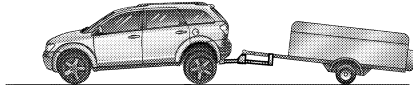

057007212

**Improper Adjustment of Weight-Distributing Hitch (Incorrect)**

**Trailer Hitch Classification**

Your vehicle may be factory equipped for safe towing of trailers weighing over 2,000 lbs (907 kg) with the optional Trailer Tow Prep Package. See your authorized dealer for package content.

The following chart provides the industry standard for the maximum trailer weight a given trailer hitch class can tow and should be used to assist you in selecting the correct trailer hitch for your intended towing condition.

<b>Trailer Hitch Classification Definitions</b>	
<b>Class</b>	<b>Max. Trailer Hitch Industry Standards</b>
Class I - Light Duty	2,000 lbs (907 kg)
Class II - Medium Duty	3,500 lbs (1 587 kg)
Class III - Heavy Duty	5,000 lbs (2 268 kg)

<b>Trailer Hitch Classification Definitions</b>	
Class IV - Extra Heavy Duty	10,000 lbs (4 540 kg)
Refer to the "Trailer Towing Weights (Maximum Trailer Weight Ratings)" chart for the Maximum Gross Trailer Weight (GTW) towable for your given drivetrain.	

All trailer hitches should be professionally installed on your vehicle.

**STARTING AND OPERATING**

**Trailer Towing Weights (Maximum Trailer Weight Ratings)**

The following chart provides the maximum trailer weight ratings towable for your given drivetrain.

Engine/Transmission	GCWR (Gross Combined Wt. Rating)	Frontal Area	Max. GTW (Gross Trailer Wt.)	Max. Tongue Wt.
<b>2.4L/Automatic</b>	6,000 lbs (2 722 kg)	22 sq ft (2.0 sq m)	1,000 lbs (454 kg) which includes up to 5 persons & Luggage	100 lbs (45 kg)
<b>3.6L/Automatic (without Trailer Tow Prep Package)</b>	7,300 lbs (3 311 kg)	32 sq ft (3.0 sq m)	2,000 lbs (907 kg) which includes 1 to 2 persons & Luggage	200 lbs (91 kg)
	7,300 lbs (3 311 kg)	32 sq ft (3.0 sq m)	1,500 lbs (680 kg) which includes 3 to 4 persons & Luggage	150 lbs (68 kg)
	7,300 lbs (3 311 kg)	32 sq ft (3.0 sq m)	1,000 lbs (454 kg) which includes 5 to 7 persons & Luggage	100 lbs (45 kg) *Except for AWD models.

**STARTING AND OPERATING**

Engine/Transmission	GCWR (Gross Combined Wt. Rating)	Frontal Area	Max. GTW (Gross Trailer Wt.)	Max. Tongue Wt.
<b>3.6L/Automatic (with Trailer Tow Prep Package)</b>	8,300 lbs (3 765 kg)	40 sq ft (3.7 sq m)	3,500 lbs (1 588 kg) which includes 1 to 2 persons & Luggage	350 lbs (159 kg)
	8,300 lbs (3 765 kg)	40 sq ft (3.7 sq m)	3,000 lbs (1 361 kg) which includes 3 to 4 persons & Luggage	300 lbs (136 kg)
	8,300 lbs (3 765 kg)	40 sq ft (3.7 sq m)	2,500 lbs (1 134 kg) which includes 5 to 6 persons & Luggage	250 lbs (113 kg) *Except for AWD models.
	8,300 lbs (3 765 kg)	40 sq ft (3.7 sq m)	2,500 lbs (1 134 kg) which includes 7 persons & Luggage	100 lbs (113 kg) *Except for AWD models.



**STARTING AND OPERATING**

Engine/Transmission	GCWR (Gross Combined Wt. Rating)	Frontal Area	Max. GTW (Gross Trailer Wt.)	Max. Tongue Wt.
<p><b>NOTE:</b></p> <ul style="list-style-type: none"> <li>The trailer tongue weight must be considered as part of the combined weight of occupants and cargo, and should never exceed the weight referenced on the Tire and Loading Information placard. Refer to "Tire Safety Information" in "Starting and Operating" for further information.</li> <li>* For All Wheel Drive (AWD) models carrying 5 to 7 persons and luggage will exceed the rear Gross Axle Weight Rating (GAWR) and therefore should not be attempted.</li> </ul>				

**Trailer And Tongue Weight**

Always load a trailer with 60% to 65% of the weight in the front of the trailer. This places 10% to 15% of the Gross Trailer Weight (GTW) on the tow hitch of your vehicle. Loads balanced over the wheels or heavier in the rear can cause the trailer to sway **severely** side to side which will cause loss of control of the vehicle and trailer. Failure to load trailers heavier in front is the cause of many trailer collisions.

Never exceed the maximum tongue weight stamped on your bumper or trailer hitch.

art=057003767.tif NO TRANS

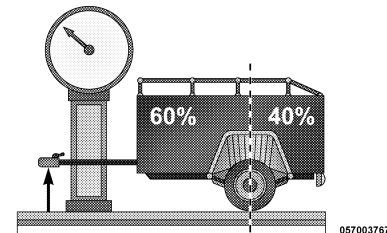

## STARTING AND OPERATING

Consider the following items when computing the weight on the rear axle of the vehicle:

- The tongue weight of the trailer.
- The weight of any other type of cargo or equipment put in or on your vehicle.
- The weight of the driver and all passengers.

**NOTE:** Remember that everything put into or on the trailer adds to the load on your vehicle. Also, additional factory-installed options or authorized dealer-installed options must be considered as part of the total load on your vehicle. Refer to the "Tire and Loading Information" placard for the maximum combined weight of occupants and cargo for your vehicle.

### Towing Requirements

To promote proper break-in of your new vehicle drivetrain components the following guidelines are recommended:

#### CAUTION!

- Do not tow a trailer at all during the first 500 miles (805 km) the new vehicle is driven. The engine, axle or other parts could be damaged.
- Then, during the first 500 miles (805 km) that a trailer is towed, do not drive over 50 mph (80 km/h) and do not make starts at full throttle. This helps the engine and other parts of the vehicle wear in at the heavier loads.

Perform the maintenance listed in the "Maintenance Schedule." Refer to "Main-

tenance Schedule" for further information. When towing a trailer, never exceed the GAWR, or GCWR, ratings.

#### WARNING!

**Improper towing can lead to a collision. Follow these guidelines to make your trailer towing as safe as possible:**

- Make certain that the load is secured in the trailer and that it will not shift during travel. When trailering cargo that is not fully secured, dynamic load shifts can occur that may be difficult for the driver to control. You could lose control of your vehicle and have a collision.

---

## STARTING AND OPERATING

- When hauling cargo or towing a trailer, do not overload your vehicle or trailer. Overloading can cause a loss of control, poor performance, or damage to brakes, axle, engine, transmission, steering, suspension, chassis structure, or tires.
- Safety chains must always be used between your vehicle and trailer. Always connect the chains to the frame or hook retainers of the vehicle hitch. Cross the chains under the trailer tongue and allow enough slack for turning corners.

- Vehicles with trailers should not be parked on a grade. When parking, apply the parking brake on the tow vehicle. Put the tow vehicle automatic transmission in PARK. Always, block or "chock" the trailer wheels.
- GCWR must not be exceeded.
- Total weight must be distributed between the tow vehicle and the trailer such that the following four ratings are not exceeded:
  1. GVWR
  2. GTW
  3. GAWR

4. Tongue weight rating for the trailer hitch utilized. (This requirement may limit the ability to always achieve the 10% to 15% range of tongue weight as a percentage of total trailer weight.)

### Towing Requirements – Tires

- Do not attempt to tow a trailer while using a compact spare tire.
- Proper tire inflation pressures are essential to the safe and satisfactory operation of your vehicle. Refer to "Tires – General Information" in "Starting and Operating" for proper tire inflation procedures.
- Check the trailer tires for proper tire inflation pressures before trailer usage.

## STARTING AND OPERATING

- Check for signs of tire wear or visible tire damage before towing a trailer. Refer to "Tires – General Information" in "Starting and Operating" for the proper inspection procedure.
- When replacing tires, refer to "Tires – General Information" in "Starting and Operating" for information on replacement tires and for the proper tire replacement procedures. Replacing tires with a higher load carrying capacity will not increase the vehicle's GVWR and GAWR limits.
- An electronically actuated trailer brake controller is required when towing a trailer with electronically actuated brakes. When towing a trailer equipped with a hydraulic surge actuated brake system, an electronic brake controller is not required.
- Trailer brakes are recommended for trailers over 1,000 lbs (454 kg) and required for trailers in excess of 2,000 lbs (907 kg).

### Towing Requirements – Trailer Brakes

- Do **not** interconnect the hydraulic brake system or vacuum system of your vehicle with that of the trailer. This could cause inadequate braking and possible personal injury.

#### CAUTION!

**If the trailer weighs more than 1,000 lbs (454 kg) loaded, it should have its own brakes, and they should be of adequate capacity. Failure to do this could lead to accelerated brake lining wear, higher brake pedal effort, and longer stopping distances.**

#### WARNING!

- **Do not connect trailer brakes to your vehicle's hydraulic brake lines. It can overload your brake system and cause it to fail. You might not have brakes when you need them and could have a collision.**

**STARTING AND OPERATING**

- **Towing any trailer will increase your stopping distance. When towing, you should allow for additional space between your vehicle and the vehicle in front of you. Failure to do so could result in a collision.**

**Towing Requirements – Trailer Lights and Wiring**

Whenever you pull a trailer, regardless of the trailer size, stoplights and turn signals on the trailer are required for motoring safety.

The Trailer Tow Package may include a four- and seven-pin wiring harness. Use a factory approved trailer harness and connector.

**NOTE:** Do not cut or splice wiring into the vehicles wiring harness.

The electrical connections are all complete to the vehicle but you must mate the harness to a trailer connector. Refer to the following illustrations.

art=057003766.tif

**NO TRANS**

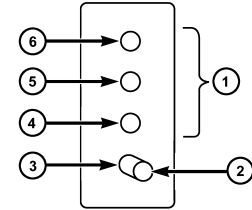

057003766

**Four-Pin Connector**

- |                 |                         |
|-----------------|-------------------------|
| 1 — Female Pins | 4 — Park                |
| 2 — Male Pin    | 5 — Left Stop/Turn      |
| 3 — Ground      | 6 — Right Stop/<br>Turn |

**STARTING AND OPERATING**

art=057003765.tif NO TRANS

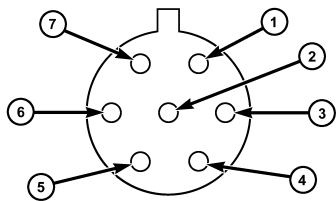

057003765

**Seven-Pin Connector**

- |                     |                    |
|---------------------|--------------------|
| 1 — Battery         | 5 — Ground         |
| 2 — Backup Lamps    | 6 — Left Stop/Turn |
| 3 — Right Stop/Turn | 7 — Running Lamps  |
| 4 — Electric Brakes |                    |

**Towing Tips**

Before setting out on a trip, practice turning, stopping, and backing up the trailer in an area located away from heavy traffic.

**Automatic Transmission**

The DRIVE range can be selected when towing. However, if frequent shifting occurs while in this range, use the Autostick® feature to select a lower gear.

**NOTE:** Using a lower gear range while operating the vehicle under heavy operating conditions will improve performance and extend transmission life by reducing excessive shifting and heat build up. This action will also provide better engine braking.

If you REGULARLY tow a trailer for more than 45 minutes of continuous operation, then change the transmission fluid and

automatic transmission filter according to the interval specified for "police, taxi, fleet, or frequent trailer towing." Refer to the "Maintenance Schedule" for the proper maintenance intervals.

**NOTE:** Check the automatic transmission fluid level before towing. The six-speed transmission is sealed and the fluid level cannot be checked. See your authorized dealer for assistance.

**Electronic Speed Control – If Equipped**

- Do not use in hilly terrain or with heavy loads.
- When using the speed control, if you experience speed drops greater than 10 mph (16 km/h), disengage until you can get back to cruising speed.

**STARTING AND OPERATING**

- Use speed control in flat terrain and with light loads to maximize fuel efficiency.

**AutoStick® – If Equipped**

- By using the AutoStick® modes and selecting a specific gear range, frequent shifting can be avoided. The highest gear range should be selected that allows for adequate performance. For example, choose “4” if the desired speed can be maintained. Choose “3” or “2” if needed to maintain the desired speed.
- Extended driving at high RPM should be avoided to prevent excess heat generation. A reduction in vehicle speed may be required to avoid extended driving at high RPM. Return to a higher

gear range or vehicle speed when road conditions and RPM level allows.

**Cooling System**

To reduce potential for engine and transmission overheating, take the following actions:

**– City Driving**

When stopped for short periods, shift the transmission into NEUTRAL and increase engine idle speed.

**– Highway Driving**

Reduce speed.

**– Air Conditioning**

Turn off temporarily.

**RECREATIONAL TOWING  
(BEHIND MOTORHOME, ETC.)**

**Recreational towing is not allowed. DO NOT flat tow this vehicle. Damage to the drivetrain will result.**

**NOTE:** *This vehicle may be towed on a flatbed or vehicle trailer provided all four wheels are **OFF** the ground.*

**CAUTION!**

**Towing this vehicle in violation of the above requirements can cause severe transmission and/or transfer case damage. Damage from improper towing is not covered under the New Vehicle Limited Warranty.**





# SECTION 6

## WHAT TO DO IN EMERGENCIES

• HAZARD WARNING FLASHERS .....	326	• Preparations For Jump-Start .....	335
• IF YOUR ENGINE OVERHEATS .....	326	• Jump-Starting Procedure .....	336
• 2.4L Engine — If Equipped .....	327	• FREEING A STUCK VEHICLE .....	338
• JACKING AND TIRE CHANGING .....	327	• SHIFT LEVER OVERRIDE .....	339
• Jack Location .....	328	• With Keyless Enter-N-Go — If Equipped .....	339
• Spare Tire Location .....	328	• TOWING A DISABLED VEHICLE .....	340
• Preparations For Jacking .....	328	• All-Wheel Drive (AWD) .....	341
• Spare Tire Removal .....	329	• Front-Wheel Drive (FWD) .....	341
• Spare Tire Stowage .....	330	• Without The Ignition Key .....	342
• Jacking Instructions .....	331	• All-Wheel Drive (AWD) .....	342
• JUMP-STARTING .....	335		

## WHAT TO DO IN EMERGENCIES

### HAZARD WARNING FLASHERS

The Hazard Warning flasher switch is located in the instrument panel switch bank, above the climate controls.

art=060102358.tif **NO TRANS**



Press the switch to turn on the Hazard Warning flasher. When the switch is activated, all directional turn signals will flash on and off to warn oncoming traffic of an emergency. Press the switch a second time to turn off the Hazard Warning flashers.

This is an emergency warning system and it should not be used when the vehicle is in motion. Use it when your vehicle is disabled and it is creating a safety hazard for other motorists.

When you must leave the vehicle to seek assistance, the Hazard Warning flashers

will continue to operate even though the ignition is placed in the OFF position.

**NOTE:** *With extended use the Hazard Warning flashers may wear down your battery.*

### IF YOUR ENGINE OVERHEATS

In any of the following situations, you can reduce the potential for overheating by taking the appropriate action.

- On the highways — slow down.
- In city traffic — while stopped, place the transmission in NEUTRAL, but do not increase engine idle speed.

**NOTE:** *There are steps that you can take to slow down an impending overhear condition:*

- *If your air conditioner (A/C) is on, turn it off. The A/C system adds heat to the engine cooling system and turning the A/C off can help remove this heat.*
- *You can also turn the temperature control to maximum heat, the mode control to floor and the blower control to High. This allows the heater core to act as a supplement to the radiator and aids in removing heat from the engine cooling system.*

## WHAT TO DO IN EMERGENCIES

### CAUTION!

Driving with a hot cooling system could damage your vehicle. If the temperature gauge reads “H,” safely pull over and stop the vehicle. Idle the vehicle with the A/C turned off until the pointer drops back into the normal range. If the pointer remains on the “H,” and you hear continuous chimes, turn the engine OFF immediately, and call for service.

### WARNING!

You or others can be badly burned by hot engine coolant (antifreeze) or steam from your radiator. If you see or hear steam coming from under the hood, do not open the hood until the radiator has had time to cool. Never try to open a cooling system pressure cap when the radiator or coolant bottle is hot.

#### 2.4L Engine — If Equipped

On hot days the engine oil temperature may become too hot during sustained high-speed driving or if towing a trailer up long grades. If this happens, a HOTOIL message will flash in the odometer and the vehicle speed will be reduced to 48 mph (77 km/h) maximum until the engine oil temperature is reduced.

**NOTE:** *The maximum vehicle speed is reduced to 48 mph (77 km/h), you may reduce vehicle speed further as needed. Once the engine oil temperature is reduced, you may continue to drive normally.*

### JACKING AND TIRE CHANGING

#### WARNING!

- **Do not attempt to change a tire on the side of the vehicle close to moving traffic. Pull far enough off the road to avoid the danger of being hit when operating the jack or changing the wheel.**

## WHAT TO DO IN EMERGENCIES

- **Being under a jacked-up vehicle is dangerous. The vehicle could slip off the jack and fall on you. You could be crushed. Never put any part of your body under a vehicle that is on a jack.**
- **Never start or run the engine while the vehicle is on a jack. If you need to get under a raised vehicle, take it to a service center where it can be raised on a lift.**
- **The jack is designed to be used as a tool for changing tires only. The jack should not be used to lift the vehicle for service purposes. The vehicle should be jacked on a firm level surface only. Avoid ice or slippery areas.**

### Jack Location

The jack and jack-handle are stowed underneath a cover in the rear storage bin in the cargo area.

art=060536915.tif NO TRANS

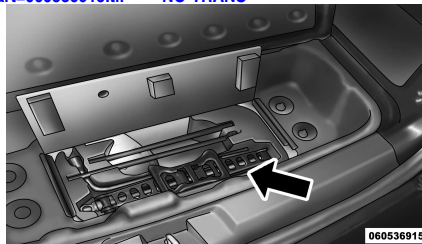

Jack Storage Location

### Spare Tire Location

The spare tire is stowed underneath the rear of the vehicle and is held in place by means of a cable winch mechanism.

### Preparations For Jacking

1. Park the vehicle on a firm, level surface as far from the edge of the roadway as possible. Avoid icy or slippery areas.

#### WARNING!

**Do not attempt to change a tire on the side of the vehicle close to moving traffic. Pull far enough off the road to avoid the danger of being hit when operating the jack or changing the wheel.**

2. Turn on the Hazard Warning flashers.
3. Set the parking brake.
4. Place the shift lever in PARK.
5. Turn OFF the ignition.

**WHAT TO DO IN EMERGENCIES**

art=060505162.tif **NO TRANS**



060505162

6. Block both the front and rear of the wheel diagonally opposite of the jacking position. For example, if changing the right front tire, block the left rear

wheel.

**NOTE:** *Passengers should not remain in the vehicle when the vehicle is being jacked.*

**Spare Tire Removal**

**NOTE:** *On seven-passenger models, fold the third-row passenger seats flat. This will provide more space when accessing the jacking tools and when operating the winch mechanism.*

1. Remove the jack-handle components 1, 2 and 3 from storage and assemble them.

art=060536916.tif **NO TRANS**

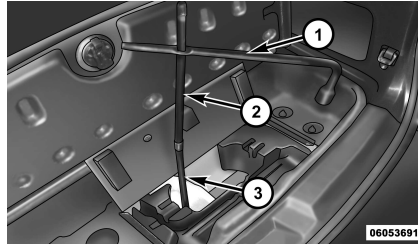

**Lowering/Raising Spare Tire**

**NOTE:** *Assemble components 2 and 3 by seating the small ball at the end of component 2 in the small hole at the end of component 3. This will lock these components together. Assemble components 1 and 2 so that the wheel nut socket at the*

*end of component 1 faces upward when seated on component 2. This will make it easier to rotate the assembly when operating the winch mechanism.*

2. Fit the assembled jack-handle over the winch drive nut located in the jack storage area. Rotate the jack-handle assembly counterclockwise until the spare tire is on the ground with enough cable slack to allow you to pull the spare tire out from underneath the vehicle.

**CAUTION!**

**The winch mechanism is designed for use with the jack-handle only. Use of an air wrench or other power tools is not recommended and it can damage the winch.**

## WHAT TO DO IN EMERGENCIES

3. Pull the spare tire out from underneath the vehicle and raise it upright so the tire's tread is on the ground.

4. Tilt the retainer at the end of the winch cable and remove it from the center of the wheel.

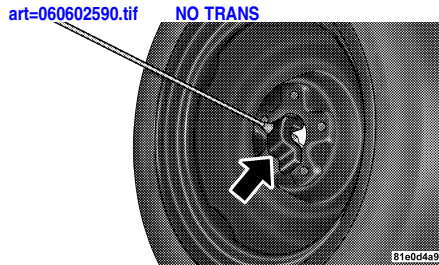

Spare Tire Retainer

### Spare Tire Stowage

**NOTE:** On seven-passenger models, fold the third-row passenger seats flat. This will provide more space when accessing the jacking tools and when operating the winch mechanism.

1. Remove the jack-handle components 1, 2, and 3 from storage and assemble them.

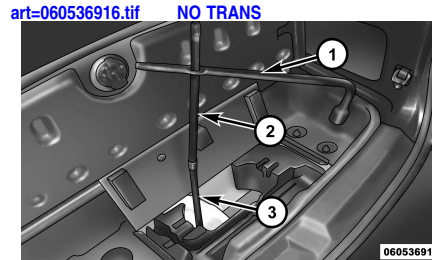

Lowering/Raising Spare Tire

**NOTE:** Assemble components 2 and 3 by seating the small ball at the end of component 2 in the small hole at the end of component 3. This will lock these components together. Assemble components 1 and 2 so that the wheel nut socket at the end of component 1 faces upward when seated on component 2. This will make it easier to rotate the assembly when operating the winch mechanism.

2. Fit the assembled jack-handle over the winch drive nut located in the jack storage area. Rotate the jack-handle assembly counterclockwise until there is enough cable slack to allow you to pull the cable and retainer out from underneath the vehicle.

WHAT TO DO IN EMERGENCIES

**CAUTION!**

The winch mechanism is designed for use with the jack-handle only. Use of an air wrench or other power tools is not recommended and it can damage the winch.

3. Place the spare tire near to the winch cable. Hold the spare upright so that the tire's tread is on the ground and the valve stem is at the top of the wheel facing away from the rear of the vehicle.

4. Tilt the retainer at the end of the winch cable and drop it through the center of the wheel. Then place the spare tire with the cable and retainer underneath the vehicle.

art=060602590.tif

NO TRANS

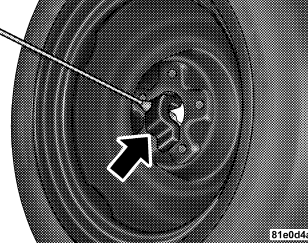

Spare Tire Retainer

5. Fit the assembled jack-handle over the winch drive nut. Rotate the jack-handle assembly clockwise to raise the spare tire into the storage area. Continue to rotate the jack-handle assembly until you hear the winch mechanism click three times. It cannot be over tightened. Push against the tire several times to be sure it is held securely in place.

Jacking Instructions

**WARNING!**

Carefully follow these tire changing warnings to help prevent personal injury or damage to your vehicle:

- Always park on a firm, level surface as far from the edge of the roadway as possible before raising the vehicle.
- Turn on the Hazard Warning flasher.
- Block the wheel diagonally opposite the wheel to be raised.
- Set the parking brake firmly and set an automatic transmission in **PARK**.

## WHAT TO DO IN EMERGENCIES

- Never start or run the engine with the vehicle on a jack.
- Do not let anyone sit in the vehicle when it is on a jack.
- Do not get under the vehicle when it is on a jack.
- Only use the jack in the positions indicated and for lifting this vehicle during a tire change.
- If working on or near a roadway, be extremely careful of motor traffic.
- To assure that spare tires, flat or inflated, are securely stowed, spares must be stowed with the valve stem facing the ground.

art=060600714.tif

NO TRANS



Jack Warning Label

### CAUTION!

Do not attempt to raise the vehicle by jacking on locations other than those indicated in the Jacking Instructions for this vehicle.

1. Remove the spare tire, jack, and jack-handle from stowage.
2. Loosen, but do not remove, the wheel nuts on the wheel with the flat tire. Turn the wheel nuts counterclockwise one turn while the wheel is still on the ground.

3. Place the jack underneath the lift area that is closest to the flat tire. Turn the jack screw clockwise to firmly engage the jack saddle with the lift area of the sill flange.

art=060508793.tif

NO TRANS

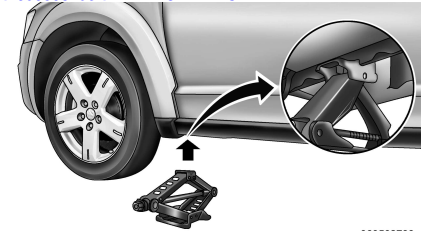

060508793

Front Jacking Location



**WHAT TO DO IN EMERGENCIES**

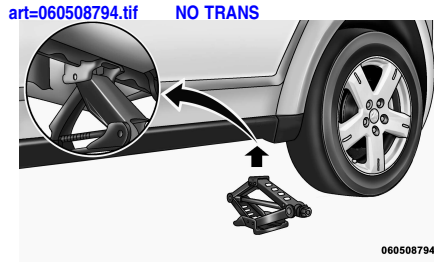

**Rear Jacking Location**

4. Raise the vehicle by turning the jack screw clockwise with the jack handle. Raise the vehicle until the tire just clears the road surface and enough clearance is obtained to install the spare tire. Minimum tire lift provides maximum stability.

**WARNING!**

**Raising the vehicle higher than necessary can make the vehicle less stable. It could slip off the jack and hurt someone near it. Raise the vehicle only enough to remove the tire.**

5. Remove the wheel nuts. For vehicles so equipped, remove the wheel cover from the wheel by hand. Do not pry the wheel cover off. Then pull the wheel off the hub.

**WARNING!**

**To avoid possible personal injury, handle the wheel covers with care to avoid contact with any sharp edges.**

**NOTE:** For vehicles so equipped, the wheel cover is held on the wheel by the

*wheel nuts. When reinstalling the original wheel, properly align the wheel cover to the valve stem, place the wheel cover onto the wheel, and then install the wheel nuts.*

6. Install the spare tire.

**NOTE:**

- For vehicles so equipped, do not attempt to install a center cap or wheel cover on the compact spare.
- Refer to "Compact Spare Tire" and to "Limited-Use Spare" under "Tires — General Information" in "Starting and Operating" for additional warnings, cautions, and information about the spare tire, its use, and operation.

7. Install the wheel nuts with the cone-shaped end of the nut toward the wheel. Lightly tighten the wheel nuts.

## WHAT TO DO IN EMERGENCIES

### WARNING!

**To avoid the risk of forcing the vehicle off the jack, do not tighten the wheel nuts fully until the vehicle has been lowered.**

8. Lower the vehicle by turning the jack screw counterclockwise with the jack handle.

9. Finish tightening the wheel nuts. Push down on the wrench while tightening for increased leverage. Alternate wheel nuts until each nut has been tightened twice. The correct wheel nut tightness is 95 ft lbs (130 N·m). If in doubt about the correct tightness, have them checked with a torque wrench by your authorized dealer or at a service station.

10. Lower the jack to its fully closed position.

### WARNING!

**A loose tire or jack, thrown forward in a collision or hard stop could endanger the occupants of the vehicle. Always stow the jack parts and the spare tire in the places provided. Have the deflated (flat) tire repaired or replaced immediately.**

11. Place the deflated (flat) tire in the cargo area. **Do not stow the deflated tire in the spare tire stowage location.** Have the deflated (flat) tire repaired or replaced as soon as possible.

12. To stow the winch cable and retainer, fit the assembled jack-handle over the

winch drive nut. Rotate the jack-handle assembly clockwise until you hear the winch mechanism click three times. It cannot be over tightened.

13. Stow the jack-handle and jack.

14. Check the tire pressure as soon as possible. Adjust the tire pressure as required.

### Wheel Nuts

Tighten all wheel nuts occasionally to eliminate the possibility of wheel studs being sheared or the bolt holes in the wheels becoming elongated. This is especially important during the first few hundred miles (kilometers) of operation and after changing a tire. This allows the wheel nuts to seat properly. All wheel nuts should first be firmly seated against the wheel. The wheel nuts should then be tightened

## WHAT TO DO IN EMERGENCIES

to the recommended torque. Tighten the wheel nuts to the final torque in increments. Progress around the bolt circle, tightening the nut opposite of the one you previously tightened until the final torque is achieved. Recommended torque is 95 ft lbs (130 N·m).

### JUMP-STARTING

If your vehicle has a discharged battery, it can be jump-started using a set of jumper cables and a battery in another vehicle or by using a portable battery booster pack. Jump-starting can be dangerous if done improperly so please follow the procedures in this section carefully.

**NOTE:** *When using a portable battery booster pack follow the manufacturer's operating instructions and precautions.*

#### CAUTION!

**Do not use a portable battery booster pack or any other booster source with a system voltage greater than 12 Volts or damage to the battery, starter motor, alternator or electrical system may occur.**

#### WARNING!

**Do not attempt jump-starting if the battery is frozen. It could rupture or explode and cause personal injury.**

#### Preparations For Jump-Start

The battery in your vehicle is located between the left front headlight assembly and the left front wheel splash shield. To allow jump-starting, there are remote bat-

tery posts located on the left side of the engine compartment.

art=060536917.tif NO TRANS

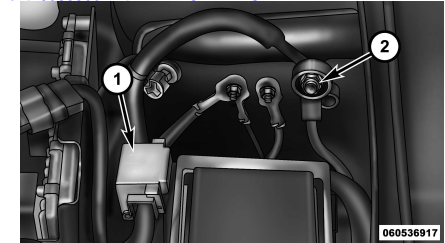

Remote Battery Posts

- 1 — Remote Positive (+) Post (Covered With Protective Cap)
- 2 — Remote Negative (-) Post

**WHAT TO DO IN EMERGENCIES**

**WARNING!**

- **Take care to avoid the radiator cooling fan whenever the hood is raised. It can start anytime the ignition switch is ON. You can be injured by moving fan blades.**
- **Remove any metal jewelry such as watch bands or bracelets that might make an inadvertent electrical contact. You could be seriously injured.**
- **Batteries contain sulfuric acid that can burn your skin or eyes and generate hydrogen gas which is flammable and explosive. Keep open flames or sparks away from the battery.**

1. Set the parking brake, shift the automatic transmission into PARK and turn the ignition to LOCK.
2. Turn off the heater, radio, and all unnecessary electrical accessories.
3. Remove the protective cover over the remote positive (+) battery post. To remove the cover, press the locking tab and pull upward on the cover.
4. If using another vehicle to jump-start the battery, park the vehicle within the jumper cables reach, set the parking brake and make sure the ignition is OFF.

**WARNING!**

**Do not allow vehicles to touch each other as this could establish a ground connection and personal injury could result.**

**Jump-Starting Procedure**

**WARNING!**

**Failure to follow this procedure could result in personal injury or property damage due to battery explosion.**

**WHAT TO DO IN EMERGENCIES**

**CAUTION!**

**Failure to follow these procedures could result in damage to the charging system of the booster vehicle or the discharged vehicle.**

1. Connect the positive (+) end of the jumper cable to the remote positive (+) post of the discharged vehicle.
2. Connect the opposite end of the positive (+) jumper cable to the positive (+) post of the booster battery.
3. Connect the negative end (-) of the jumper cable to the negative (-) post of the booster battery.
4. Connect the opposite end of the negative (-) jumper cable to the remote nega-

tive (-) post of the vehicle with the discharged battery.

**WARNING!**

**Do not connect the cable to the negative post (-) of the discharged battery. The resulting electrical spark could cause the battery to explode and could result in personal injury.**

5. Start the engine in the vehicle that has the booster battery, let the engine idle a few minutes, and then start the engine in the vehicle with the discharged battery.

Once the engine is started, remove the jumper cables in the reverse sequence:

6. Disconnect the negative (-) jumper cable from the remote negative (-) post of the vehicle with the discharged battery.

7. Disconnect the negative end (-) of the jumper cable from the negative (-) post of the booster battery.

8. Disconnect the opposite end of the positive (+) jumper cable from the positive (+) post of the booster battery.

9. Disconnect the positive (+) end of the jumper cable from the remote positive (+) post of the discharged vehicle.

10. Reinstall the protective cover over the remote positive (+) battery post of the discharged vehicle.

If frequent jump-starting is required to start your vehicle, you should have the battery and charging system inspected at your authorized dealer.

**WHAT TO DO IN EMERGENCIES**

**CAUTION!**

Accessories that can be plugged into the vehicle power outlets draw power from the vehicle's battery, even when not in use (i.e., cellular phones, etc.). Eventually, if plugged in long enough, the vehicle's battery will discharge sufficiently to degrade battery life and/or prevent the engine from starting.

**FREEING A STUCK VEHICLE**

If your vehicle becomes stuck in mud, sand, or snow, it can often be moved by a rocking motion. Turn your steering wheel right and left to clear the area around the front wheels. Then shift back and forth between DRIVE and REVERSE. Using the least accelerator pedal pressure to main-

tain the rocking motion without spinning the wheels is most effective.

**CAUTION!**

Racing the engine or spinning the wheels may lead to transmission overheating and failure. Allow the engine to idle with the shift lever in NEUTRAL for at least one minute after every five rocking-motion cycles. This will minimize overheating and reduce the risk of transmission failure during prolonged efforts to free a stuck vehicle.

art=040400566.tif NO TRANS



**NOTE:** If your vehicle is equipped with Traction Control, turn the system OFF before attempting to "rock" the vehicle. Refer to "Electronic

Stability Program (ESP)" in "Starting and Operating" for further information.

**CAUTION!**

- When "rocking" a stuck vehicle by moving between DRIVE and REVERSE, do not spin the wheels faster than 15 mph (24 km/h), or drivetrain damage may result.
- Revving the engine or spinning the wheels too fast may lead to transmission overheating and failure. It can also damage the tires. Do not spin the wheels above 30 mph (48 km/h) while in gear (no transmission shifting occurring).

## WHAT TO DO IN EMERGENCIES

### WARNING!

**Fast spinning tires can be dangerous. Forces generated by excessive wheel speeds may cause damage, or even failure, of the axle and tires. A tire could explode and injure someone. Do not spin your vehicle's wheels faster than 30 mph (48 km/h) or for longer than 30 seconds continuously without stopping when you are stuck and do not let anyone near a spinning wheel, no matter what the speed.**

### SHIFT LEVER OVERRIDE

If a malfunction occurs and the shift lever cannot be moved out of the PARK position, you can use the following procedure to temporarily move the shift lever:

1. Firmly apply the parking brake.
2. Open the center console and remove the shift lever override access cover.

art=061536186.tif NO TRANS



Shift Lever Override Access Cover

3. Turn the ignition switch to the ON/RUN position without starting the engine.
4. Press and maintain firm pressure on the brake pedal.

5. Insert a screwdriver or similar small tool into the hole at the front of the center console and push the manual override release lever.

6. Move the shift lever into the NEUTRAL position.

7. The vehicle may then be started in NEUTRAL.

8. Reinstall the shift lever override access cover in the center console.

### With Keyless Enter-N-Go — If Equipped

If the engine is running, press the START/STOP button to turn it off. Release the brake pedal and press the START/STOP button once or twice to go to the ON/RUN position. Do not start the engine. Then,

**WHAT TO DO IN EMERGENCIES**

follow the instructions shown above to activate the override.

**TOWING A DISABLED VEHICLE**

Towing Condition	Wheel OFF the Ground	FWD MODELS	AWD MODELS
Flat Tow	NONE	IF transmission is operable: <ul style="list-style-type: none"> <li>• Trans in <b>NEUTRAL</b></li> <li>• 25 mph (40 km/h) <b>max</b> speed</li> <li>• 15 miles (24 km) <b>max</b> distance</li> </ul>	<b>NO</b>
Wheel Lift Or Dolly Tow	Rear	<ul style="list-style-type: none"> <li>• 15 miles (24 km) <b>max</b> distance</li> </ul>	<b>NO</b>
	Front	OK	<b>NO</b>
Flatbed	<b>ALL</b>	<b>BEST METHOD</b>	OK

Proper towing or lifting equipment is required to prevent damage to your vehicle. Use only tow bars and other equipment designed for the purpose, following equipment manufacturer's instructions.

Use of safety chains is mandatory. Attach a tow bar or other towing device to main structural members of the vehicle, not to bumpers or associated brackets. State

and local laws applying to vehicles under tow must be observed.

If you must use the accessories (wipers, defrosters, etc.) while being towed, the



**WHAT TO DO IN EMERGENCIES**

ignition must be in the ON/RUN position, not the ACC position.

If the vehicle's battery is discharged, see "Shift Lever Override" in "What To Do In Emergencies" for further information.

**CAUTION!**

- **Do not attempt to use sling type equipment when towing. When securing the vehicle to a flat bed truck, do not attach to front or rear suspension components. Damage to your vehicle may result from improper towing.**
- **Do not push or tow this vehicle with another vehicle as damage to the bumper fascia and transmission may result.**

- **If the vehicle being towed requires steering, the ignition switch must be in the ON position, not the LOCK or ACC positions.**

**All-Wheel Drive (AWD)**

The manufacturer requires towing with all four wheels OFF the ground. Acceptable methods are to tow the vehicle on a flatbed, or with one end of vehicle raised and the opposite end on a towing dolly.

**CAUTION!**

**Failure to follow these towing methods could result in damage to the transmission and/or transfer case. Such damage is not covered by the New Vehicle Limited Warranty.**

**Front-Wheel Drive (FWD)**

The manufacturer recommends towing your vehicle with all four wheels OFF the ground using a flatbed.

If flatbed equipment is not available, and the transmission is operable, the vehicle may be flat towed (with all four wheels on the ground) under the following conditions:

- The shift lever must be in NEUTRAL.
- The distance to be traveled must not exceed 15 miles (24 km).
- The towing speed must not exceed 25 mph (40 km/h).

**If the transmission is not operable, or the vehicle must be towed faster than 25 mph (40 km/h) or farther than 15 miles (24 km), it must be towed with**

## WHAT TO DO IN EMERGENCIES

the front wheels OFF the ground (using a flatbed truck, towing dolly, or wheel lift equipment with the front wheels raised).

### CAUTION!

**Towing faster than 25 mph (40 km/h) or farther than 15 miles (24 km) with front wheels on the ground can cause severe damage to the transmission. Such damage is not covered by the New Vehicle Limited Warranty.**

### Without The Ignition Key

#### Front-Wheel Drive (FWD)

Special care must be taken when the vehicle is towed with the ignition in the LOCK position. Flatbed towing is the pre-

ferred towing method. However, if a flatbed towing vehicle is not available, wheel lift towing equipment may be used. Rear towing (with the front wheels on the ground) is not allowed, as transmission damage will occur. If rear towing is the only alternative, the front wheels must be placed on a towing dolly. Proper towing equipment is necessary to prevent damage to the vehicle.

#### All-Wheel Drive (AWD)

The manufacturer requires towing your vehicle with all four wheels OFF the ground using a flatbed.

### CAUTION!

**Failure to follow these towing methods could result in damage to the transmission and/or transfer case. Such damage is not covered by the New Vehicle Limited Warranty.**

# SECTION 7

## MAINTAINING YOUR VEHICLE

• ENGINE COMPARTMENT — 2.4L . . . . .	345	• Exhaust System . . . . .	359
• ENGINE COMPARTMENT – 3.6L . . . . .	346	• Cooling System . . . . .	361
• ONBOARD DIAGNOSTIC SYSTEM — OBD II . . . . .	347	• Brake System . . . . .	365
• Loose Fuel Filler Cap Message . . . . .	347	• Automatic Transmission . . . . .	367
• EMISSIONS INSPECTION AND MAINTENANCE PROGRAMS . . . . .	347	• Rear Drive Assembly (RDA) – AWD Models Only . . . . .	369
• REPLACEMENT PARTS . . . . .	349	• Power Transfer Unit (PTU) – AWD Models Only . . . . .	370
• DEALER SERVICE . . . . .	349	• Appearance Care and Protection from Corrosion . . . . .	370
• MAINTENANCE PROCEDURES . . . . .	349	• Cleaning The Cupholders . . . . .	374
• Engine Oil . . . . .	350	• FUSES . . . . .	374
• Engine Oil Filter . . . . .	353	• Interior Fuses . . . . .	374
• Engine Air Cleaner Filter . . . . .	353	• Underhood Fuses (Power Distribution Center) . . . . .	376
• Maintenance-Free Battery . . . . .	353	• VEHICLE STORAGE . . . . .	379
• Air Conditioner Maintenance . . . . .	355	• REPLACEMENT BULBS . . . . .	379
• A/C Air Filter – If Equipped . . . . .	356	• BULB REPLACEMENT . . . . .	380
• Body Lubrication . . . . .	357		
• Wiper Blades . . . . .	357		
• Adding Washer Fluid . . . . .	359		

**MAINTAINING YOUR VEHICLE**

- Front Low/High Beam Headlamp, Turn Signal/Park Lamp, and Side Marker Lamp . . . 380
- Front Fog Lamp . . . . . 381
- Rear Turn Signal and Backup Lamp . . . . . 381
- License Plate Lamp . . . . . 383
- FLUID CAPACITIES . . . . . 383
- FLUIDS, LUBRICANTS, AND GENUINE PARTS . . 385
  - Engine . . . . . 385
  - Chassis . . . . . 385

## ENGINE COMPARTMENT — 2.4L

art=070307227.tif NO TRANS

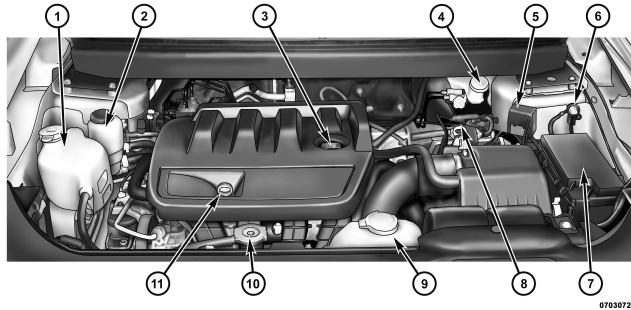

- 1 — Engine Coolant Reservoir
- 2 — Power Steering Fluid Reservoir
- 3 — Engine Oil Fill
- 4 — Brake Fluid Reservoir
- 5 — Remote Jump Start (Positive Battery Post)
- 6 — Remote Jump Start (Negative Battery Post)

- 7 — Totally Integrated Power Module (Fuses)
- 8 — Automatic Transmission Dipstick
- 9 — Washer Fluid Reservoir
- 10 — Coolant Pressure Cap
- 11 — Engine Oil Dipstick

**MAINTAINING YOUR VEHICLE**

**ENGINE COMPARTMENT – 3.6L**

art=074410806.tif NO TRANS

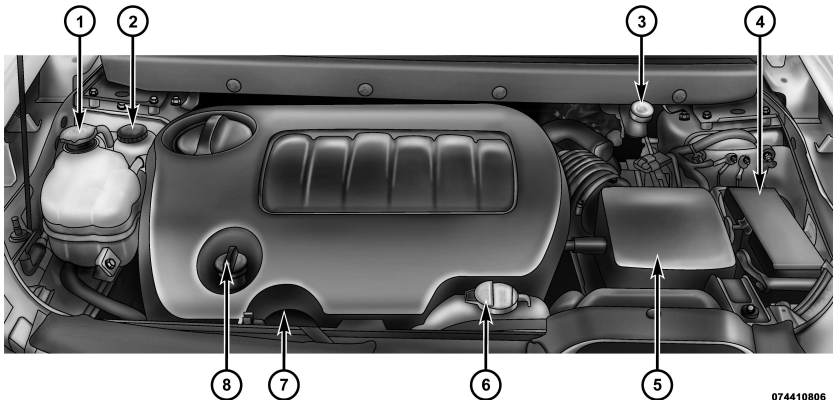

- 1 — Engine Coolant Reservoir
- 2 — Power Steering Fluid Reservoir
- 3 — Brake Fluid Reservoir
- 4 — Totally Integrated Power Module (Fuses)
- 5 — Air Cleaner Filter
- 6 — Washer Fluid Reservoir
- 7 — Engine Oil Dipstick
- 8 — Engine Oil Fill

## **ONBOARD DIAGNOSTIC SYSTEM — OBD II**

Your vehicle is equipped with a sophisticated onboard diagnostic system called OBD II. This system monitors the performance of the emissions, engine, and automatic transmission control systems. When these systems are operating properly, your vehicle will provide excellent performance and fuel economy, as well as engine emissions well within current government regulations.

If any of these systems require service, the OBD II system will turn on the “Malfunction Indicator Light” (MIL). It will also store diagnostic codes and other information to assist your service technician in making repairs. Although your vehicle will usually

be drivable and not need towing, see your authorized dealer for service as soon as possible.

### **CAUTION!**

- **Prolonged driving with the MIL on could cause further damage to the emission control system. It could also affect fuel economy and drivability. The vehicle must be serviced before any emissions tests can be performed.**
- **If the MIL is flashing while the engine is running, severe catalytic converter damage and power loss will soon occur. Immediate service is required.**

### **Loose Fuel Filler Cap Message**

If the vehicle diagnostic system determines that the fuel filler cap is loose, improperly installed, or damaged, the word “gASCAP” will display in the odometer. If this occurs, tighten the fuel filler cap until a “clicking” sound is heard and press the TRIP ODOMETER button to turn off the message. If the problem persists, the message will appear the next time the vehicle is started.

A loose, improperly installed, or damaged fuel filler cap may also turn on the MIL.

## **EMISSIONS INSPECTION AND MAINTENANCE PROGRAMS**

In some localities, it may be a legal requirement to pass an inspection of your vehicle’s emissions control system. Failure to pass could prevent vehicle registration.

## MAINTAINING YOUR VEHICLE

art=072100435.tif NO TRANS



For provinces that require an Inspection and Maintenance (I/M), this check verifies the Malfunction Indicator Light (MIL) is functioning and is not on when the engine is running, and that the OBD II system is ready for testing.

Normally, the OBD II system will be ready. The OBD II system may **not** be ready if your vehicle was recently serviced, recently had a dead battery or a battery replacement. If the OBD II system should be determined not ready for the I/M test, your vehicle may fail the test.

Your vehicle has a simple ignition key-actuated test, which you can use prior to going to the test station. To check if your vehicle's OBD II system is ready, you must do the following:

1. Insert your ignition key into the ignition switch.
2. Turn the ignition switch to the ON position, but do not crank or start the engine.
3. If you crank or start the engine, you will have to start this test over.
4. As soon as you turn the ignition switch to the ON position, you will see the MIL symbol come on as part of a normal bulb check.
5. Approximately 15 seconds later, one of two things will happen:
  - a. The MIL will flash for about 10 seconds and then return to being fully illuminated until you turn OFF the ignition or start the engine. This means that your vehicle's OBD II system is **not**

**ready** and you should **not** proceed to the I/M station.

b. The MIL will not flash at all and will remain fully illuminated until you turn OFF the ignition or start the engine. This means that your vehicle's OBD II system is **ready** and you can proceed to the I/M station.

If your OBD II system is **not ready**, you should see your authorized dealer or repair facility. If your vehicle was recently serviced or had a battery failure or replacement, you may need to do nothing more than drive your vehicle as you normally would in order for your OBD II system to update. A recheck with the above test routine may then indicate that the system is now ready.



**MAINTAINING YOUR VEHICLE**

Regardless of whether your vehicle's OBD II system is ready or not, if the MIL is illuminated during normal vehicle operation you should have your vehicle serviced before going to the I/M station. The I/M station can fail your vehicle because the MIL is on with the engine running.

**REPLACEMENT PARTS**

Use of genuine MOPAR® parts for normal/scheduled maintenance and repairs is highly recommended to ensure the designed performance. Damage or failures caused by the use of non-MOPAR® parts for maintenance and repairs will not be covered by the manufacturer's warranty.

**DEALER SERVICE**

Your authorized dealer has the qualified service personnel, special tools, and equipment to perform all service opera-

tions in an expert manner. Service Manuals are available which include detailed service information for your vehicle. Refer to these Service Manuals before attempting any procedure yourself.

**NOTE:** *Intentional tampering with emissions control systems may void your warranty and could result in civil penalties being assessed against you.*

**WARNING!**

**You can be badly injured working on or around a motor vehicle. Only do service work for which you have the knowledge and the proper equipment. If you have any doubt about your ability to perform a service job, take your vehicle to a competent mechanic.**

**MAINTENANCE PROCEDURES**

The pages that follow contain the **required** maintenance services determined by the engineers who designed your vehicle.

Besides those maintenance items specified in the fixed maintenance schedule, there are other components which may require servicing or replacement in the future.

## MAINTAINING YOUR VEHICLE

### CAUTION!

- Failure to properly maintain your vehicle or perform repairs and service when necessary could result in more costly repairs, damage to other components or negatively impact vehicle performance. Immediately have potential malfunctions examined by an authorized Chrysler Group LLC dealership or qualified repair center.

- Your vehicle has been built with improved fluids that protect the performance and durability of your vehicle and also allow extended maintenance intervals. Do not use chemical flushes in these components as the chemicals can damage your engine, transmission, power steering or air conditioning. Such damage is not covered by the New Vehicle Limited Warranty. If a flush is needed because of component malfunction, use only the specified fluid for the flushing procedure.

### Engine Oil

#### Checking Oil Level

To assure proper engine lubrication, the engine oil must be maintained at the cor-

rect level. Check the oil level at regular intervals, such as every fuel stop. The best time to check the engine oil level is about five minutes after a fully warmed engine is shut off. Do not check oil level before starting the engine after it has sat overnight. Checking engine oil level when the engine is cold will give you an incorrect reading.

Checking the oil while the vehicle is on level ground and only when the engine is hot, will improve the accuracy of the oil level readings. Maintain the oil level between the range markings on the dipstick. Either the range markings consist of a crosshatch zone marked SAFE or a crosshatch zone marked with MIN at the low end of the range and MAX at the high end of the range. Adding 1.0 qt (1.0 l) of oil when the reading is at the low end of the

**MAINTAINING YOUR VEHICLE**

range marking will raise the oil level to the high end of the range marking.

**CAUTION!**

**Do not overfill the engine. Overfilling the engine will cause oil aeration, which can lead to loss of oil pressure and an increase in oil temperature. This could damage your engine. Also, be sure the oil fill cap is replaced and tightened after adding oil.**

**Change Engine Oil**

The oil change indicator system will remind you that it is time to take your vehicle in for scheduled maintenance. Refer to the "Maintenance Schedule" for further information.

**NOTE: Under no circumstances should oil change intervals exceed 8,000 miles (13 000 km) or six months, whichever occurs first.**

**Engine Oil Selection**

For best performance and maximum protection under all types of operating conditions, the manufacturer only recommends engine oils that are API Certified and meet the requirements of Chrysler Material Standard MS-6395.

**American Petroleum Institute (API) Engine Oil Identification Symbol**



certified engine oils.

This symbol means that the oil has been certified by the American Petroleum Institute (API). The manufacturer only recommends API Cer-

## MAINTAINING YOUR VEHICLE

### CAUTION!

**Do not use chemical flushes in your engine oil as the chemicals can damage your engine. Such damage is not covered by the New Vehicle Limited Warranty.**

#### Engine Oil Viscosity – 2.4L Engine

SAE 5W-20 engine oil is recommended for all operating temperatures. This engine oil improves low temperature starting and vehicle fuel economy.

The engine oil filler cap also shows the recommended engine oil viscosity for your engine. For information on the engine oil filler cap location, refer to “Engine Compartment” in “Maintaining Your Vehicle” for further information.

Lubricants that do not have both, the engine oil certification mark and the correct SAE viscosity grade number should not be used.

#### Engine Oil Viscosity – 3.6L Engine

SAE 5W-30 engine oil is recommended for all operating temperatures. This engine oil improves low temperature starting and vehicle fuel economy.

The engine oil filler cap also shows the recommended engine oil viscosity for your vehicle. For information on engine oil filler cap location, refer to “Engine Compartment” in “Maintaining Your Vehicle” for further information.

Lubricants, which do not have both the engine oil certification mark and the correct SAE viscosity grade number, should not be used.

#### Synthetic Engine Oils

You may use synthetic engine oils provided the recommended oil quality requirements are met, and the recommended maintenance intervals for oil and filter changes are followed.

#### Materials Added to Engine Oil

Do not add any supplemental materials, other than leak detection dyes, to your engine oil. Engine oil is an engineered product and its performance may be impaired by supplemental additives.

#### Disposing of Used Engine Oil and Oil Filters

Care should be taken in disposing of used engine oil and oil filters from your vehicle. Used oil and oil filters, indiscriminately discarded, can present a problem to the environment. Contact your authorized dealer, service station, or governmental

**MAINTAINING YOUR VEHICLE**

agency for advice on how and where used oil and oil filters can be safely discarded in your area.

**Engine Oil Filter**

The engine oil filter should be replaced with a new filter at every engine oil change.

**Engine Oil Filter Selection**

This manufacturer's engines have a full-flow type disposable oil filter. Use a filter of this type for replacement. The quality of replacement filters varies considerably. Only high quality filters should be used to assure most efficient service. MOPAR® engine oil filters are high quality oil filters and are recommended.

**Engine Air Cleaner Filter**

Refer to the "Maintenance Schedule" for the proper maintenance intervals.

**WARNING!**

**The air induction system (air cleaner, hoses, etc.) can provide a measure of protection in the case of engine backfire. Do not remove the air induction system (air cleaner, hoses, etc.) unless such removal is necessary for repair or maintenance. Make sure that no one is near the engine compartment before starting the vehicle with the air induction system (air cleaner, hoses, etc.) removed. Failure to do so can result in serious personal injury.**

**Engine Air Cleaner Filter Selection**

The quality of replacement engine air cleaner filters varies considerably. Only high quality filters should be used to assure most efficient service. MOPAR® en-

gine air cleaner filters are a high quality filter and are recommended.

**Maintenance-Free Battery**

Your vehicle is equipped with a maintenance-free battery. You will never have to add water, nor is periodic maintenance required.

**NOTE:** *The battery is stored in a compartment that is located behind the left front fender and is accessible through the wheel well. The wheel and tire assemble do not need to be removed to access the compartment. Remote battery terminals are located in the engine compartment for jump-starting. Refer to "Jump-Starting Procedures" in "What To Do In Emergencies" for further information.*

## MAINTAINING YOUR VEHICLE

To access the battery, turn the steering wheel fully to the right and remove the access panel from the inner fender shield.

### WARNING!

- Battery fluid is a corrosive acid solution and can burn or even blind you. Do not allow battery fluid to contact your eyes, skin, or clothing. Do not lean over a battery when attaching clamps. If acid splashes in eyes or on skin, flush the area immediately with large amounts of water.

- Battery gas is flammable and explosive. Keep flame or sparks away from the battery. Do not use a booster battery or any other booster source with an output greater than 12 Volts. Do not allow cable clamps to touch each other.
- Battery posts, terminals, and related accessories contain lead and lead compounds. Wash hands after handling.

### CAUTION!

- It is essential when replacing the cables on the battery that the positive cable is attached to the positive post and the negative cable is attached to the negative post. Battery posts are marked positive (+) and negative (-) and are identified on the battery case. Cable clamps should be tight on the terminal posts and free of corrosion.
- If a “fast charger” is used while the battery is in the vehicle, disconnect both vehicle battery cables before connecting the charger to the battery. Do not use a “fast charger” to provide starting voltage.

**MAINTAINING YOUR VEHICLE**

**Air Conditioner Maintenance**

For best possible performance, your air conditioner should be checked and serviced by an authorized dealer at the start of each warm season. This service should include cleaning of the condenser fins and a performance test. Drive belt tension should also be checked at this time.

**CAUTION!**

**Do not use chemical flushes in your air conditioning system as the chemicals can damage your air conditioning components. Such damage is not covered by the New Vehicle Limited Warranty.**

**WARNING!**

- **Use only refrigerants and compressor lubricants approved by the manufacturer for your air conditioning system. Some unapproved refrigerants are flammable and can explode, injuring you. Other unapproved refrigerants or lubricants can cause the system to fail, requiring costly repairs. Refer to Warranty Information Book, located on the DVD, for further warranty information.**

- **The air conditioning system contains refrigerant under high pressure. To avoid risk of personal injury or damage to the system, adding refrigerant or any repair requiring lines to be disconnected should be done by an experienced technician.**

**Refrigerant Recovery and Recycling**

R-134a Air Conditioning Refrigerant is a hydrofluorocarbon (HFC) that is endorsed by the Environmental Protection Agency and is an ozone-saving product. However, the manufacturer recommends that air conditioning service be performed by authorized dealers or other service facilities using recovery and recycling equipment.

## MAINTAINING YOUR VEHICLE

**NOTE:** Use only manufacturer approved A/C system sealers, stop leak products, seal conditioners, compressor oil, and refrigerants.

### A/C Air Filter – If Equipped

Refer to the "Maintenance Schedule" for the proper maintenance intervals.

#### WARNING!

**Do not remove the A/C air filter while the blower is operating or personal injury may result.**

The A/C air filter is located in the fresh air inlet behind the glove box. Perform the following steps to replace the filter:

1. Open the glove box and remove all contents.

2. Push the retaining tab on each side of the glove box inward while gently pulling the glove box door outward until both tabs clear the door opening in the instrument panel.

art=072606060.tif NO TRANS

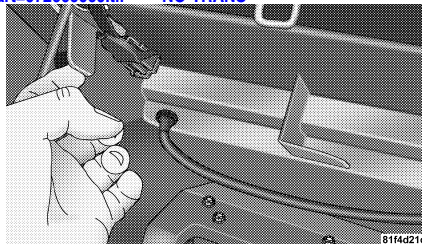

Glove Box Removal

3. Pivot the glove box downward.

4. Disengage the two retaining tabs that secure the filter cover to the HVAC housing and remove the cover.

art=072600634.tif NO TRANS

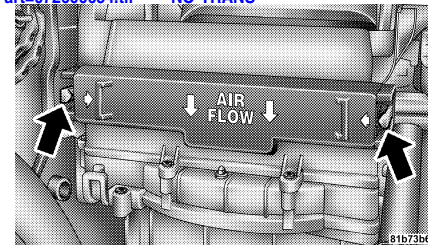

A/C Air Filter Replacement

5. Remove the A/C air filter by pulling it straight out of the housing.

6. Install the A/C air filter with the arrow on the filter pointing toward the floor. When installing the filter cover, make sure the retaining tabs fully engage the cover.



**MAINTAINING YOUR VEHICLE**

**CAUTION!**

**The A/C air filter is identified with an arrow to indicate airflow direction through the filter. Failure to install the filter properly will result in the need to replace it more often.**

7. Reinstall the glove box door. Make sure that the hinges are seated fully as you raise the door. Otherwise, the door latch will not align properly.

**Body Lubrication**

Locks and all body pivot points, including such items as seat tracks, door hinge pivot points and rollers, liftgate, tailgate, sliding doors and hood hinges, should be lubricated periodically with a lithium based grease, such as MOPAR® Spray White Lube or equivalent to assure quiet,

easy operation and to protect against rust and wear. Prior to the application of any lubricant, the parts concerned should be wiped clean to remove dust and grit; after lubricating excess oil and grease should be removed. Particular attention should also be given to hood latching components to ensure proper function. When performing other underhood services, the hood latch, release mechanism and safety catch should be cleaned and lubricated.

The external lock cylinders should be lubricated twice a year, preferably in the Fall and Spring. Apply a small amount of a high quality lubricant, such as MOPAR® Lock Cylinder Lubricant or equivalent directly into the lock cylinder.

**Wiper Blades**

Clean the rubber edges of the wiper blades and the windshield and rear win-

dow periodically with a sponge or soft cloth and a mild nonabrasive cleaner. This will remove accumulations of salt, waxes, or road film, and help reduce streaking and smearing.

Operation of the wipers on dry glass for long periods may cause deterioration of the wiper blades. Always use washer fluid when using the wipers to remove salt or dirt from a dry windshield or rear window.

Avoid using the wiper blades to remove frost or ice from the windshield or rear window. Make sure that they are not frozen to the glass before turning them on to avoid damaging the blade. Keep the blade rubber out of contact with petroleum products such as engine oil, gasoline, etc.

**NOTE:** *Life expectancy of wiper blades varies depending on geographical area*

**MAINTAINING YOUR VEHICLE**

and frequency of use. Poor performance of blades may be present with chattering, marks, water lines or wet spots. If any of these conditions are present, clean the wiper blades or replace as necessary.

**Rear Wiper Blade Removal/Installation**

1. Lift the pivot cap on the rear wiper arm upward, this will allow the rear wiper blade to be raised off of the liftgate glass.

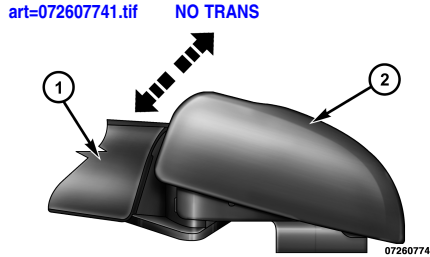

- 1 — Wiper Arm
- 2 — Pivot Cap

**NOTE:** The rear wiper arm cannot be raised fully upward unless the pivot cap is raised first.

2. Lift the rear wiper arm upward to raise the wiper blade off of the liftgate glass.

3. Grab the bottom of the wiper blade and rotate it forward to unsnap the blade pivot pin from the wiper blade holder.

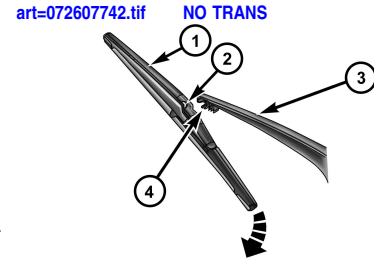

- 1 — Wiper Blade
- 2 — Blade Pivot Pin
- 3 — Wiper Arm
- 4 — Wiper Blade Holder

4. Install the wiper blade pivot pin into the wiper blade holder at the end of the wiper

**MAINTAINING YOUR VEHICLE**

arm, and firmly press the wiper blade until it snaps into place.

5. Lower the wiper blade and snap the pivot cap into place.

**Adding Washer Fluid**

The windshield washer and the rear window washer share the same fluid reservoir. The fluid reservoir is located in the engine compartment. Be sure to check the fluid level in the reservoir at regular intervals. Fill the reservoir with windshield washer solvent (not radiator antifreeze) and operate the system for a few seconds to flush out the residual water.

When refilling the washer fluid reservoir, apply some washer fluid to a cloth or towel and wipe the wiper blades clean. This will help blade performance.

To prevent freeze-up of your windshield washer system in cold weather, select a solution or mixture that meets or exceeds the temperature range of your climate. This rating information can be found on most washer fluid containers.

The fluid reservoir will hold nearly 1 gal (4 l) of washer fluid when the message “LoWASH” appears in the instrument cluster.

**WARNING!**  
**Commercially available windshield washer solvents are flammable. They could ignite and burn you. Care must be exercised when filling or working around the washer solution.**

**Exhaust System**

The best protection against carbon monoxide entry into the vehicle body is a properly maintained engine exhaust system.

If you notice a change in the sound of the exhaust system; or if the exhaust fumes can be detected inside the vehicle; or when the underside or rear of the vehicle is damaged; have an authorized technician inspect the complete exhaust system and adjacent body areas for broken, damaged, deteriorated, or mispositioned parts. Open seams or loose connections could permit exhaust fumes to seep into the passenger compartment. In addition, inspect the exhaust system each time the vehicle is raised for lubrication or oil change. Replace as required.

**MAINTAINING YOUR VEHICLE**

**WARNING!**

- Exhaust gases can injure or kill. They contain carbon monoxide (CO), which is colorless and odorless. Breathing it can make you unconscious and can eventually poison you. To avoid breathing CO, refer to “Safety Tips/Exhaust Gas” in “Things To Know Before Starting Your Vehicle” for further information.

- A hot exhaust system can start a fire if you park over materials that can burn. Such materials might be grass or leaves coming into contact with your exhaust system. Do not park or operate your vehicle in areas where your exhaust system can contact anything that can burn.

**CAUTION!**

- The catalytic converter requires the use of unleaded fuel only. Leaded gasoline will destroy the effectiveness of the catalyst as an emissions control device and may seriously reduce engine performance and cause serious damage to the engine.

- Damage to the catalytic converter can result if your vehicle is not kept in proper operating condition. In the event of engine malfunction, particularly involving engine misfire or other apparent loss of performance, have your vehicle serviced promptly. Continued operation of your vehicle with a severe malfunction could cause the converter to overheat, resulting in possible damage to the converter and vehicle.

Under normal operating conditions, the catalytic converter will not require maintenance. However, it is important to keep the engine properly tuned to assure proper catalyst operation and prevent possible catalyst damage.

**MAINTAINING YOUR VEHICLE**

**NOTE:** *Intentional tampering with emissions control systems can result in civil penalties being assessed against you.*

In unusual situations involving grossly malfunctioning engine operation, a scorching odor may suggest severe and abnormal catalyst overheating. If this occurs, stop the vehicle, turn off the engine and allow it to cool. Service, including a tune-up to manufacturer's specifications, should be obtained immediately.

To minimize the possibility of catalytic converter damage:

- Do not shut off the engine or interrupt the ignition, when the transmission is in gear and the vehicle is in motion.
- Do not try to start the engine by pushing or towing the vehicle.

- Do not idle the engine with any spark plug wires disconnected or removed, such as when diagnostic testing, or for prolonged periods during very rough idle or malfunctioning operating conditions.

**Cooling System**

**WARNING!**

- **When working near the radiator cooling fan, disconnect the fan motor lead or turn the ignition switch to the LOCK position. The fan is temperature controlled and can start at any time the ignition switch is in the ON position.**

- **You or others can be badly burned by hot coolant or steam from your radiator. If you see or hear steam coming from under the hood, do not open the hood until the radiator has had time to cool. Never try to open a cooling system pressure cap when the radiator is hot.**

**Coolant Checks**

Check the engine coolant (antifreeze) protection every 12 months (before the onset of freezing weather, where applicable). If the engine coolant (antifreeze) is dirty or rusty in appearance, the system should be drained, flushed, and refilled with fresh engine coolant (antifreeze). Check the front of the A/C condenser for any accumulation of bugs, leaves, etc. If dirty, clean

## MAINTAINING YOUR VEHICLE

by gently spraying water from a garden hose vertically down the face of the condenser.

Check the coolant recovery bottle tubing for brittle rubber, cracking, tears, cuts, and tightness of the connection at the bottle and radiator. Inspect the entire system for leaks.

### Cooling System – Drain, Flush, and Refill

Refer to the “Maintenance Schedule” for the proper maintenance intervals.

If the engine coolant (antifreeze) is dirty or contains a considerable amount of sediment, clean and flush with a reliable cooling system cleaner. Follow with a thorough rinsing to remove all deposits and chemicals. Properly dispose of the old engine coolant (antifreeze).

### Selection of Coolant

Use only the manufacturer’s recommended engine coolant (antifreeze). Refer to “Fluids, Lubricants, and Genuine Parts” in “Maintaining Your Vehicle” for further information.

#### CAUTION!

- **Mixing of engine coolant (antifreeze) other than specified HOAT engine coolant (antifreeze), may result in engine damage and may decrease corrosion protection. If a non-HOAT engine coolant (antifreeze) is introduced into the cooling system in an emergency, it should be replaced with the specified engine coolant (antifreeze) as soon as possible.**

- **Do not use water alone or alcohol-based engine coolant (antifreeze) products. Do not use additional rust inhibitors or antirust products, as they may not be compatible with the radiator engine coolant (antifreeze) and may plug the radiator.**
- **This vehicle has not been designed for use with propylene glycol-based engine coolant (antifreeze). Use of propylene glycol-based engine coolant (antifreeze) is not recommended.**

### Adding Coolant

Your vehicle has been built with an improved engine coolant (antifreeze) that allows extended maintenance intervals. This engine coolant (antifreeze) can be

## MAINTAINING YOUR VEHICLE

used up to five years or 104,000 miles (169 000 km) before replacement. To prevent reducing this extended maintenance period, it is important that you use the same engine coolant (antifreeze) throughout the life of your vehicle.

Please review these recommendations for using Hybrid Organic Additive Technology (HOAT) engine coolant (antifreeze). When adding engine coolant (antifreeze):

- The manufacturer recommends using MOPAR® Antifreeze/Coolant 5 Year/100,000 Mile Formula HOAT (Hybrid Organic Additive Technology) or equivalent.
- Mix a minimum solution of 50% HOAT engine coolant and distilled water. Use higher concentrations (not to exceed

70%) if temperatures below  $-34^{\circ}\text{F}$  ( $-37^{\circ}\text{C}$ ) are anticipated.

- Use only high purity water such as distilled or deionized water when mixing the water/engine coolant (antifreeze) solution. The use of lower quality water will reduce the amount of corrosion protection in the engine cooling system.

Please note that it is the owner's responsibility to maintain the proper level of protection against freezing according to the temperatures occurring in the area where the vehicle is operated.

**NOTE:** *Mixing engine coolant (antifreeze) types will decrease the life of the engine coolant (antifreeze) and will require more frequent coolant changes.*

### Cooling System Pressure Cap

The cap must be fully tightened to prevent loss of engine coolant (antifreeze), and to ensure that engine coolant (antifreeze) will return to the radiator from the coolant recovery bottle.

The cap should be inspected and cleaned if there is any accumulation of foreign material on the sealing surfaces.

**MAINTAINING YOUR VEHICLE**

**WARNING!**

- **The warning words “DO NOT OPEN HOT” on the cooling system pressure cap are a safety precaution. Never add engine coolant (antifreeze) when the engine is overheated. Do not loosen or remove the cap to cool an overheated engine. Heat causes pressure to build up in the cooling system. To prevent scalding or injury, do not remove the pressure cap while the system is hot or under pressure.**
- **Do not use a pressure cap other than the one specified for your vehicle. Personal injury or engine damage may result.**

**Disposal of Used Coolant**

Used ethylene glycol-based engine coolant (antifreeze) is a regulated substance requiring proper disposal. Check with your local authorities to determine the disposal rules for your community. To prevent ingestion by animals or children, do not store ethylene glycol-based engine coolant (antifreeze) in open containers or allow it to remain in puddles on the ground. If ingested by a child or pet, seek emergency assistance immediately. Clean up any ground spills immediately.

**Coolant Level**

**2.4L Engine** – the coolant bottle provides a quick visual method for determining that the coolant level is adequate. With the engine idling and warm to normal operating temperature, the level of the coolant in

the bottle should be between the “ADD” and “FULL” lines, shown on the bottle.

**3.6L Engine** – the level of the coolant in the pressurized coolant bottle should be between the “COLD” and “FULL” range on the bottle when the engine is cold.

The radiator normally remains completely full, so there is no need to remove the radiator cap unless checking for coolant freeze point or replacing engine coolant (antifreeze). Advise your service attendant of this. As long as the engine operating temperature is satisfactory, the coolant bottle need only be checked once a month. When additional engine coolant (antifreeze) is needed to maintain the proper level, it should be added to the coolant bottle. Do not overfill.



---

## MAINTAINING YOUR VEHICLE

### Points To Remember

**NOTE:** *When the vehicle is stopped after a few miles (kilometers) of operation, you may observe vapor coming from the front of the engine compartment. This is normally a result of moisture from rain, snow, or high humidity accumulating on the radiator and being vaporized when the thermostat opens, allowing hot engine coolant (antifreeze) to enter the radiator.*

If an examination of your engine compartment shows no evidence of radiator or hose leaks, the vehicle may be safely driven. The vapor will soon dissipate.

- Do not overfill the coolant recovery bottle.
- Check the engine coolant (antifreeze) freeze point in the radiator and in the

coolant recovery bottle. If engine coolant (antifreeze) needs to be added, the contents of coolant recovery bottle must also be protected against freezing.

- If frequent engine coolant (antifreeze) additions are required, or if the level in the coolant recovery bottle does not drop when the engine cools, the cooling system should be pressure tested for leaks.
- Maintain engine coolant (antifreeze) concentration at 50% HOAT engine coolant (antifreeze) (minimum) and distilled water for proper corrosion protection of your engine, which contains aluminum components.

- Make sure that the radiator and coolant recovery bottle overflow hoses are not kinked or obstructed.
- Keep the front of the radiator clean. If your vehicle is equipped with air conditioning, keep the front of the condenser clean.
- Do not change the thermostat for Summer or Winter operation. If replacement is ever necessary, install ONLY the correct type thermostat. Other designs may result in unsatisfactory engine coolant (antifreeze) performance, poor gas mileage, and increased emissions.

### Brake System

In order to assure brake system performance, all brake system components should be inspected periodically. Refer to

## MAINTAINING YOUR VEHICLE

the "Maintenance Schedule" for the proper maintenance intervals.

### WARNING!

**Riding the brakes can lead to brake failure and possibly a collision. Driving with your foot resting or riding on the brake pedal can result in abnormally high brake temperatures, excessive lining wear, and possible brake damage. You would not have your full braking capacity in an emergency.**

### Master Cylinder – Brake Fluid Level Check

Check the fluid level in the master cylinder immediately if the "Brake Warning Light" indicates system failure.

Check the fluid level in the master cylinder when performing underhood services.

Clean the top of the master cylinder area before removing the cap. If necessary, add fluid to bring the fluid level up to the requirements described on the brake fluid reservoir.

Overfilling of fluid is not recommended because it may cause leaking in the system.

Fluid level can be expected to fall as the brake pads wear. Brake fluid level should be checked when pads are replaced. However, low fluid level may be caused by a leak and a checkup may be needed.

Use only manufacturer's recommended brake fluid. Refer to "Fluids, Lubricants,

and Genuine Parts" in "Maintaining Your Vehicle" for further information.

### WARNING!

- **Use only manufacturer's recommended brake fluid. Refer to "Fluids, Lubricants, and Genuine Parts" in "Maintaining Your Vehicle" for further information. Using the wrong type of brake fluid can severely damage your brake system and/or impair its performance. The proper type of brake fluid for your vehicle is also identified on the original factory installed hydraulic master cylinder reservoir.**

---

## MAINTAINING YOUR VEHICLE

- **To avoid contamination from foreign matter or moisture, use only new brake fluid or fluid that has been in a tightly closed container. Keep the master cylinder reservoir cap secured at all times. Brake fluid in an open container absorbs moisture from the air resulting in a lower boiling point. This may cause it to boil unexpectedly during hard or prolonged braking, resulting in sudden brake failure. This could result in a collision.**

- **Overfilling the brake fluid reservoir can result in spilling brake fluid on hot engine parts, causing the brake fluid to catch fire. Brake fluid can also damage painted and vinyl surfaces, care should be taken to avoid its contact with these surfaces.**
- **Do not allow petroleum based fluid to contaminate the brake fluid. Brake seal components could be damaged, causing partial or complete brake failure. This could result in a collision.**

### Automatic Transmission

The automatic transmission and differential assembly are contained within a single housing.

The fluid level in the automatic transmission should be checked whenever the vehicle is serviced. Operation with an improper fluid level will greatly reduce the life of the transmission and the fluid.

### Selection of Lubricant

It is important that the proper lubricant is used in the transmission to assure optimum transmission performance. Use only manufacturer's recommended transmission fluid. Refer to "Fluids, Lubricants, and Genuine Parts" in "Maintaining Your Vehicle" for further information. It is important that the transmission fluid be maintained at the prescribed level using the recommended fluid. No chemical flushes should be used in any transmission; only the approved lubricant may be used.

**MAINTAINING YOUR VEHICLE**

**Special Additives**

Automatic Transmission Fluid (ATF) is an engineered product and its performance may be impaired by supplemental additives. Therefore, do not add any fluid additives to the transmission. The only exception to this policy is the use of special dyes to aid in detecting fluid leaks. In addition, avoid using transmission sealers as they may adversely affect seals.

**CAUTION!**

**Do not use chemical flushes in your transmission as the chemicals can damage your transmission components. Such damage is not covered by the New Vehicle Limited Warranty.**

**Fluid Level Check – 2.4L Engine**

Use the following procedure to check the automatic transmission fluid level properly:

1. Park the vehicle on level ground.
2. Run the engine at curb idle speed for a minimum of 60 seconds.
3. Apply the parking brake fully.
4. Place the shift lever momentarily in each gear position ending with the lever in PARK.
5. Wipe the area around the dipstick clean to eliminate the possibility of dirt entering the transmission.
6. Remove the dipstick and determine if the fluid is hot or cold. Hot fluid is approximately 180°F (82°C), which is the normal

operating temperature after the vehicle is driven at least 15 miles (24 km). Hot fluid cannot be held comfortably between the fingertips. Cold fluid is at a temperature below 80°F (27°C).

7. Wipe the dipstick clean and reinsert until seated. Then, remove dipstick and note the reading.

a. If the fluid is hot, the reading should be in the crosshatched area marked "HOT" (between the upper two holes in the dipstick).

b. If the fluid is cold, the fluid level should be between the lower two holes in the area marked "COLD."

If the fluid level is low, add sufficient fluid through the filler (dipstick) tube to bring it to the proper level. Do not overfill.

**CAUTION!**

- **Using a transmission fluid other than the manufacturer's recommended fluid may cause deterioration in transmission shift quality and/or torque converter shudder. Using a transmission fluid other than that recommended by the manufacturer will result in more frequent fluid and filter changes. Refer to "Fluids, Lubricants, and Genuine Parts" in "Maintaining Your Vehicle" for further information.**

- **Dirt and water in the transmission can cause serious damage. To prevent dirt and water from entering the transmission after checking or replenishing fluid, make certain that the dipstick cap is re-seated properly.**

**Fluid Level Check – 3.6L Engine**

The automatic transmission has no dipstick and is dealer serviced only.

**Fluid and Filter Changes**

Refer to the "Maintenance Schedule" for the proper maintenance intervals

In addition, change the fluid and filter if the transmission is disassembled for any reason.

**Rear Drive Assembly (RDA) – AWD Models Only**

**Lubricant Selection**

Use only the manufacturer's recommended fluid. Refer to "Fluids, Lubricants, and Genuine Parts" in "Maintaining Your Vehicle" for further information.

**Fluid Level Check**

Visually inspect the unit at each oil change for leakage. If leakage is detected, check the fluid level by removing the fill plug. The fluid level should be maintained between the bottom of the fill hole to 1/8 in (4 mm) below the fill hole.

Add fluid, if necessary, to maintain the proper level.

## MAINTAINING YOUR VEHICLE

### Frequency Of Fluid Change

Refer to the "Maintenance Schedule" for the proper maintenance intervals.

### Power Transfer Unit (PTU) – AWD Models Only

#### Lubricant Selection

Use only the manufacturer's recommended fluid. Refer to "Fluids, Lubricants, and Genuine Parts" in "Maintaining Your Vehicle" for further information.

#### Fluid Level Check

Visually inspect the unit at each oil change for leakage. If leakage is detected, Check the fluid level by removing the fill plug. The fluid level should be maintained between the bottom of the fill hole to 1/8 in (4 mm) below the fill hole.

Add fluid, if necessary, to maintain the proper level.

### Frequency Of Fluid Change

Refer to the "Maintenance Schedule" for the proper maintenance intervals.

### Appearance Care and Protection from Corrosion

#### Protection of Body and Paint from Corrosion

Vehicle body care requirements vary according to geographic locations and usage. Chemicals that make roads passable in snow and ice and those that are sprayed on trees and road surfaces during other seasons are highly corrosive to the metal in your vehicle. Outside parking, which exposes your vehicle to airborne contaminants, road surfaces on which the vehicle is operated, extreme hot or cold

weather and other extreme conditions will have an adverse effect on paint, metal trim, and underbody protection.

The following maintenance recommendations will enable you to obtain maximum benefit from the corrosion resistance built into your vehicle.

#### What Causes Corrosion?

Corrosion is the result of deterioration or removal of paint and protective coatings from your vehicle.

The most common causes are:

- Road salt, dirt, and moisture accumulation.
- Stone and gravel impact.
- Insects, tree sap, and tar.
- Salt in the air near seacoast localities.

## MAINTAINING YOUR VEHICLE

- Atmospheric fallout/industrial pollutants.

### Washing

- Wash your vehicle regularly. Always wash your vehicle in the shade using MOPAR® Car Wash or a mild car wash soap, and rinse the panels completely with clear water.
- If insects, tar, or other similar deposits have accumulated on your vehicle, use MOPAR® Super Kleen Bug and Tar Remover or equivalent to remove.
- Use a high quality cleaner wax, such as MOPAR® Cleaner Wax to remove road film, stains and to protect your paint finish. Take care never to scratch the paint.

- Avoid using abrasive compounds and power buffing that may diminish the gloss or thin out the paint finish.

### CAUTION!

- **Do not use abrasive or strong cleaning materials such as steel wool or scouring powder that will scratch metal and painted surfaces.**
- **Use of power washers exceeding 1,200 psi (8 274 kPa) can result in damage or removal of paint and decals.**

### Special Care

- If you drive on salted or dusty roads or if you drive near the ocean, hose off the undercarriage at least once a month.

- It is important that the drain holes in the lower edges of the doors, rocker panels, and cargo area be kept clear and open.

- If you detect any stone chips or scratches in the paint, touch them up immediately. The cost of such repairs is considered the responsibility of the owner.

- If your vehicle is damaged due to a collision or similar cause, which destroys the paint and protective coating, have your vehicle repaired as soon as possible. The cost of such repairs is considered the responsibility of the owner.

- If you carry special cargo such as chemicals, fertilizers, de-icer salt, etc.,

## MAINTAINING YOUR VEHICLE

be sure that such materials are well packaged and sealed.

- If a lot of driving is done on gravel roads, consider mud or stone shields behind each wheel.
- Use MOPAR® Touch Up Paint or equivalent on scratches as soon as possible. Your authorized dealer has touch up paint to match the color of your vehicle.

### Wheel and Wheel Trim Care

All wheels and wheel trim, especially aluminum and chrome-plated wheels should be cleaned regularly with a mild soap and water to prevent corrosion. To remove heavy soil and/or excessive brake dust, use MOPAR® Wheel Cleaner or equivalent or select a nonabrasive, non-acidic cleaner. Do not use scouring pads, steel

wool, a bristle brush, or metal polishes. Only MOPAR® or equivalent is recommended. Do not use oven cleaner. Avoid automatic car washes that use acidic solutions or harsh brushes that may damage the wheels' protective finish.

### Stain Repel Fabric Cleaning Procedure – If Equipped

Stain Repel seats may be cleaned in the following manner:

- Remove as much of the stain as possible by blotting with a clean, dry towel.
- Blot any remaining stain with a clean, damp towel.
- For tough stains, apply MOPAR® Total Clean or a mild soap solution to a clean,

damp cloth and remove the stain. Use a fresh, damp towel to remove soap residue.

- For grease stains, apply MOPAR® Multi-Purpose Cleaner or equivalent to a clean, damp cloth and remove the stain. Use a fresh, damp towel to remove soap residue.
- Do not use any harsh solvents or any other form of protectants on Stain Repel products.

### Interior Care

#### *Instrument Panel Cover*

The instrument panel cover has a low glare surface, which minimizes reflections in the windshield. Do not use protectants



## MAINTAINING YOUR VEHICLE

or other products, which may cause undesirable reflections. Use soap and warm water to restore the low glare surface.

### ***Cleaning Interior Trim***

Interior Trim should be cleaned starting with a damp cloth, a damp cloth with MOPAR® Total Clean or equivalent, then MOPAR® Spot & Stain Remover or equivalent if absolutely necessary. Do not use harsh cleaners or Armor All®. Use MOPAR® Total Clean or equivalent to clean vinyl upholstery

### ***Cleaning Leather Upholstery***

MOPAR® Total Clean or equivalent is specifically recommended for leather upholstery.

Your leather upholstery can be best preserved by regular cleaning with a damp soft cloth. Small particles of dirt can act as

an abrasive and damage the leather upholstery and should be removed promptly with a damp cloth. Stubborn soils can be removed easily with a soft cloth and MOPAR® Total Clean or equivalent. Care should be taken to avoid soaking your leather upholstery with any liquid. Please do not use polishes, oils, cleaning fluids, solvents, detergents, or ammonia-based cleaners to clean your leather upholstery. Application of a leather conditioner is not required to maintain the original condition.

### **WARNING!**

**Do not use volatile solvents for cleaning purposes. Many are potentially flammable, and if used in closed areas they may cause respiratory harm.**

### **Cleaning Headlights**

Your vehicle has plastic headlights that are lighter and less susceptible to stone breakage than glass headlights.

Plastic is not as scratch resistant as glass and therefore different lens cleaning procedures must be followed.

To minimize the possibility of scratching the lenses and reducing light output, avoid wiping with a dry cloth. To remove road dirt, wash with a mild soap solution followed by rinsing.

Do not use abrasive cleaning components, solvents, steel wool or other aggressive material to clean the lenses.

### **Glass Surfaces**

All glass surfaces should be cleaned on a regular basis with MOPAR® Glass Cleaner

**MAINTAINING YOUR VEHICLE**

or any commercial household-type glass cleaner. Never use an abrasive type cleaner. Use caution when cleaning the inside rear window equipped with an electric defroster. Do not use scrapers or other sharp instruments that may scratch the elements.

When cleaning the rear view mirror, spray cleaner on the towel or rag that you are using. Do not spray cleaner directly on the mirror.

**Cleaning Plastic Instrument Cluster Lenses**

The lenses in front of the instruments in this vehicle are molded in clear plastic. When cleaning the lenses, care must be taken to avoid scratching the plastic.

1. Clean with a wet soft rag. A mild soap solution may be used, but do not use high

alcohol content or abrasive cleaners. If soap is used, wipe clean with a clean damp rag.

2. Dry with a soft cloth.

**Seat Belt Maintenance**

Do not bleach, dye, or clean the belts with chemical solvents or abrasive cleaners. This will weaken the fabric. Sun damage can also weaken the fabric.

If the belts need cleaning, use a mild soap solution or lukewarm water. Do not remove the belts from the car to wash them. Dry with a soft cloth.

Replace the belts if they appear frayed or worn or if the buckles do not work properly.

**Cleaning The Cupholders**

Clean with a damp cloth or towel using a mild detergent.

**FUSES**

**Interior Fuses**

Cavity	Cartridge Fuse	Mini-Fuse	Description
F100	30 Amp Pink		110V AC Inverter – If Equipped
F101		10 Amp Red	Interior Lights
F102		20 Amp Yellow	Cigar Lighter in Instrument Panel/Left Rear Power Outlet

**MAINTAINING YOUR VEHICLE**

Cavity	Cartridge Fuse	Mini-Fuse	Description
F103		20 Amp Yellow	Power Outlet in Console Bin/Power Outlet in Rear of Console
F105		20 Amp Yellow	Heated Seats – If Equipped
F106		20 Amp Yellow	Spare
F107		10 Amp Red	Rear Camera – If Equipped
F108		15 Amp Blue	Instrument Panel
F109		10 Amp Red	Climate Control/HVAC

Cavity	Cartridge Fuse	Mini-Fuse	Description
F110		10 Amp Red	Occupant Restraint Controller
F112		10 Amp Red	Spare
F114		20 Amp Yellow	Rear HVAC Blower/Motor
F115		20 Amp Yellow	Rear Wiper Motor
F116	30 Amp Pink		Rear De-froster (EBL)
F117		10 Amp Red	Heated Mirrors
F118		10 Amp Red	Occupant Restraint Controller

Cavity	Cartridge Fuse	Mini-Fuse	Description
F119		10 Amp Red	Steering Column Control Module
F120		10 Amp Red	All Wheel Drive – If Equipped
F121		15 Amp Blue	Wireless Ignition Node
F122		25 Amp Natural	Driver Door Module
F123		25 Amp Natural	Passenger Door Module
F124		10 Amp Red	Mirrors

**MAINTAINING YOUR VEHICLE**

Cavity	Cartridge Fuse	Mini-Fuse	Description
F125		10 Amp Red	Steering Column Control Module
F126		10 Amp Red	Audio Amplifier
F127		20 Amp Yellow	Trailer Tow – If Equipped
F128		15 Amp Blue	Radio
F129		15 Amp Blue	Video/DVD – If Equipped
F130		15 Amp Blue	Climate Control/ Instrument Panel

Cavity	Cartridge Fuse	Mini-Fuse	Description
F131		10 Amp Red	Passenger Assistance/ Hands Free System – If Equipped
F132		10 Amp Red	Tire Pressure Module
F133		10 Amp Red	Spare

**Underhood Fuses (Power Distribution Center)**

The power distribution center is located in the engine compartment.

art=072710833.tif NO TRANS

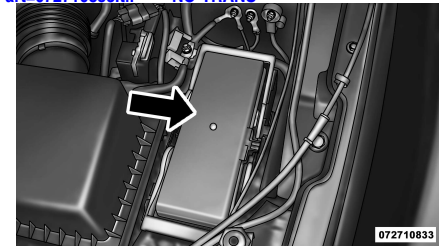

Cavity	Cartridge Fuse	Mini-Fuse	Description
F101	60 Amp Yellow		Interior Power Distribution Center Rail
F102	60 Amp Yellow		Interior Power Distribution Center Rail

**MAINTAINING YOUR VEHICLE**

Cavity	Cartridge Fuse	Mini-Fuse	Description
F103	60 Amp Yellow		Interior Power Distribution Center Rail
F105	60 Amp Yellow		Interior Power Distribution Center Rail Ignition Run Relay
F106	60 Amp Yellow		Interior Power Distribution Center Rail Run/ Accessory Relays
F139	40 Amp Green		Climate Control System Blower

Cavity	Cartridge Fuse	Mini-Fuse	Description
F140	30 Amp Pink		Power Locks
F141	40 Amp Green		Anti-Lock Brake System
F142	40 Amp Green		Glow Plugs – If Equipped
F143	40 Amp Green		Exterior Lights 1
F144	40 Amp Green		Exterior Lights 2
F145	30 Amp Pink		To Body Computer – Lamp
F146	30 Amp Pink		Spare
F147	30 Amp Pink		Spare

Cavity	Cartridge Fuse	Mini-Fuse	Description
F148	40 Amp Green		Radiator Fan Motor
F149	30 Amp Pink		Starter Solenoid
F150		25 Amp Natural	Powertrain Control Modules
F151	30 Amp Pink		Headlamp Washer Motor – If Equipped
F152		25 Amp Natural	Diesel Fuel Heater – If Equipped
F153		20 Amp Yellow	Fuel Pump

**MAINTAINING YOUR VEHICLE**

Cavity	Cartridge Fuse	Mini-Fuse	Description
F156		10 Amp Red	Brake/Electronic Stability Control Module
F157		10 Amp Red	Transfer Case Module – If Equipped
F158		10 Amp Red	Active Hood Module – If Equipped
F159		10 Amp Red	Spare
F160		20 Amp Yellow	Interior Lights
F161		20 Amp Yellow	Horn

Cavity	Cartridge Fuse	Mini-Fuse	Description
F162	50 Amp Red		Cabin Heater #1/Vacuum Pump – If Equipped
F163	50 Amp Red		Cabin Heater #2 – If Equipped
F164		25 Amp Natural	Powertrain Auto Shutdown
F165		20 Amp Yellow	Powertrain Shutdown
F166		20 Amp Yellow	Spare
F167		30 Amp Green	Powertrain Shutdown

Cavity	Cartridge Fuse	Mini-Fuse	Description
F168		10 Amp Red	Air Conditioner Clutch
F169	40 Amp Green		Emissions – Partial Zero Emissions Vehicle Motor
F170		15 Amp Blue	Emissions – Partial Zero Emissions Vehicle Actuators
F172		20 Amp Yellow	Spare
F173		25 Amp Natural	Anti Lock Brake Valves

**MAINTAINING YOUR VEHICLE**

Cavity	Cartridge Fuse	Mini-Fuse	Description
F174		20 Amp Yellow	Siren – If Equipped
F175		30 Amp Green	Spare
F176		10 Amp Red	Powertrain Control Modules
F177		20 Amp Yellow	All Wheel Drive Module – If Equipped
F178		25 Amp Natural	Sunroof – If Equipped
F179		10 Amp Red	Battery Sensor

Cavity	Cartridge Fuse	Mini-Fuse	Description
F181	100 Amp Blue		Electrohydraulic Steering (EHPS) – If Equipped
F182	50 Amp Red		Cabin Heater #3 – If Equipped
F184	30 Amp Pink		Front Wiper Motor

**VEHICLE STORAGE**

If you will not be using your vehicle for more than 21 days you may want to take steps to preserve your battery. You may:

- Remove the IOD (Ignition Off-Draw) mini-fuses from the Totally Integrated

Power Module located in the engine compartment.

- Or, disconnect the battery negative cable.

**REPLACEMENT BULBS**

All the inside bulbs are brass or glass wedge base. Aluminum base bulbs are not approved and should not be used for replacement.

**LIGHT BULBS – Interior Bulb Number**

Courtesy/Reading Lamps (Incandescent) . . . . .	578
Courtesy/Reading Lamps (Optional LED). . . . .	LED (Serviced at Authorized Dealer)
Glove Box Lamp . . . . .	194
Cargo Lamp. . . . .	579

**MAINTAINING YOUR VEHICLE**

Optional Door Map Pocket/  
Cupholder . LED (Serviced at Authorized  
Dealer)

**NOTE:** For lighted switches, see your  
authorized dealer for replacement instruc-  
tions.

<b>LIGHTS BULBS – Exterior</b>	<b>Bulb No.</b>
Low Beam Headlamp . . . . .	9006
High Beam Headlamp. . . . .	9005
Front Park/Turn Signal . . . . .	3757AK
Side Marker Lamp . . . . .	168
Front Fog Lamp . . . . .	PSX24W
Center High Mounted Stop Lamp (CHMSL) . . LED (Serviced at Authorized Dealer)	
Rear Tail/Stop Lamp . . LED (Serviced at Authorized Dealer)	
Rear Tail (Liftgate) Lamp . LED (Serviced at Authorized Dealer)	

Rear Turn Signal Lamp . . . . .	WY21W
Backup Lamp . . . . .	W21W
License Lamp . . . . .	168

**BULB REPLACEMENT**

**Front Low/High Beam Headlamp, Turn  
Signal/Park Lamp, and Side Marker  
Lamp**

1. Open the hood.

**NOTE:** It may be necessary to remove the  
air cleaner filter housing and position the  
Totally Integrated Power Module (TIPM)  
aside to replace certain lamps in the left  
headlamp housing.

2. Rotate the applicable bulb and con-  
nector assembly ¼ turn counterclockwise  
and remove the assembly from the head-  
lamp housing.

art=073302597.tif NO TRANS

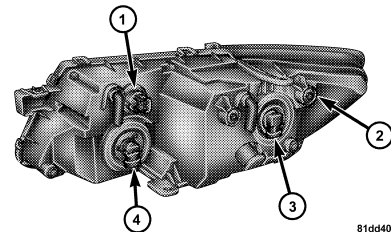

- 1 — Front Turn Signal/Park Lamp Bulb
- 2 — Side Marker Lamp Bulb
- 3 — Low Beam Headlamp Bulb
- 4 — High Beam Headlamp Bulb

3. Disconnect the bulb from the harness  
connector and then connect the replace-  
ment bulb.



MAINTAINING YOUR VEHICLE

**CAUTION!**

**Do not touch the new bulb with your fingers. Oil contamination will severely shorten bulb life. If the bulb comes in contact with any oily surface, clean the bulb with rubbing alcohol.**

4. Install the bulb and connector assembly into the headlamp housing and rotate it 1/4 turn clockwise to lock it in place.

**Front Fog Lamp**

**NOTE:** Turn the steering wheel to the right if replacing the left front fog lamp or to the left if replacing the right front fog lamp to allow for easier access to the front of the wheel well.

1. Remove the fasteners retaining the front lower wheel well access panel and remove the access panel.
2. Remove the electrical connector from the fog lamp housing.

art=073308688.tif NO TRANS

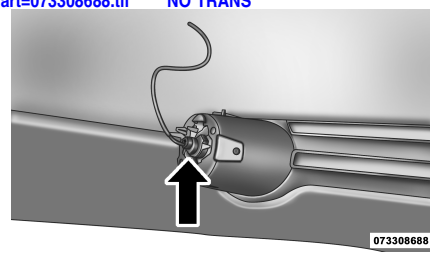

3. Squeeze the two tabs on the side of the bulb socket and pull straight out from the fog lamp.

**CAUTION!**

**Do not touch the new bulb with your fingers. Oil contamination will severely shorten bulb life. If the bulb comes in contact with an oily surface, clean the bulb with rubbing alcohol.**

4. Install the replacement bulb and connector assembly straight into the fog lamp until it locks into place.

5. Reinstall the front lower wheel well access panel and fasteners.

**Rear Turn Signal and Backup Lamp**

The taillamps are a two-piece design. The tail/stop/rear turn signal lamps are located

## MAINTAINING YOUR VEHICLE

in the rear corner body panels. The tail and backup lamps are located in the liftgate.

### Changing the Rear Turn Signal Lamp

1. Open the liftgate.
2. Remove the two fasteners from the inboard side of the taillamp housing.

art=073310814.tif NO TRANS

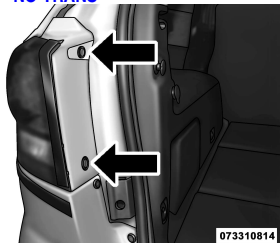

3. Carefully insert a trim stick (plastic flat-blade tool) between the body panel and

the outboard side of the taillamp housing with one hand and grasp the flange on the inboard side of the taillamp housing with the other hand. Use the trim stick and hand pressure together to disengage the taillamp housing from the vehicle.

4. Rotate the applicable bulb's electrical connector  $\frac{1}{4}$  turn counterclockwise and remove it from the taillamp housing.
5. Remove the bulb from the connector socket and install the replacement bulb.
6. Install the bulb and connector assembly into the taillamp housing and rotate the connector  $\frac{1}{4}$  turn clockwise to lock it in place.
7. Reinstall the taillamp housing and fasteners.

### Changing the Backup Lamp

1. Open the liftgate.
2. Remove the two fasteners retaining the taillamp housing to the liftgate from the inboard face of the liftgate.
3. Carefully insert a trim stick (plastic flat-blade tool) between the taillamp housing and the liftgate. Use the trim stick and hand pressure together to disengage the taillamp housing from the liftgate.
4. Rotate the applicable bulb's electrical connector  $\frac{1}{4}$  turn counterclockwise and remove it from the housing.
5. Remove the bulb from the connector socket and install the replacement bulb.

## MAINTAINING YOUR VEHICLE

6. Install the bulb and connector assembly into the housing and rotate the connector  $\frac{1}{4}$  turn clockwise to lock it in place.
7. Reinstall the taillamp housing and fasteners.

### License Plate Lamp

1. Push the small locking tab sticking out of the end of the lens toward the side of the vehicle and hold it in that position.

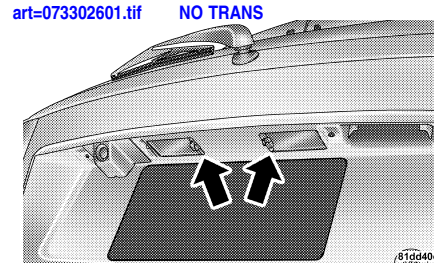

License Lamp

2. Insert a small flat-blade tool between the end of the lens with the locking tab and the surrounding housing and then pivot the tool to separate the lens from the housing.
3. Hold the lens with one hand and rotate the bulb's electrical connector  $\frac{1}{4}$  turn

counterclockwise with the other hand and then separate the bulb and connector assembly from the lens.

4. Remove the bulb from the connector socket and install the replacement bulb.
5. Install the bulb and connector assembly into the lens and rotate the connector  $\frac{1}{4}$  turn clockwise to lock it in place.
6. Insert the end of the lens without the locking tab into the housing on the liftgate and then push the opposite end of the lens into the housing, making sure it locks in the housing.

## FLUID CAPACITIES

**MAINTAINING YOUR VEHICLE**

	U.S.	Metric
<b>Fuel (Approximate)</b>		
Front Wheel Drive (FWD) Models	20.5 Gallons	77.6 Liters
All-Wheel Drive Models	21 Gallons	79.8 Liters
<b>Engine Oil with Filter</b>		
2.4L Engine (SAE 5W-20, API Certified)	4.5 Quarts	4.26 Liters
3.6L Engine (SAE 5W-30, API Certified)	6 Quarts	5.6 Liters
<b>Cooling System *</b>		
2.4L Engine and Single- or Dual-Zone Climate Control System (MOPAR® Antifreeze/Coolant 5 Year/100,000 Mile Formula or equivalent)	7.9 Quarts	7.5 Liters
2.4L Engine and Three-Zone Climate Control System (MOPAR® Antifreeze/Coolant 5 Year/100,000 Mile Formula or equivalent)	9.8 Quarts	9.3 Liters
3.6L Engine and Single- or Dual-Zone Climate Control System (MOPAR® Antifreeze/Coolant 5 Year/100,000 Mile Formula or equivalent)	9.8 Quarts	9.3 Liters
3.6L Engine and Three-Zone Climate Control System (MOPAR® Antifreeze/Coolant 5 Year/100,000 Mile Formula or equivalent)	12 Quarts	11.4 Liters
* Includes heater and coolant recovery bottle filled to MAX level.		

**FLUIDS, LUBRICANTS, AND GENUINE PARTS**

**Engine**

<b>Component</b>	<b>Fluid, Lubricant, or Genuine Part</b>
Engine Coolant	MOPAR® Antifreeze/Coolant 5 Year/100,000 Mile Formula HOAT (Hybrid Organic Additive Technology) or equivalent.
Engine Oil – 2.4L Engine	Use API Certified SAE 5W-20 Engine Oil, meeting the requirements of Chrysler Material Standard MS-6395. Refer to your engine oil filler cap for correct SAE grade.
Engine Oil – 3.6L Engine	Use API Certified SAE 5W-30 Engine Oil, meeting the requirements of Chrysler Material Standard MS-6395. Refer to your engine oil filler cap for correct SAE grade.
Engine Oil Filter	MOPAR® Engine Oil Filter or equivalent.
Spark Plugs – 2.4L Engine	ZFR5F-11 (Gap 0.044 in [1.12 mm])
Spark Plugs – 3.6L Engine	RER8ZWYCB4 (Gap 0.031 in [0.79 mm])
Fuel Selection	87 Octane

**Chassis**

<b>Component</b>	<b>Fluid, Lubricant, or Genuine Part</b>
Automatic Transmission	MOPAR® ATF+4® Automatic Transmission Fluid or equivalent licensed ATF+4® product.

**MAINTAINING YOUR VEHICLE**

<b>Component</b>	<b>Fluid, Lubricant, or Genuine Part</b>
Power Transfer Unit (PTU)	MOPAR® Gear Lubricant 75W-90 or equivalent.
Rear Drive Assembly (RDA)	MOPAR® Gear Lubricant 75W-90 or equivalent.
Brake Master Cylinder	MOPAR® DOT 3, SAE J1703 or equivalent should be used. If DOT 3 brake fluid is not available, then DOT 4 is acceptable. Use only recommended brake fluids.
Power Steering Reservoir	MOPAR® Power Steering Fluid + 4, MOPAR® ATF+4® Automatic Transmission Fluid or equivalent licensed ATF+4® product.

# SECTION 8

## MAINTENANCE SCHEDULES

- MAINTENANCE SCHEDULE ..... 388
- Required Maintenance Intervals ..... 389

## MAINTENANCE SCHEDULES

### MAINTENANCE SCHEDULE

The Scheduled Maintenance services listed in this manual must be done at the times or mileages specified to protect your vehicle warranty and ensure the best vehicle performance and reliability. More frequent maintenance may be needed for vehicles in severe operating conditions, such as dusty areas and very short trip driving. Inspection and service should also be done anytime a malfunction is suspected.

The oil change indicator system will remind you that it is time to take your vehicle in for scheduled maintenance.

On Electronic Vehicle Information Center (EVIC) equipped vehicles "Oil Change Required" will be displayed in the EVIC

and a single chime will sound, indicating that an oil change is necessary.

On Non-EVIC equipped vehicles "Change Oil" will flash in the instrument cluster odometer and a single chime will sound, indicating that an oil change is necessary.

Based on engine operation conditions the oil change indicator message will illuminate, this means that service is required for your vehicle. Have your vehicle serviced as soon as possible, within the next 500 miles (805 km).

#### NOTE:

- *The oil change indicator message will not monitor the time since the last oil change. Change your vehicles oil if it has been 6 months since your last oil change even if the oil change indicator message is NOT illuminated.*

- *Change your engine oil more often if you drive your vehicle off-road for an extended period of time.*

- *Under no circumstances should oil change intervals exceed 8,000 miles (13 000 km) or six months, whichever comes first.*

Your authorized dealer will reset the oil change indicator message after completing the scheduled oil change. If a scheduled oil change is performed by someone other than your authorized dealer, the message can be reset by referring to the steps described under "Electronic Vehicle Information Center (EVIC)/Oil Change Required" in "Understanding Your Instrument Panel" or under "Instrument Cluster Description/Odometer/Trip Odometer" in "Understanding Your Instrument Panel" for further information.



***At Each Stop for Fuel***

- Check the engine oil level about five minutes after a fully warmed engine is shut off. Checking the oil level while the vehicle is on level ground will improve the accuracy of the oil level reading. Add oil only when the level is at or below the ADD or MIN mark.
- Check the windshield washer solvent and add if required.

***Once a Month***

- Check tire pressure and look for unusual wear or damage.
- Inspect the battery and clean and tighten the terminals as required.

- Check the fluid levels of coolant reservoir, brake master cylinder, and transmission and add as needed.
- Check all lights and other electrical items for correct operation.

***At Each Oil Change***

- Change the engine oil filter.
- Inspect the brake hoses and lines.

**CAUTION!**

**Failure to perform the required maintenance items may result in damage to the vehicle.**

**Required Maintenance Intervals**

Refer to the Maintenance Schedules on the following pages for the required maintenance intervals.













**MAINTENANCE SCHEDULES**

**104,000 Miles (169,000 km) or 78 Months Maintenance Service Schedule**

- Change the engine oil and engine oil filter.
- Rotate the tires, rotate at the first sign of irregular wear, even if it occurs before 104,000 miles (169 000 km).
- Flush and replace the engine coolant if not done at 60 months.

\_\_\_\_\_  
Lecture de compteur kilométrique Date

\_\_\_\_\_  
N° du bon de travail Code du concessionnaire

\_\_\_\_\_  
Signataire autorisé du concessionnaire Chrysler Canada

**112,000 Miles (182,000 km) or 84 Months Maintenance Service Schedule**

- Change the engine oil and engine oil filter.
- Rotate the tires, rotate at the first sign of irregular wear, even if it occurs before 112,000 miles (182 000 km).
- If using your vehicle for any of the following: Dusty or off-road conditions. Inspect the engine air cleaner filter; replace if necessary.
- Replace the air conditioning filter.
- Inspect the brake linings, replace if necessary.
- Inspect the front suspension, tie rod ends and boot seals for cracks or leaks and all parts for damage, wear, improper looseness or end play; replace if necessary.

\_\_\_\_\_  
Lecture de compteur kilométrique Date

\_\_\_\_\_  
N° du bon de travail Code du concessionnaire

\_\_\_\_\_  
Signataire autorisé du concessionnaire Chrysler Canada







**152,000 Miles (247,000 km) or  
114 Months Maintenance  
Service Schedule**

- Change the engine oil and engine oil filter.
- Rotate the tires, rotate at the first sign of irregular wear, even if it occurs before 152,000 miles (247 000 km).

\_\_\_\_\_  
Lecture de compteur kilométrique Date

\_\_\_\_\_  
N° du bon de travail Code du concessionnaire

\_\_\_\_\_  
Signataire autorisé du concessionnaire Chrysler Canada

† This maintenance is recommended by the manufacturer to the owner, but is not required to maintain emissions warranty.

**WARNING!**

- **You can be badly injured working on or around a motor vehicle. Do only service work for which you have the knowledge and the right equipment. If you have any doubt about your ability to perform a service job, take your vehicle to a competent mechanic.**
- **Failure to properly inspect and maintain your vehicle could result in a component malfunction and effect vehicle handling and performance. This could cause an accident.**



# SECTION 9

## IF YOU NEED CONSUMER ASSISTANCE

• SUGGESTIONS FOR OBTAINING SERVICE FOR YOUR VEHICLE . . . . .	402	• MOPAR® PARTS . . . . .	404
• IF YOU NEED ASSISTANCE . . . . .	402	• REPORTING SAFETY DEFECTS . . . . .	404
• WARRANTY INFORMATION . . . . .	404	• PUBLICATION ORDER FORMS . . . . .	404
		• TIRE QUALITY GRADES . . . . .	405

## IF YOU NEED CONSUMER ASSISTANCE

### SUGGESTIONS FOR OBTAINING SERVICE FOR YOUR VEHICLE

#### Prepare For The Appointment

If you're having warranty work done, be sure to have the right papers with you. Take your warranty folder. All work to be performed may not be covered by the warranty. Discuss additional charges with the service manager. Keep a maintenance log of your vehicle's service history. This can often provide a clue to the current problem.

#### Prepare A List

Make a written list of your vehicle's problems or the specific work you want done. If you've had an accident or work done that is not on your maintenance log, let the service advisor know.

#### Be Reasonable With Requests

If you list a number of items and you must have your vehicle by the end of the day, discuss the situation with the service advisor and list the items in order of priority. At many authorized dealers, you may obtain a rental vehicle at a minimal daily charge. If you need a rental, it is advisable to make these arrangements when you call for an appointment.

### IF YOU NEED ASSISTANCE

The manufacturer and its authorized dealers are vitally interested in your satisfaction. We want you to be happy with our products and services.

Warranty service must be done by an authorized dealer. We strongly recommend that you take the vehicle to an authorized dealer. They know your vehicle

the best, and are most concerned that you get prompt and high quality service. The manufacturer's authorized dealers have the facilities, factory-trained technicians, special tools, and the latest information to ensure the vehicle is fixed correctly and in a timely manner.

This is why you should always talk to an authorized dealer's service manager first. Most matters can be resolved with this process.

- If for some reason you are still not satisfied, talk to the general manager or owner of the authorized dealership. They want to know if you need assistance.
- If an authorized dealership is unable to resolve the concern, you may contact the manufacturer's customer center.

**IF YOU NEED CONSUMER ASSISTANCE**

Any communication to the manufacturer's customer center should include the following information:

- Owner's name and address
- Owner's telephone number (home and office)
- Authorized dealership name
- Vehicle Identification Number (VIN)
- Vehicle delivery date and mileage

**Chrysler Group LLC Customer Center**

P.O. Box 21-8004

Auburn Hills, MI 48321-8004

Phone: (800) 423-6343

**Chrysler Canada Inc. Customer Center**

P.O. Box 1621

Windsor, Ontario N9A 4H6

Phone: (800) 387-9983

**In Mexico contact:**

Av. Prolongacion Paseo de la Reforma,  
1240

Sante Fe C.P. 05109

Mexico, D. F.

In Mexico City: 5081-7568

Outside Mexico City: 1-800-505-1300

**Customer Assistance For The Hearing Or Speech Impaired (TDD/TTY)**

To assist customers who have hearing difficulties, the manufacturer has installed special TDD (Telecommunication Devices for the Deaf) equipment at its customer center. Any hearing or speech impaired customer, who has access to a TDD or a conventional teletypewriter (TTY) in the United States, can communicate with the manufacturer by dialing 1-800-380-CHRY.

Canadian residents with hearing difficulties that require assistance can use the special needs relay service offered by Bell Canada. For TTY teletypewriter users, dial 711 and for Voice callers, dial 1 800 855-0511 to connect with a Bell Relay Service operator.

## IF YOU NEED CONSUMER ASSISTANCE

### Service Contract

You may have purchased additional coverage with an extended service contract. Chrysler Canada Inc. stands fully behind its service contracts. Be sure that the one you buy is a genuine Canada Inc. service contract. We are not responsible for other companies' contracts. If you purchased a contract other than a genuine Chrysler Canada Inc. service contract and you have a problem, you will have to contact the administrator of that contract for resolution. Look for a phone number in the contract documents.

We appreciate that you have made a major investment when you purchased the vehicle. An authorized dealer has also made a major investment in facilities, tools, and training to assure that you are absolutely delighted with the ownership

experience. You'll be pleased with their sincere efforts to resolve any warranty issues or related concerns.

### WARRANTY INFORMATION

See the Warranty Information Booklet for the terms and provisions of Chrysler Canada Inc. warranties applicable to this vehicle and market.

### MOPAR® PARTS

MOPAR® fluids, lubricants, parts, and accessories are available from an authorized dealer. They are recommended for your vehicle in order to help keep the vehicle operating at its best.

### REPORTING SAFETY DEFECTS

If you believe that your vehicle has a safety defect, you should contact the Cus-

tomers Service Department immediately. Canadian customers who wish to report a safety defect to the Canadian government should contact Transport Canada, Motor Vehicle Defect Investigations and Recalls at 1-800-333-0510 or go to <http://www.tc.gc.ca/securiteroutiere/>

### PUBLICATION ORDER FORMS

To order the following manuals, you may use either the website or the phone numbers listed below. Visa, Mastercard, American Express, and Discover orders are accepted. If you prefer mailing your payment, please call for an order form.

**NOTE:** A street address is required when ordering manuals (no P.O. Boxes).

- Service Manuals



**IF YOU NEED CONSUMER ASSISTANCE**

These comprehensive Service Manuals provide the information that students and professional technicians need in diagnosing/troubleshooting, problem solving, maintaining, servicing, and repairing Chrysler Group LLC vehicles. A complete working knowledge of the vehicle, system, and/or components is written in straightforward language with illustrations, diagrams, and charts.

- *Diagnostic Procedure Manuals*

Diagnostic Procedure Manuals are filled with diagrams, charts and detailed illustrations. These practical manuals make it easy for students and technicians to find and fix problems on computer-controlled vehicle systems and features. They show exactly how to find and correct problems the first time, using step-by-step troubleshooting and

drivability procedures, proven diagnostic tests and a complete list of all tools and equipment.

- *Owner's Manuals*

These Owner's Manuals have been prepared with the assistance of service and engineering specialists to acquaint you with specific Chrysler Group LLC vehicles. Included are starting, operating, emergency and maintenance procedures as well as specifications, capabilities and safety tips.

**Call toll free at:**

- **1-800-890-4038 (U.S.)**
- **1-800-387-1143 (Canada)**

Or

**Visit us on the Worldwide Web at:**

- **[www.techauthority.com](http://www.techauthority.com)**

**TIRE QUALITY GRADES**

The following describes tire grading categories. The specific grade rating assigned by the tire's manufacturer in each category is shown on the sidewall of the tires on your vehicle.

**Treadwear**

The Treadwear grade is a comparative rating, based on the wear rate of the tire when tested under controlled conditions on a specified government test course. For example, a tire graded 150 would wear one and one-half times as well on the government course as a tire graded 100. The relative performance of tires depends upon the actual conditions of their use, however, and may depart significantly

## IF YOU NEED CONSUMER ASSISTANCE

from the norm due to variations in driving habits, service practices, and differences in road characteristics and climate.

### Traction Grades

The Traction grades, from highest to lowest, are AA, A, B, and C. These grades represent the tire's ability to stop on wet pavement, as measured under controlled conditions on specified government test surfaces of asphalt and concrete. A tire marked C may have poor traction performance.

### WARNING!

**The traction grade assigned to this tire is based on straight-ahead braking traction tests, and does not include acceleration, cornering, hydroplaning, or peak traction characteristics.**

### Temperature Grades

The temperature grades are A (the highest), B, and C, representing the tire's resistance to the generation of heat and its ability to dissipate heat, when tested under controlled conditions on a specified indoor laboratory test wheel. Sustained high temperature can cause the material of the tire to degenerate and reduce tire life, and excessive temperature can lead to sudden tire failure. The grade C corresponds to a level of performance, which

all passenger car tires must meet under the Motor Vehicle Safety Standard No. 109. Grades B and A represent higher levels of performance on the laboratory test wheel, than the minimum required by law.

### WARNING!

**The temperature grade for this tire is established for a tire that is properly inflated and not overloaded. Excessive speed, under-inflation, or excessive loading, either separately or in combination, can cause heat buildup and possible tire failure.**

**SECTION**

**10**

**INDEX**

**IF YOU NEED CONSUMER ASSISTANCE** 